

NACHI

CUTTING TOOLS

DRILLS
END MILLS
TAPS

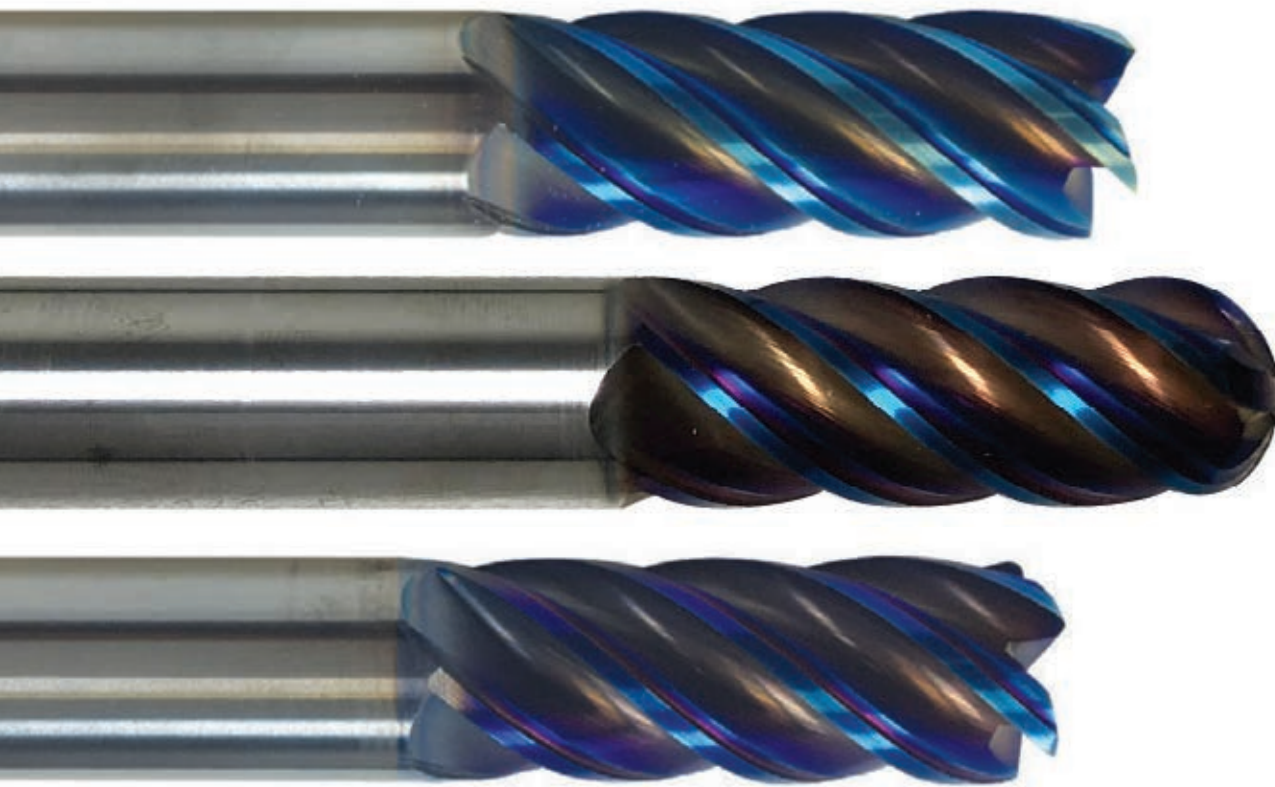



AQUA V MILL 5 FLUTE
YOUR CUTTING TOOL SOLUTION

NAACHI
CUTTING TOOLS



Contributing to Progress in the World of Product Manufacturing

NACHI Cutting Tools

NACHI-FUJIKOSHI CORP. is a pioneer of precision cutting tools in Japan and one of the leading manufacturers of tools worldwide. No manufacturer of cutting tools anywhere in the world, exercises greater control over the quality of its products than NACHI. NACHI quality starts with the material itself because the High Speed Steel, premium Cobalt High Speed Steel, Powder High Speed Steel, and Cermet we use comes from our own mills. The technology of the coating, such as Mixed Component multi-layer coating and Diamond coating (thin film diamond) has been developed specifically for our cutting tools.

Cutting tools are basic products for the machine industries. Successful performance of machine tools cannot be expected without precise cutting tools and high quality. NACHI pursues the highest quality 100% of the time. NACHI is the first Japanese cutting tool manufacturer to be awarded the prestigious honor of the Deming Award for Quality.

NACHI AMERICA'S CUTTING TOOL DIVISION produces drills, endmills and taps designed to meet and exceed the exacting requirements of the industry's highest-precision machine tools. NACHI has long been a leader not only in tool design but in coatings that add durability and extend cutting life. Our tools are built to perform with precision and provide our customers with efficient, cost-effective solutions.

Ph: 888-340-8665

Fax: 888-383-8665

ml-nai.toolsengineer@nachi.com

NachiAmerica.com

**For additional Cutting Tool Options
visit our parent company site:**

Nachi-Fujikoshi.co.jp



North America Headquarters - Greenwood, Indiana



Manufacturing & Re-Grind Facilities, Greenwood, Indiana



Sales Office & Warehouse, Concord, Ontario, Canada



Sales Office & Warehouse, Cerritos, California



Sales Office & Warehouse, Queretaro, Mexico

We have a history of ninety years as a world-famous integrated manufacturer, with the renowned brand "NACHI". With the continuous production system, from high class special steels to finished products, our well-coordinated techniques stand high in public estimation.

Japan Head Office
 Shiodome, Sumitomo Bldg, 17F1-9-2 Higashi-Shinbashi,
 Minato-ku, Tokyo, JAPAN, 105-0021
 Phone: (03) 5568-5111
 Fax: (03) 5568-5206

Toyama Manufacturing Plant
 1-1-1 Fujikoshi-Honmae, Toyama, JAPAN 930-8511
 Phone: 81-(0) 76-423-5100
 Fax: 81-(0) 76-493-5221

Nachi America Inc. - Headquarters
 715 Pushville Rd, Greenwood, Indiana 46143, U.S.A.
 Phone: (317) 530-1001
 Fax: (317) 530-1011

Nachi Tool America Inc.
 717 Pushville Rd, Greenwood, Indiana 46143, U.S.A.
 Phone: (317) 535-0320
 Fax: (317) 535-0983

Nachi America Inc. LA Office
 12652 Alondra Blvd, Cerritos, California 90703, U.S.A.
 Phone: 562-802-0055

Nachi Canada Inc.
 89 Courtland Ave., Unit #2, Concord, Ontario, CANADA L4K 3T4
 Phone: (905) 660-0088
 Fax: (905) 660-1146

Nachi Mexicana S.A. de C.V.
 Calle Tequisquipan 2, Aerotech Industrial Park, Localidad
 Galeras Municipio de Colon, Queretaro, MEXICO C.P76295
 Phone: 52-442-153-2424
 Fax: 52-442-153-2435



Greenwood Facilities Technical Center & Regrind Services

Nachi America has a testing center devoted to R&D of new and existing product, as well as providing test cuts for customer applications. As your cutting tool provider, Nachi America is dedicated to providing the best data and solution to your manufacturing process. Nachi America's facility in Greenwood, IN has the capacity to regrind tools. Contact your local sales representative for more information or contact a tools engineer through Technical Support.



Common Formulas

$$\text{SFM} = \text{RPM} \times \text{Diameter} \times 0.2618$$

$$\text{RPM} = (\text{SFM} \times 3.82) / \text{Diameter}$$

$$\text{Inch Per Minute} = \text{IPR} \times \text{RPM}$$

$$\text{Inch Per Minute} = \text{IPT} \times \# \text{ of Flutes} \times \text{RPM}$$

$$\text{Inch Per Revolution} = \text{IPM} / \text{RPM}$$

$$\text{Inch Per Tooth} = \text{IPM} / (\text{RPM} \times \# \text{ of Flutes})$$

$$\text{Cutting \%} = \text{IPR} / \text{Diameter} \times 100$$

$$\text{Material Removal Rate} = \text{WOC} \times \text{DOC} \times \text{IPM}$$

$$\text{Mill Tapping Feedrate} = 1/\text{TPI} \times \text{RPM}$$



Technical Assistance

ml'nai.toolsengineer@nachi.com

(888) 340-8665

(317) 530-1003

www.nachi-america.com/cutting-tools/

Regrind Facilities:

Regrinds are available on most of the NACHI line of cutting tools.

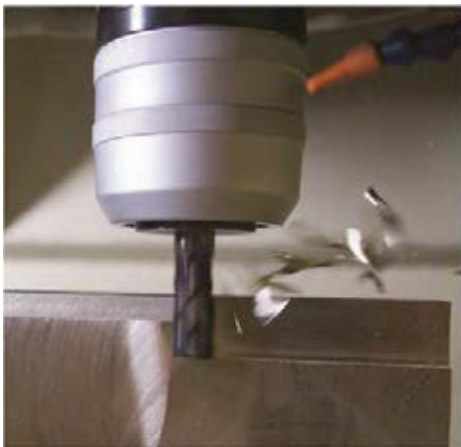

Scan here for a quick link to our **Online Speeds & Feeds Calculator**



Other Divisions of NACHI America

NACHI Gear Technology

715 Pushville Road
Greenwood, IN 46143
Ph: (317) 530-1004
Fax: (317) 530-1014
Email: ml.nai.gearsales@nachi.com
www.nachiamerica.com/Gear-Tools

NACHI Hydraulics

715 Pushville Road
Greenwood, IN 46143
Ph: (800) 622-4410
Fax: (888) 383-8665
Email: ml-nai.hydraulics@nachi.com
www.nachiamerica.com/Hydraulics

NACHI Specialty Steel

715 Pushville Road
Greenwood, IN 46143
Ph: (317) 530-1005 or (800) 526-6281
Fax: (317) 530-1015
Email: ml-nai.specialtysteel@nachi.com
www.nachiamerica.com/specialty-steel

NACHI Robotics

46200 W. 12 Mile Road
Novi, MI 48377
Ph: (248) 305-6545
Fax: 248-305-6542
Email: sales@nachirobotics.com
www.nachiamerica.com/Robotics

NACHI Machine Tools

46200 W. 12 Mile Road
Novi, MI 48377
(248) 305-6545
(248) 305-6542
Email: ml-nai.machinetools@nachi.com
www.nachiamerica.com/Machine-Tools

NACHI Bearings

715 Pushville Road
Greenwood, IN 46143
Ph: (317) 530-1002
Toll Free: (888) 340-2747
Fax: (317) 530-1013
Email: ml.nai.bearings@nachi.com
www.nachiamerica.com/Machine-Tools

TECHNICAL DATA

General technical information regarding materials
and icons used throughout the catalog
p. 6-9

CARBIDE DRILLS

Images, technical information, EDP numbers,
Feeds & Speeds for all Carbide Drill products
p. 30-43, 50-109, 151-154

HSS DRILLS

Images, technical information, EDP numbers,
Feeds & Speeds for all High Speed Steel Drill products
p. 44-57, 110-150, 151-154

CARBIDE END MILLS

Images, technical information, EDP numbers,
Feeds & Speeds for all Carbide End mill products
p. 156-188, 205-208

HSS END MILLS

Images, technical information, EDP numbers,
Feeds & Speeds for all High Speed Steel End mill products
p. 189-204, 209-211

TAPS

Images, technical information, EDP numbers,
Feeds & Speeds for all Tap products
p. 214-256

REFERENCE

General reference charts for material symbols
and hardness for all cutting tool products
p. 257-259

INDEX

Page index for all individual products:
Drill, End Mills, Taps
p. 261-262

TECHNICAL DATA

CARBIDE DRILLS

HSS DRILLS

CARBIDE END MILLS

HSS END MILLS

TAPS

REFERENCE

INDEX

Material and Heat Treatment

Clean Steel

Material and heat treatment are major factors in determining the performances of the **High-Speed Steel** tool. To provide high quality HSS tools, NACHI-FUJIKOSHI has a steel mill to manufacture the HSS steels conforming to individual requirements for our in-house use as well as for outside sales.



Electric arc furnace

Clean Heat Treatment

In the field of heat treatment, we are producing and marketing vacuum heat treatment furnaces, which are highly evaluated among users both in Japan and abroad. Further, through technical tie-ups with Sumitomo Electric Industries Co., Ltd., we use cemented carbide materials best suited to individual requirements.



Vacuum carbonizing furnace, vacuum degreasing washer, coating equipment and coating process

High-Speed Tool

Main high-speed tools and their applications

Classification	Steel Type Symbol			Chemical Component						Application
	JIS	AISI	NACHI	C	Mo	W	Cr	V	Co	
High-Speed Steel	SKH10	T 15	HS55T	1.5		12	4	5	5	Basic steel type, cutting tool Drill, broach, others in general Drill, gear cutting tool, others in general Cutting tool, others in general Cutting tool, others in general Tool material End milling cutter and others End milling cutter, tap
	SKH51	M 2	SKH51	0.85	5	6	4	2		
	—	M33	HM33	0.9	9.5	1.5	4	1.2	8	
	—	M34	HM34	0.9	8	2	4	2	8	
	SKH55	M35	HS53M	1.05	5.5	6	4	2.5	5	
	SKH57	—	HS93R	1.25	3.5	10	4	3.5	10	
	SKH59	M42	HS96H	1.1	9.5	1.5	4	1.2	8	
Powdered High-Speed Steel			HS97R	1.1	5.5	7.5	4	1.8	9	
			FAX18	1.1	9.5	1.5	4	1.2	8	Saws and others
			FAX31	1.3	5.5	6	4	3		General
			FAX38	1.3	5	6	4	3	8	Gear cutting tool, tap, others in general
			FAX55	1.6		12	4	5	5	Gear cutting tool, broach, others in general
Alloy Tool Steel			FAX90	2.6	3.5	10	4	8.5	10	General (high alloy material)
	SKS 7		SKS 7	1.15		2.2	0.3			Hack saw, etc. Molding tools including dies and molds
	SKD11		SKD11	1.5	1		12	0.4		
	SKD61		SKD61	0.4	1.3		5	1	Si1	

Effects of major alloy components

W : Hard double carbide is formed to ensure improved wear resistance

Mo : Fine carbide and improved toughness to ensure improved wear resistance

Cr : Tissue stabilization factor (upgraded solubility)

V : Extended and improved wear resistance of secondary carbon

C : Enhanced carbon formation factor and hardening properties

Co : Best suited to heavy-duty cutting due to improved heat resistance

Material and Heat Treatment

Characteristics of Various Tool Materials

It is important that tool materials are characterized by excellent resistance to chipping or breakage. Selection is made from among various types of tool materials in conformity to the workpiece and machining method. NACHI's integrated production system, covering the entire range from materials to tool, produces tool materials meeting each of your requirements.

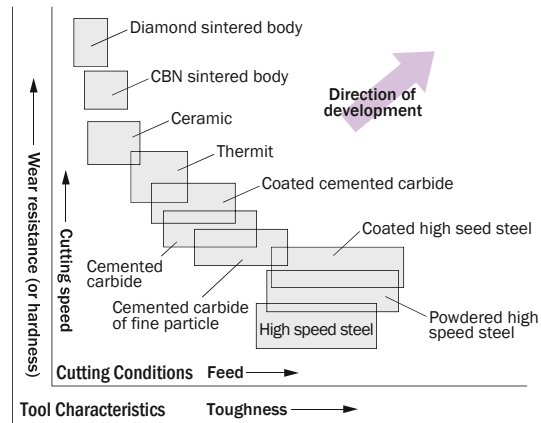

Type	Symbol	(Example)	Production Method	Features
Carbon Tool Steel	SK □	SK 3	Tool steel where carbon is put into iron to enable hardening.	Less expensive, but low hardness at a high temperature.
Alloy Tool Steel	SKS □ SKD □	SKS 7 SKD 11	Tool steel with its wear resistance improved by alloy steel such as iron, Cr and W.	
High Speed Steel	SKH □	SKH 51 SKH 55	Tool steel with wear resistance and toughness improved by hard carbide created by mixing W, Mo, Cr and V with iron.	The steel type with much Co content is called cobalt high speed tool characterized by excellent heat resistance.
Powdered High Speed Steel	NACHI symbol FAX □	FAX 38 FAX 55	Fine powder of the high speed steel sintered by the powder metallurgy. This method can also be used to manufacture the type of steep containing such components as V and Co.	The tissue is minute, uniform and tough. Further, excellent wear resistance is provided by such components.
Cemented Carbide	K □ P □	K 10 P 20	The major component is W. It is manufactured by sintering the TiC, TaC and Co (bonding agent) according to powder metallurgy method.	Very hard at a high temperature and excellent in wear resistance, but chips easily.
Ultrafine Grain Cemented Carbide	Z □	Z 20	Cemented carbide characterized in that the particle diameter of carbide such as W, Ti and Ta does not exceed 1 micron.	The toughness is higher than that of cemented carbide, but wear resistance is lower.
Thermit	NACHI symbol NAX □	NAX T NAX LL	The main components are carbide such as Ti and Ta, nitride and carbonitride. They are sintered with Ni and Co (binder) by powder metallurgy to produce Thermit.	Excellent in resistance to wear, heat and deposition, but susceptible to chipping. Used for high-speed cutting.
Ceramic			A sintered body (porcelain). Available in two types; alumina type mainly consisting of Al ₂ O ₃ and silicon type mainly consisting of Si ₂ N ₄ .	Excellent wear resistance but poor toughness.
CBN Sintered Body	NACHI symbol BM □ BC □	BM 10 BC 30B	Manufactured by sintering the powder of CBN, the hardest second only to diamond, at a high temperature under super high pressure. Excellent hardness even at a high temperature.	Reaction with metal occurs very rarely. Characterized by excellent stability at a high temperature.
Diamond Sintered Body	NACHI symbol DM □	DM 10 DM 10F	A polycrystalline body formed by sintering powdered diamond at a high temperature under super high pressure. Characterized by excellent hardness.	Chemically stable to the workpiece made of material other than iron.

Hardness of High-Hardness Material

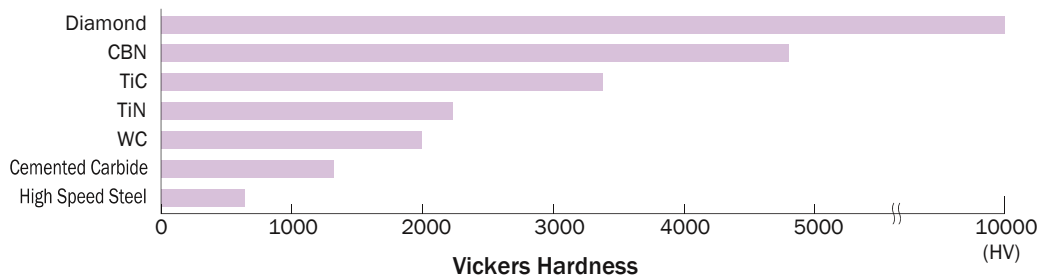







































GUIDE TO MARK (TOOL SPECIFICATION)

	Mark	Explanation		Mark	Explanation
Coating		G (TiN) Coating	Flutes of Drills		Normal Helix Flutes
		SG (TiCN multi layer) Coating			High Helix Flutes
		AG (TiAlN multi layer) Coating			Low Helix Flutes
		AQ (ALCRN Base, multi layer) Coating			Variable Helix Flutes
		AQ Mill (AlTiN Base, nano layer) Coating	Drill Dimension		Point Angle of Drills
		GS (TiAlN multi layer) Coating			Drill Length is from Center Point
		DLC Coating			Drill Length is from Corner Point
		Diamond Coating			Oil-hole Drills
		REVO D Coating			Three Flutes Drills
Tool Materials		High Speed Steels	Lip Relief of Drills		Shape of Lip Relief is Conical
		Cobalt High Speed Steels 			Shape of Lip Relief is Two Rake
		Fine Melting HSS 			Shape of Lip Relief is Three Rake
		High Grade Powder HSS 	Thinning of Drills		S-type Thinning
		Vanadium HSS			Notch Thinning
		Vanadium HSS			X-type Thinning
		Cobalt/Vanadium HSS 			
		Tungsten Carbide 			XH-type Thinning
Helix Angle		Helix Angle		2Rake Relief & X-type Thinning	
				2Rake Relief & XR-type Thinning	
				3 Flutes Drills & 3F-type Thinning	

 **WARNING:** This product can expose you to chemicals including cobalt, which is known to the State of California to cause cancer. For more information go to www.P65Warnings.ca.gov

GUIDE TO MARK (TOOL SPECIFICATION)

	Mark	Explanation		Mark	Explanation	
Tolerance of Drills Dia.		Tolerance of Drills Diameter is js6	Flutes of End Mills		4 Flutes Radius End mills (Center Cut)	
		Tolerance of Drills Diameter is h7			2 Flutes Ball Nose End mills (Center Cut)	
		Tolerance of Drills Diameter is h8			3 Flutes Ball Nose End mills (Center Cut)	
Tolerance of Shank Dia.		Tolerance of Shank Diameter			4 Flutes Ball Nose End mills (Center Cut)	
Flutes of End Mills		Sharp Corner Type End Mills			5 Flutes Ball Nose End mills (Center Cut)	
		2 Flutes Square End Mills (Center Cut)			6 Flutes Ball Nose End mills (Center Cut)	
		3 Flutes Square End Mills (Center Cut)		Type of Taps		Cutting Taps
		4 Flutes Square End Mills (Center Cut)				Forming Taps
		4 Flutes Square (Center Cut)		Flutes of Taps		Straight Flutes Taps
		5 Flutes Square End Mills (Center Cut)				Spiral Pointed Taps
		6 Flutes Square End Mills (Center Cut)			Normal Helix Flutes Taps	
		6 Flutes Square (Center Cut)			High Helix Flutes Taps	
		8 Flutes Square (Center Cut)			Low Helix Flutes Taps	
		4 Flutes Square End Mills (with Center Hole)	Chamfer of Taps			Chamfer Length is 2.5P to 3P
		5 Flutes Square End Mills (with Center Hole)			Chamfer Length is 4P to 5P (for through hole)	
		6 Flutes Square End Mills (with Center Hole)			Chamfer Length is 1.5P (for blind hole)	
		Multiple Flutes (over 8) Square End mills (with Center Hole)			Chamfer Length is 7P to 10 P (for through hole)	
		2 Flutes Radius End Mills (Center Cut)			Chamfer Length is 2.5P	
					Cutting Taps for Taper Pipe	
					Cutting Taps for Straight Pipe	



NACHI

WHERE INNOVATION AND QUALITY MEET

VISUAL INDEX

DRILLS

ENDMILLS

TAPS



Specs/Sizes
Speeds/Feeds

AQUA REVO DRILL STUB

Carbide REVO D h7 135° 30° h6 2.0-16.0

Material Coating Dia. Tol. Point Angle Helix Shank Dia. Tol. Size Range

List 9860 Metric Sizes
List 9861 Fractional Sizes



P 58-59
P 59

AQUA REVO DRILL REGULAR

Carbide REVO D h7 135° 30° h6 2.0-16.0

Material Coating Dia. Tol. Point Angle Helix Shank Dia. Tol. Size Range

List 9862 Metric Sizes
List 9863 Fractional Sizes



P 60-61
P 61

AQUA REVO DRILL OIL HOLE 3D

DIN Standard

Carbide REVO D h7 140° 26° ~30° h6 3.0-16.0 OIL HOLE

Material Coating Dia. Tol. Point Angle Helix Shank Dia. Tol. Size Range OIL HOLE

List 9872 Metric Sizes
List 9873 Fractional Sizes



P 62-63
P 63

AQUA REVO DRILL OIL HOLE 3D

JIS Standard

Carbide REVO D h7 140° 26° ~30° h6 3.0-16.0 OIL HOLE

Material Coating Dia. Tol. Point Angle Helix Shank Dia. Tol. Size Range OIL HOLE

List 9864 Metric Sizes



P 64-65
P 65

AQUA REVO DRILL OIL HOLE 5D

DIN Standard

Carbide REVO D h7 140° 26° ~30° h6 3.0-16.0 OIL HOLE

Material Coating Dia. Tol. Point Angle Helix Shank Dia. Tol. Size Range OIL HOLE

List 9874 Metric Sizes
List 9875 Fractional Sizes



P 66-67
P 67

AQUA REVO DRILL OIL HOLE 5D

JIS Standard

Carbide REVO D h7 140° 26° ~30° h6 3.0-16.0 OIL HOLE

Material Coating Dia. Tol. Point Angle Helix Shank Dia. Tol. Size Range OIL HOLE

List 9866 Metric Sizes



P 68-69
P 69

AQUA REVO DRILL OIL HOLE 8D

Carbide REVO D h7 140° 26° ~30° h6 3.0-16.0 OIL HOLE

Material Coating Dia. Tol. Point Angle Helix Shank Dia. Tol. Size Range OIL HOLE

List 9868 Metric Sizes
List 9869 Fractional Sizes



P 70-71
P 71

Specs/Sizes
Speeds/Feeds

AQUA DRILL EX OIL HOLE 10D



LIST 9612 Metric sizes



P 72

P 75

AQUA DRILL EX OIL HOLE 15D



LIST 9614 Metric sizes
LIST 9615 Fractional sizes



P 73

P 75

AQUA DRILL EX OIL HOLE 20D



LIST 9616 Metric sizes
LIST 9617 Fractional sizes

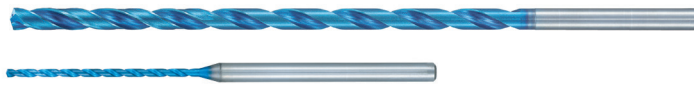

P 74

P 75

AQUA DRILL EX OIL HOLE 25D



LIST 9618 Metric sizes
LIST 9619 Fractional sizes



P 76

P 78

AQUA DRILL EX OIL HOLE 30D



LIST 9620 Metric sizes
LIST 9621 Fractional sizes



P 77

P 78

AQUA DRILL EX OIL HOLE 40D



LIST 9626 Metric sizes
LIST 9627 Fractional sizes



P 79

P 80

Specs/Sizes
Speeds/Feeds

AQUA DRILL EX OIL HOLE PILOT

Carbide AQ EX 24° ~30° h7 150° h6 OIL HOLE Pilot Drill for L9612, L9614, L9616, L9618, L9620, L9628

List 9622 Metric Sizes
List 9623 Fractional Sizes



P 81-82
P 82

AQUA DRILL EX OIL HOLE 3 FLUTE 3D

Carbide AQ EX 24° ~30° js6 140° h6 OIL HOLE

List 9826



P 83
P 84

AQUA DRILL EX OIL HOLE 3 FLUTE 5D

Carbide AQ EX 24° ~30° js6 140° h6 OIL HOLE

List 9820



P 84
P 84

AQUA REVO DRILL MICRO 5D

Carbide REVO D SEE FORTHOSE AFTER TABLE 120° 135° 30° h6 0.50-1.99 OIL HOLE

List 9878 Metric sizes



P 86-87
P 87

AQUA REVO DRILL MICRO 10D

Carbide REVO D SEE FORTHOSE AFTER TABLE 120° 135° 30° h6 0.50-1.99 OIL HOLE

List 9880 Metric sizes



P 88-89
P 89

AQUA DRILL MICRO

Carbide AQ HELIX N 140° GRAKE-X

List 9544 Metric Sizes



P 90-91
P 92

Specs/Sizes
Speeds/Feeds

AQUA DRILL EX OIL HOLE MICRO 3D



List 9604

Metric sizes



P 93

P 93

AQUA DRILL EX OIL HOLE MICRO 5D



List 9606

Metric sizes



P 93

P 93

DLC DRILL MICRO



List 9524

Metric Sizes



P 94

P 95

DLC DRILL REGULAR



List 9520

Metric Sizes



P 94

P 95

CARBIDE DRILLS

AQUA DRILL EX FLAT STUB LENGTH

Specs/Sizes
Speeds/Feeds



List 9610 Metric Sizes
List 9611 Fractional Sizes



P 96-97
P 99

AQUA DRILL EX FLAT RADIUS



List 9830 Metric Sizes
List 9831 Fractional Sizes



P 98
P 99

AQUA DRILL EX FLAT REGULAR



List 9818 Metric Sizes
List 9819 Fractional Sizes



P 100
P 102

AQUA DRILL EX FLAT LONG SHANK



List 9816 Metric Sizes
List 9817 Fractional Sizes



P 101
P 102

AQUA DRILL EX FLAT OIL HOLE 3D



List 9812 Metric Sizes
List 9813 Fractional Sizes



P 103-104
P 104

AQUA DRILL EX FLAT OIL HOLE 5D



List 9814 Metric Sizes
List 9815 Fractional Sizes



P105-106
P 106

AQUA DRILL EX FLAT SUPER STUB



List 9628 ***Japan Stock Item**



P 107-108
P 108

AQUA DRILL EX STARTING DRILL

Specs/Sizes
Speeds/Feeds



List 9624



P 109
P 109

Specs/Sizes
Speeds/Feeds

AG STARTING DRILL



List 6502



P 110
P 109

AG STARTING DRILL EXTENDED LENGTH



List 6504



P 110
P 109

SG-ESS DRILL MICRO



List 7572P

Metric Sizes



P 111-116
P 116

SG-ESS DRILL STUB LENGTH



List 7572P

Metric Sizes

List 7573P

Fractional, Wire, Letter Sizes



P 111-116
P 116

SG-ESR DRILL



List 7574P

Metric Sizes

List 7575P

Fractional, Wire, Letter Sizes



P 117-118
P 119

*Replacing AG-SUS Drill L6594P, 6595P and SG-ES Drill L7570P, L7571P

SG DRILL OIL HOLE



List 7596P

Metric Sizes

List 7591P

Fractional Sizes



P 120
P 120

AG POWER LONG DRILL



List 6540P Metric Sizes
List 6541P Fractional Sizes



P 121
P 122

DLC DRILL



List 544 Metric Sizes



P 123
P 124

STRAIGHT SHANK DRILLS

STRAIGHT SHANK DRILL SCREW MACHINE LENGTH



List 561 General Purpose
Letter, Fractional & Wire Gauge Sizes



P 123
P 148



List 561P General Purpose
Fractional & Wire Gauge Sizes



P 126
P 148



List 563 Aircraft NAS907-C
Letter, Fractional & Wire Gauge Sizes



P 127
P 148



List 6563 Aircraft NAS907-C
Letter, Fractional & Wire Gauge Sizes



P 128
P 148

Specs/Sizes
Speeds/Feeds

STRAIGHT SHANK DRILL JOBBER LENGTH



List 501A General Purpose
Letter, Fractional & Wire Gauge Sizes



P 129
P 148



List 500 Metric Sizes



P 130
P 148



List 501 General Purpose
Letter, Fractional & Wire Gauge Sizes



P 131
P 148



List 6501 Aircraft NAS907-J
Letter, Fractional & Wire Gauge Sizes



P 132
P 148

STRAIGHT SHANK DRILL COBALT



List 6520 Metric Sizes



P 133
P 148

STRAIGHT SHANK DRILL G STANDARD



List 520P Metric Sizes



P 134
P 148

STRAIGHT SHANK DRILL JOBBER LENGTH



List 501P General Purpose
Fractional & Wire Gauge Sizes



P 135
P 148



List 517P Parabolic
Fractional & Wire Gauge Sizes



P 136
P 149

STRAIGHT SHANK DRILL TAPER LENGTH



List 531 General Purpose
Fractional Sizes



P 137
P 148



List 6531 General Purpose
Fractional Sizes



P 138
P 148



List 545P Parabolic Style
Fractional Sizes



P 139
P 149

STRAIGHT SHANK DRILL EXTRA LENGTH



List 551 Fractional Sizes



P 140
P 149



List 6551 Parabolic Tang Drive
Fractional Sizes



P 141
P 149

STRAIGHT SHANK DRILL OIL HOLE



List 581 Fractional Sizes



P 142
P 150

TAPER SHANK DRILLS

Specs/Sizes
Speeds/Feeds

TAPER SHANK DRILL REGULAR LENGTH



List 601 Fractional Sizes



P 143
P 150

TAPER SHANK DRILL EXTRA LENGTH



List 651 Fractional Sizes



P 144
P 150

TAPER SHANK DRILL OIL HOLE



List 683 Fractional Sizes



P 145
P 150

HSS DRILLS

SPECIALTY DRILLS

Specs/Sizes
Speeds/Feeds

SILVER AND DEMING DRILL



List 575 Fractional Sizes



P 146
P 150

DRILL SET JOBBER LENGTH

List 599 Letter, Fractional & Wire Gauge Sizes



P 147

TECHNICAL REFERENCE / DRILLS

P 151-154

HIGH PERFORMANCE END MILLS

AQUA V MILL FOUR FLUTE



List 9701 Fractional Sizes
List 9702 Metric Sizes



Specs/Sizes
Speeds/Feeds

P 162
P 169-170

AQUA V MILL FOUR FLUTE CORNER RADIUS



List 9703 Fractional Sizes
List 9704 Metric Sizes



P 163
P 169-170

AQUA V MILL FIVE FLUTE



List 9705 Fractional Sizes
List 9706 Metric Sizes



P 164
P 169

AQUA V MILL FIVE FLUTE CORNER RADIUS



List 9707 Fractional Sizes
List 9708 Metric Sizes



P 165 -166
P 169

AQUA V MILL FIVE FLUTE BALL NOSE



List 9709 Fractional Sizes
List 9710 Metric Sizes

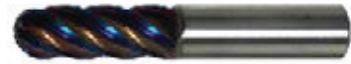

P 168
P 169

AQUA V MILL FIVE FLUTE NECK RELIEF



List 9727 Fractional Sizes



P 167
P 169

AQUA MILL HARD



List 9711 Fractional Sizes
List 9712 Metric Sizes



P 171
P 175-176

AQUA MILL HARD CORNER RADIUS



List 9713 Fractional Sizes
List 9714 Metric Sizes



P 172
P 175-176

Specs/Sizes
Speeds/Feeds

AQUA MILL HARD BALL NOSE



List 9715 Fractional Sizes
List 9716 Metric Sizes



P 173
P 177-178

AQUA HARD MILL CORNER RADIUS NECK RELIEF



List 9729 Fractional Sizes
List 9730 Metric Sizes



P 174
P 175-176

ALH MILL



List 9717 Fractional Sizes
List 9718 Metric Sizes



P 179
P 185-188

ALH MILL CORNER RADIUS



List 9719 Fractional Sizes
List 9720 Metric Sizes



P 180-181
P 185-188

ALH MILL BALL NOSE



List 9721 Fractional Sizes
List 9722 Metric Sizes



P 182
P 185-188

ALH MILL NECK RELIEF



List 9723 Fractional Sizes

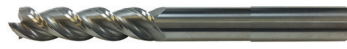

P 183
P 185-188

ALH MILL BALL NOSE NECK RELIEF



List 9725 Fractional Sizes



P 184
P 185-188

CARBIDE END MILLS

Specs/Sizes
Speeds/Feeds

DLC MILL



List 6231HD Fractional Sizes



P 189

P 189

AG-MILL ROUGHING



List 6485 Fractional Sizes



P 190

P 190

AG-MILL HEAVY



List 6403 Fractional Sizes



P 191

P 191

ROUGHING AND FINISHING (HEAVY DUTY) END MILL



List 6367 Fractional Sizes



P 192

P 193



List 6367X Fractional Sizes



P 192

P 193

ROUGHING (HOG) END MILL



List 6303 Fractional Sizes



P 194

P 196



List 6303X Fractional Sizes



P 194

P 196



List 6307 Fractional Sizes



P 195

P 196

Specs/Sizes
Speeds/Feeds

TWO FLUTE END MILL SINGLE END



List 6231 Fractional Sizes



P 197

P 199



List 6231X Fractional Sizes



P 197

P 199

TWO FLUTE END MILL LONG SINGLE END



List 6233 Fractional Sizes



P 198

P 199

TWO FLUTE END MILL SINGLE END



List 6230 Metric Sizes



P 198

P 199

FOUR FLUTE END MILL SINGLE END



List 6210 Metric Sizes



P 200

P 203

MULTI FLUTE END MILL REGULAR SINGLE END, CENTER CUTTING



List 6211M Fractional Sizes



P 201

P 203



List 6211X Fractional Sizes



P 201

P 204

MULTI FLUTE END MILL LONG SINGLE END, CENTER CUTTING



List 6213 Fractional Sizes



P 202

P 203

TECHNICAL REFERENCE / END MILLS

P 205-211

HIGH PERFORMANCE TAPS

Specs/Sizes
Speeds/Feeds

SGSP-DIN TAP SPIRAL FLUTED



List 6800 Metric Sizes
List 6801 Machine Screw and Fractional Sizes



P 222-223
P 222

SGPO-DIN TAP SPIRAL POINTED



List 6802 Metric Sizes
List 6803 Fractional and Machine Screw Sizes



P 224-225
P 224

SG LO TAP SPIRAL FLUTED



List 6958 Metric Sizes
List 6959 Fractional and Machine Screw Sizes



P 226-227
P 226

DLC TAFLET TAP THREAD FORMING



List 6956 Metric Sizes
List 6955 Fractional Sizes
List 6957 Machine Screw Sizes



P 228-229
P 228

VIPER TAFLET FOR STEEL



List 996 Metric Sizes

VIPER TAFLET



P 230
P 231



List 995 Fractional Sizes
List 995 Machine Screw Sizes



P 231-232
P 231-232

VTP TAP SPIRAL FLUTED



List 980 Metric Sizes
List 981 Fractional Sizes
List 983 Machine Screw Sizes

VTP TAPS



P 233
P 235
P 234
P 235

VTP TAP SPIRAL POINTED



List 982 Metric Sizes
List 971 Fractional Sizes
List 973 Machine Screw Sizes



P 233
P 235
P 235
P 235

STANDARD TAPS

Specs/Sizes
Speeds/Feeds

STANDARD HAND TAP



List 911 Fractional Sizes



P 236

P 244



List 913 Machine Screw Size



P 237

P 244

STANDARD TAP SPIRAL POINTED



List 921 Fractional Sizes



P 238

P 244

STANDARD HAND TAP FOR CAST IRON



List 969 Fractional Sizes



P 238

P 244

STANDARD TAP SPIRAL POINTED



List 923 Machine Screw Sizes



P 239

P 244

STANDARD HAND TAP



List 910 Metric Sizes



P 240

P 244

STANDARD TAP SPIRAL POINTED



List 920 Metric Sizes



P 240

P 244

TAPS

TAPER PIPE TAPS

Specs/Sizes
Speeds/Feeds

TAPER PIPE TAP STRAIGHT FLUTED



List 941 (NPT)
List No. 941D (NPTF)



P 241
P 244

TAPER PIPE TAP INTERRUPTED



List No. 943 (NPT)
List No. 943D (NPTF)



P 241
P 244

TAPER PIPE TAP SPIRAL FLUTED



List 947 (NPT)
List No. 947D (NPTF)



P 242
P 244

STRAIGHT PIPE TAP STRAIGHT FLUTED



List No. 945 (NPS)
List No. 945D (NPSF)



P 242
P 244

TAPER PIPE TAP SHORT PROJECTION



List 959 (NPT)
List No. 959D (NPTF)



P 243
P 244

TAPER PIPE TAP 6" EXTENSION



List 957 (NPT)



P 243
P 244

TECHNICAL REFERENCE / TAPS

P 244-256

DRILLS



REVOlutionizing the World of Product Manufacturing

AQUA REVO DRILLS

LIST 9860, 9861 / LIST 9862, 9863

AQUA REVO Drills Stub/Regular

All New Material, Design and Coating Dramatically improves all functions of drilling

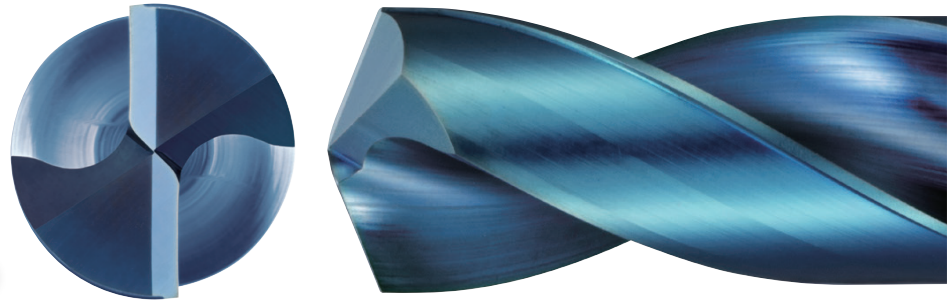
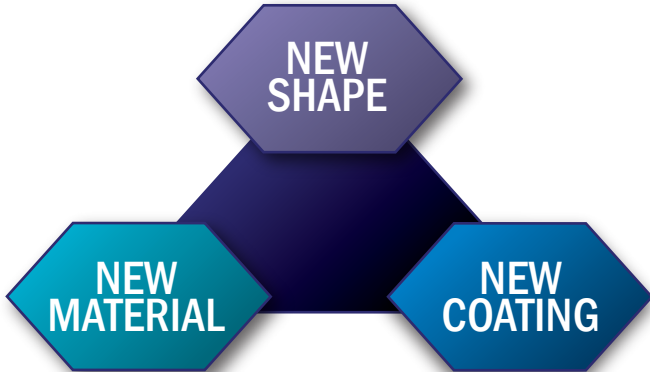

NEW MATERIAL

- Development of a carbide material adds both hardness and toughness
- Improves wear resistance and chipping resistance

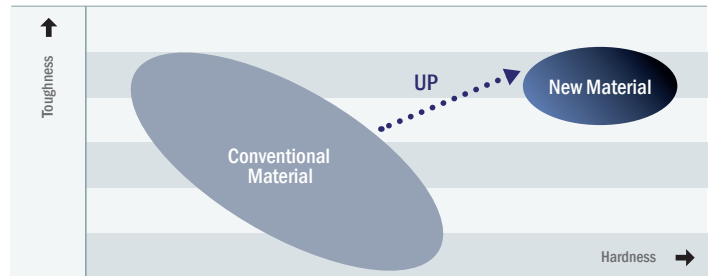

NEW SHAPE

- New straight cutting edge breaks up cutting stress
- Improved strength against corner chipping

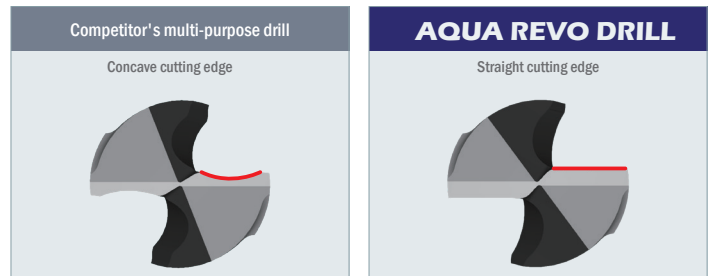

NEW COATING

- Newly developed REVO-D coating suitable for drilling multiple materials
- High oxidation resistance and wear resistance
- Low friction and smooth chip evacuation from super smooth surface treatment

Super smooth surface treatment

AlCr-based and AlTi-based films are stacked at the nano level

High strength cemented carbide base material

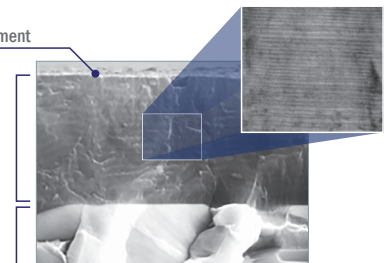

TECHNICAL INFORMATION / AQUA REVO DRILLS

LONG TOOL LIFE

Durability and stability to exceed other drills

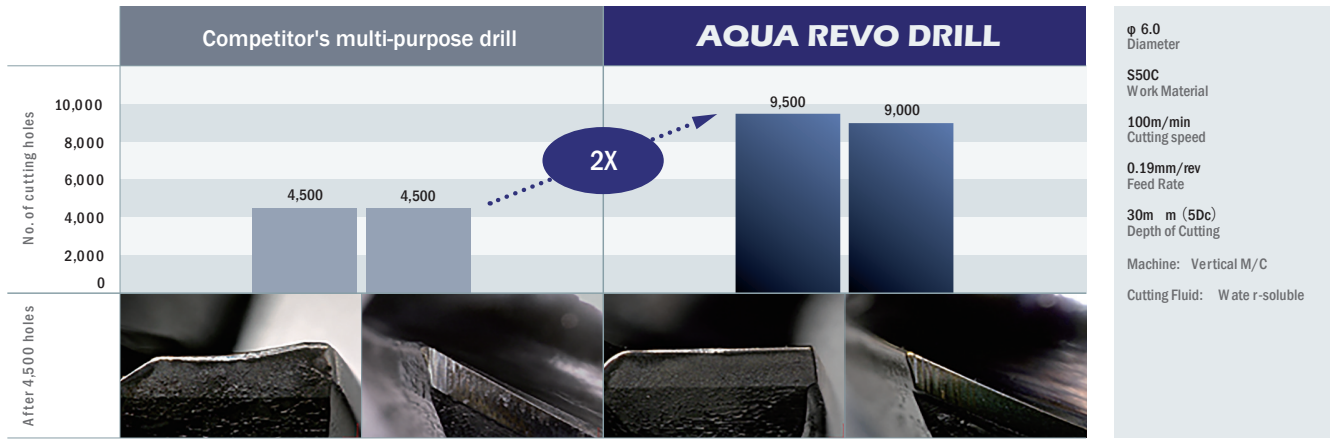

HIGH EFFICIENCY

High performance even with increased speed and feed, extending tool life and shortening processing time

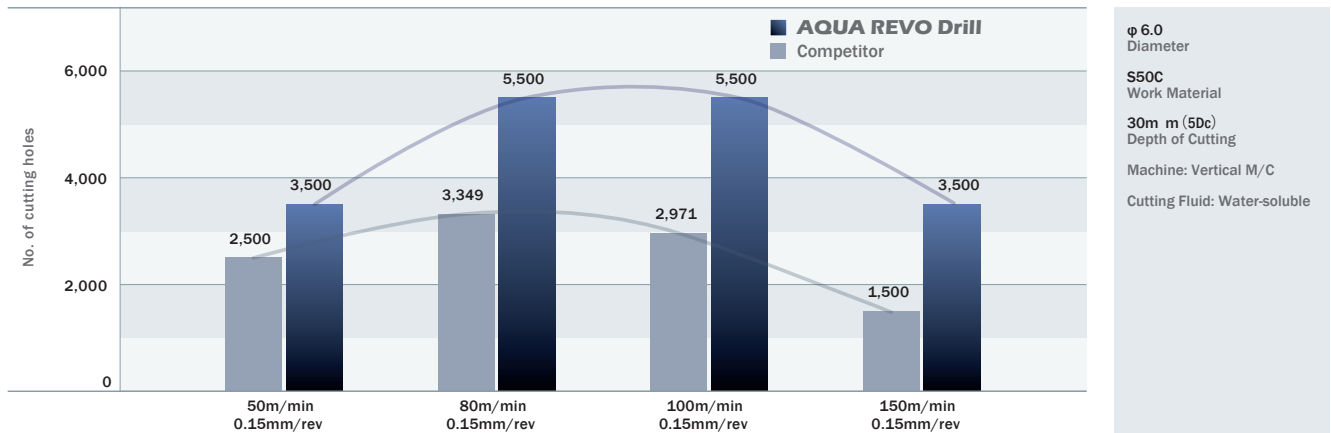

MULTI-PURPOSE

Able to cut high hardness materials and difficult-to-cut materials, while maintaining high quality processing and increasing efficiency

φ 6.0 Diameter
Machine: Vertical M/C
Cutting Fluid: Water-soluble



REVOlutionizing the World of Product Manufacturing

AQUA REVO DRILLS OIL HOLE

LIST 9864, 9866, 9868, 9869, 9872, 9873, 9874, 9875

AQUA REVO Drills Oil Hole 3D, 5D, 8D

All New Oil Hole Concept in our REVO Material, Design and Coating

The use of Fluid Analysis Greatly Improves Cooling and Lubrication

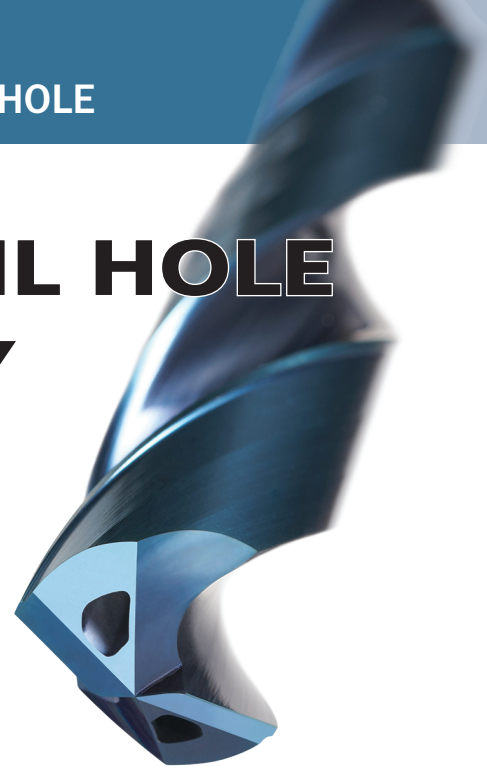

New Oil Hole Design REVO Power Cooler

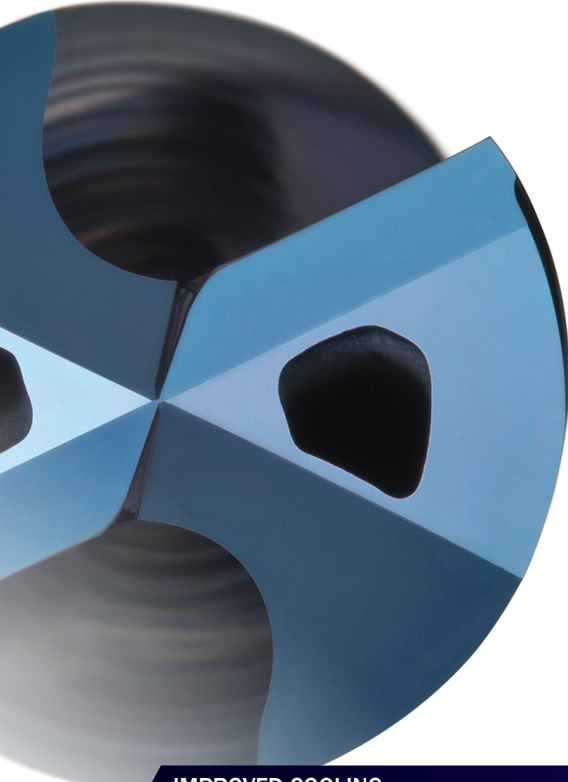

OVERWHELMING FLOW RATE

Cross-sectional area and coolant amount of the oil hole are more than twice that of conventional.

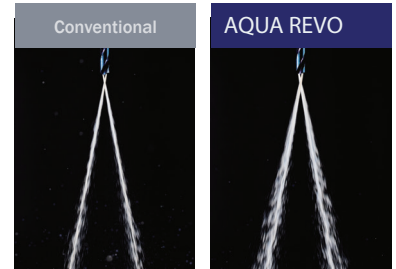

Amount per 1 minute
Drill: $\phi 8.0$ Equipment: 1.5MPa
Rotation: 4,800min⁻¹

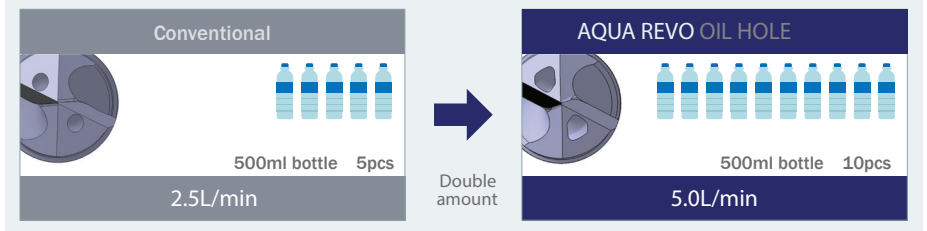

IMPROVED COOLING

Increased flow rate and flow velocity around corners and thinning

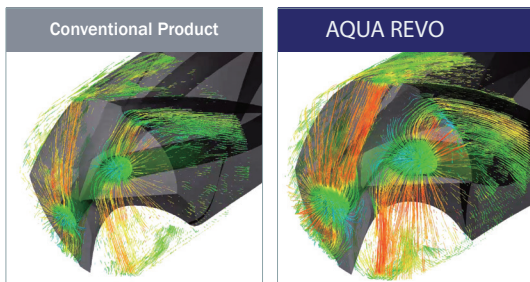

SUPPRESSES WORK HARDENING

Tool life and accuracy will improve after drilling process

During the drilling process the work material can harden. Because of Nachi's new oil hole design, users can see a decrease in work hardening, prolonging tool life.

Work Material: SUS304

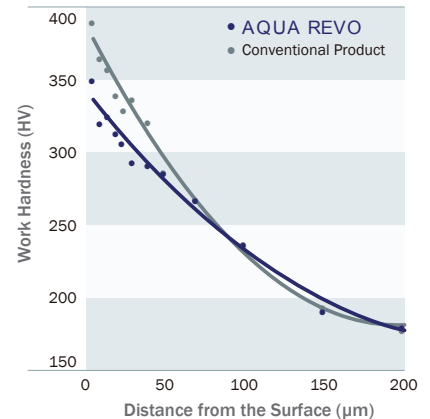

TECHNICAL INFORMATION / AQUA REVO DRILL OIL HOLE

EXCELLENT TOOL LIFE & WEAR SUPPRESSION

Durability and stability surpasses other drills

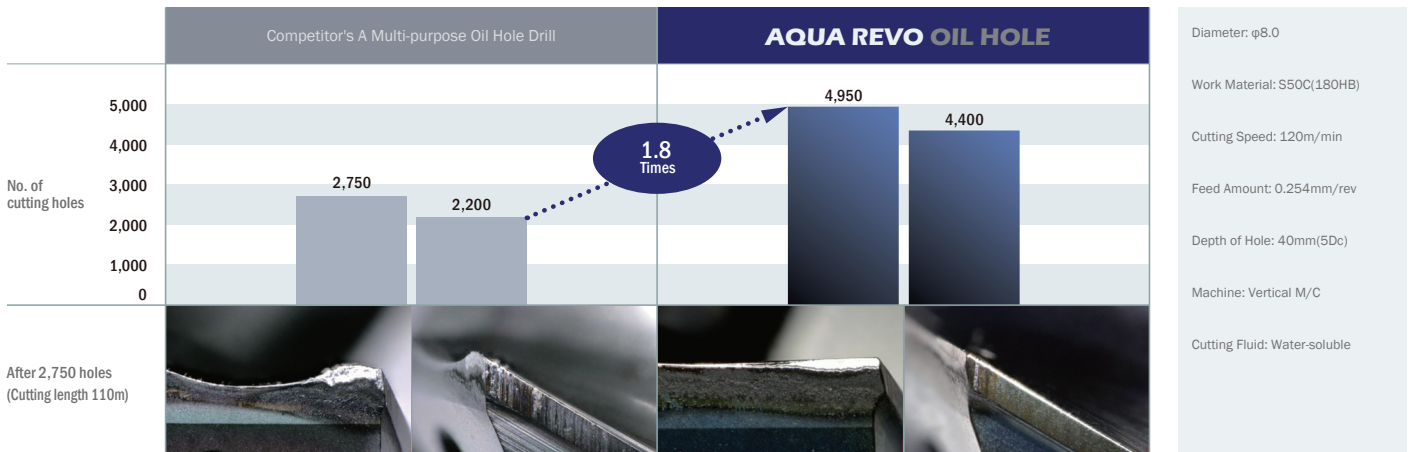

INCREDIBLE TOOL LIFE EVEN IN STAINLESS STEEL

Although it is a multi-purpose drill, even compared to drills for Stainless steel, Nachi achieved more than twice as many holes

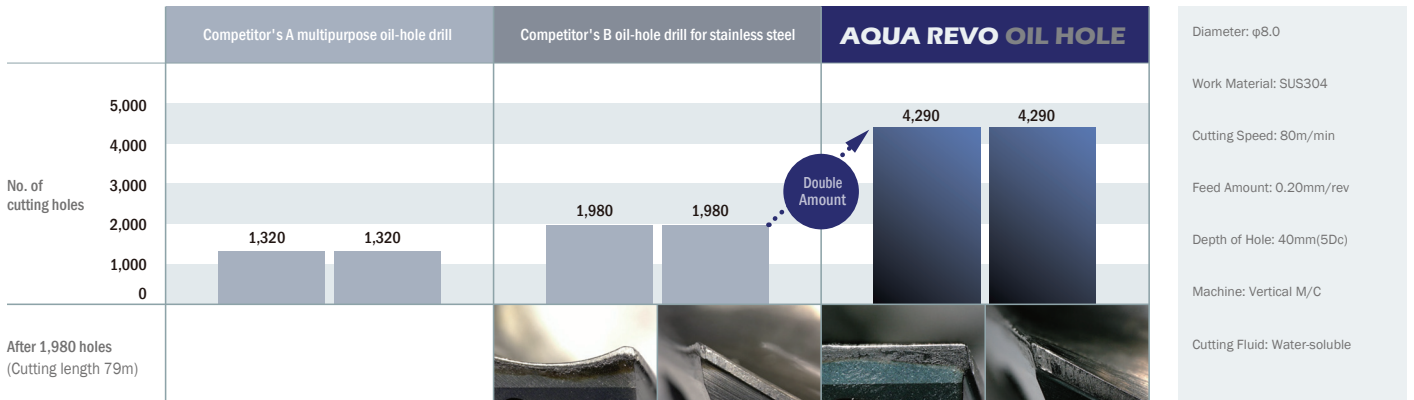

Compatible with a wide range of materials from Structural steel to Stainless steel and Hardened steel

SELECTION BY WORKING MATERIAL

AQUA REVO Oil Hole 3D, 5D, 8D	Structural Steel	Carbon Steel	Alloy Steel Heat-treated Steel	Mold Steel Hardened Steel	Hardened Steel			Stainless Steel			Titanium Alloy	Nickel Based Alloy	Cast Iron	Aluminum Alloy
	SS400	S45C S50C	SCM SCr	30~40 HRC	40~50 HRC	50~57 HRC	58~65 HRC	SUS304 SUS316	SUS420	SUS630	Ti-6Al-4V		FC FCD	AC ADC
	◎	◎	◎	◎	◎	○	—	◎	◎	◎	○	○	◎	○

◎: Excellent ○: Good —: Not recommended

UNIQUE REVO POWER COOLER DESIGN

CARBIDE DRILLS

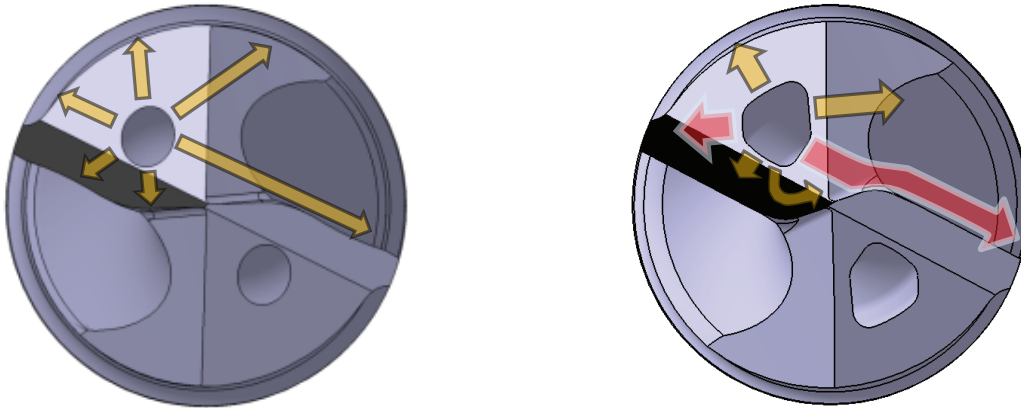

The REVO Power Cooler's unique design directs coolant to the cutting edge. This results in longer tool life by keeping the drill cooler when drilling.

REVO POWER COOLER VS. CONVENTIONAL DESIGN

Conventional

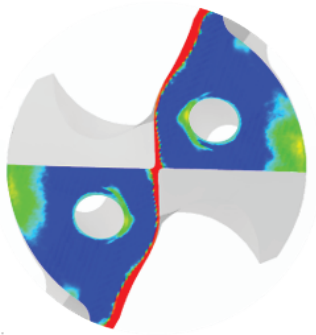

→ Area with low cooling effect

AQUA REVO POWER COOLER

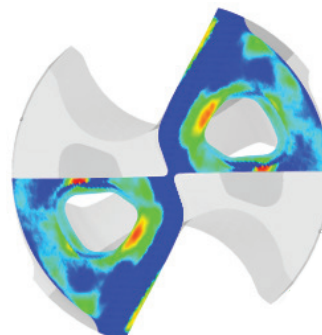

→ Area with high cooling effect

During a thermal analysis, Nachi's REVO Power Cooler proved to keep the cutting edge cooler than conventional oil hole drills.

SUCCESS CASE #1 - TOOL LIFE

L9874 REVO POWER COOLER 5XD - 316L

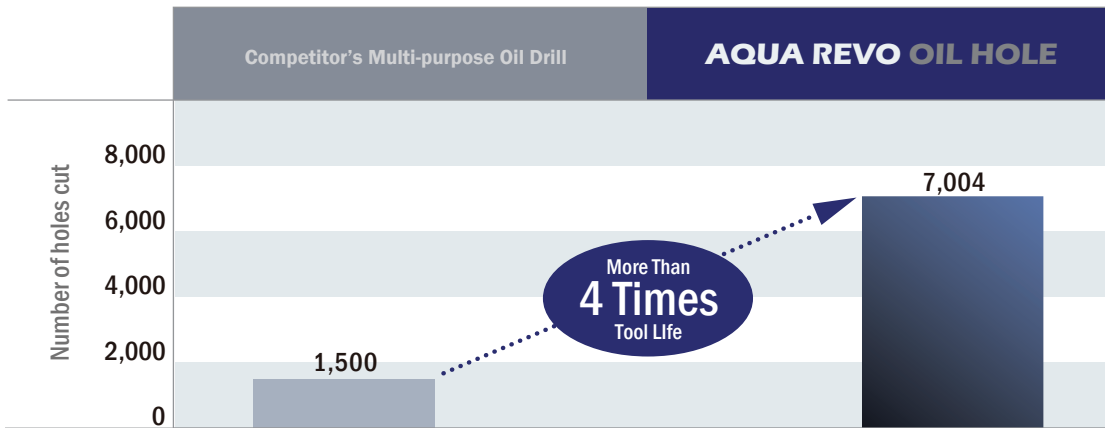

Application
Diameter: ϕ 9.7
Work Material: 316L SS
Cutting Speed: 130 SFM
Feed Rate: 0.0027 IPR
Depth of Hole: 30.2 mm
Machine: Vertical M/C
Cutting Fluid: Water-soluble

AQUA REVO Wear Results After 7004 Holes

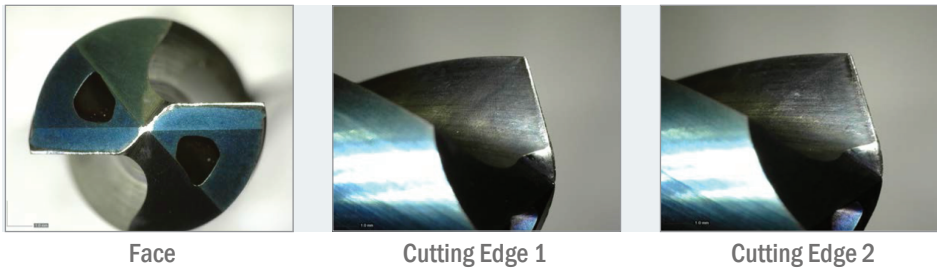

AQUA REVO was able to increase tool life more than 400%

CARBIDE DRILLS

SUCCESS CASE #2 - TOOL LIFE & PART CYCLE TIME

L9872 REVO POWER COOLER 3XD - MONEL K500

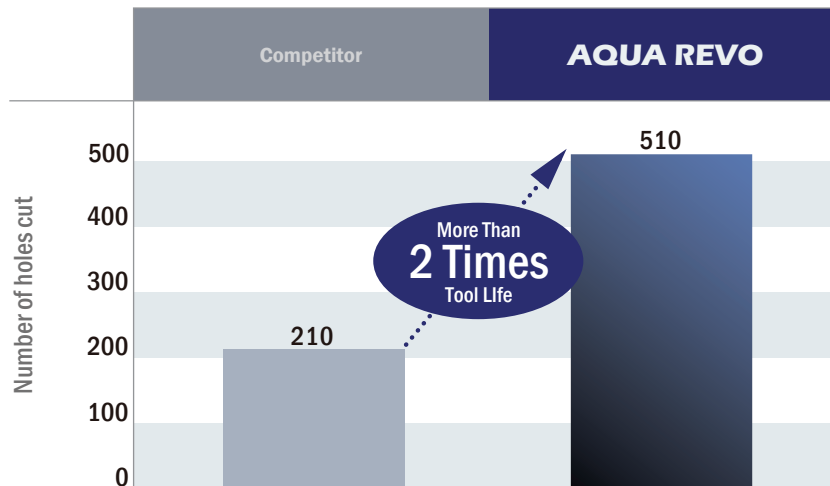

Application	
Diameter: ϕ 8.5mm	
Work Material: Monel K500	
Depth of Hole: 12.6mm	
Machine: Vertical M/C	
Cutting Fluid: Water-soluble	
Competitor Parameters	Nachi Parameters
Cutting Speed: 50 SFM	Cutting Speed: 50 SFM
Feed Amount: 0.0024 IPR	Feed Amount: 0.0043 IPR



AQUA REVO was able to more than double tool life and reduce part cycle time by one minute

AQUA REVO DRILL MICRO

AQRVDM 5D/10D



Product Info Video

CARBIDE DRILLS

REVOLUTIONIZING THE WORLD OF MANUFACTURING

- New lineup of small diameter sizes for the AquaREVO Drill series
- Achieves "long tool life that is hard to break" and "stable cutting with little dispersion" required for small-diameter drills

MATERIAL

Newly developed carbide material for micro drill that is hard to break. Both hardness and toughness are improved by using ultra-fine particles carbide and original component design.

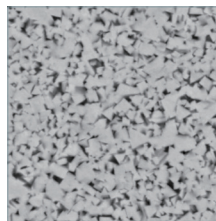

Microstructure
Material with ultra-fine particle type for micro drill

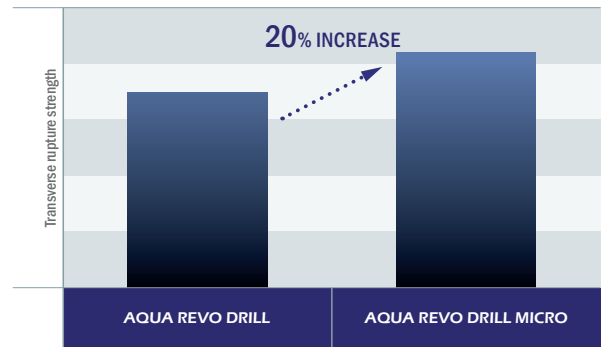

GEOMETRY

Achieves a drill that is hard to break with a flute shape that emphasizes rigidity and chip evacuation.

AquaREVO Drills Micro has 1.2 times the breaking torque of competitor's drill.

The breaking torsion torque

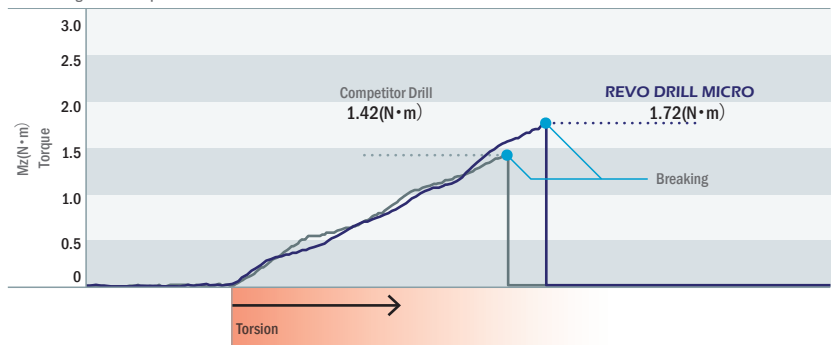

SHAPE

Stable tool life with accurate film thickness control - even with small diameter drills.

Super smooth surface treatment reduces resistance during cutting and improves smooth chip evacuation.

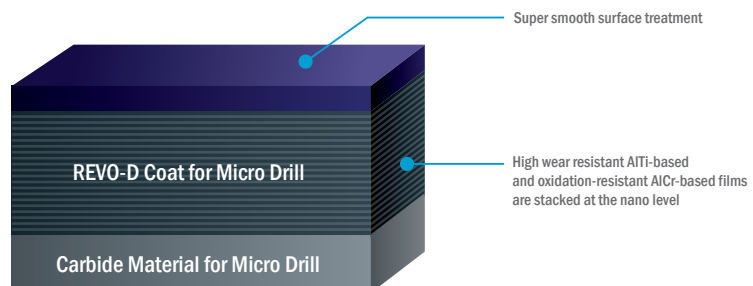

Cross-sectional structure of coating film for micro drill

TECHNICAL INFORMATION - AQUA MICRO DRILL

LONG TOOL LIFE

Hard to break even when drilling small diameter holes

S50C

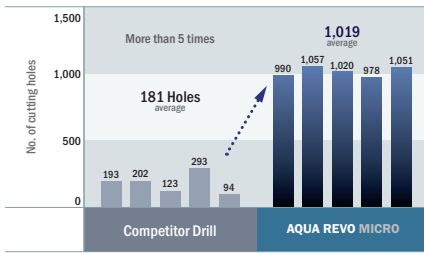

φ 0.5
 Diameter
S50C (180HB)
 Work Material
40m/min
 Cutting Speed
0.03mm/rev
 Feed Rate
5mm (10DC)
 Depth of Cutting: Blind hole
0.1mm (0.2DC)
 Step feed
 Cutting Fluid: Water-soluble
 M/C
 Machine: Vertical M/C

SUS304

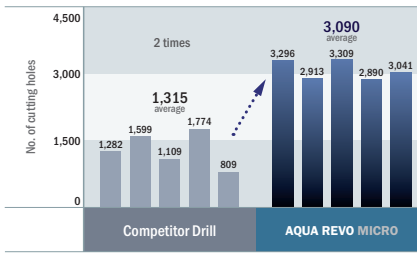

0.5
 Diameter
SUS304
 Work Material
9m/min
 Cutting Speed
0.02mm/rev
 Feed Rate
5mm (10DC)
 Depth of Cutting: Blind hole
0.1mm (0.2DC)
 Step feed
 Cutting Fluid: Water-soluble
 M/C
 Machine: Vertical M/C

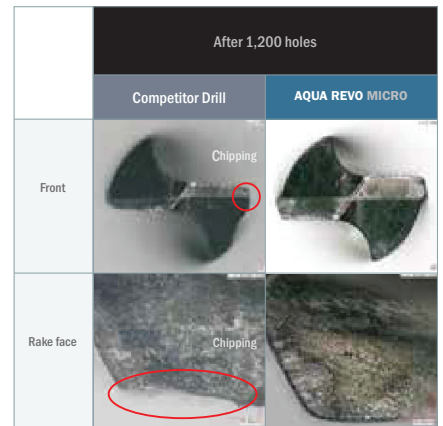

CARBIDE DRILLS

HIGH-PRECISION

Exceptional Hole Position Accuracy

AquaREVO Drill Micro is designed with optimized centripetal properties and tool rigidity to achieve hole position accuracy within 15 μm.

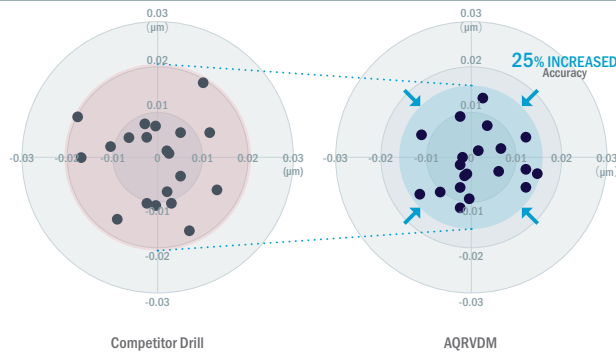

0.5
 Diameter
SUS304
 Work Material
9m/min
 Cutting Speed
0.02mm/rev
 Feed Rate
5mm (10DC)
 Depth of Cutting: Blind hole
0.1mm (0.2DC)
 Step feed
 Cutting Fluid: Water-soluble
 M/C
 Machine: Vertical M/C

MULTI-PURPOSE

Compatible with a wide range of work materials

SCM440H (32HRC)

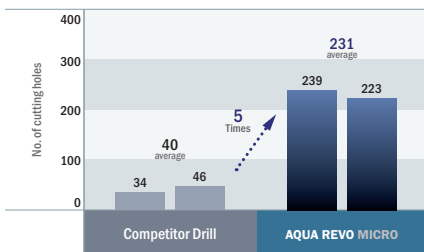

0.5
 Diameter
SCM440H (32HRC)
 Work Material
30m/min
 Cutting Speed
0.02mm/rev
 Feed Rate
5mm (10DC)
 Depth of Cutting: Blind hole
0.1mm (0.2DC)
 Step feed
 Cutting Fluid: Water-soluble
 M/C
 Machine: Vertical M/C

SKD61 (53HRC)

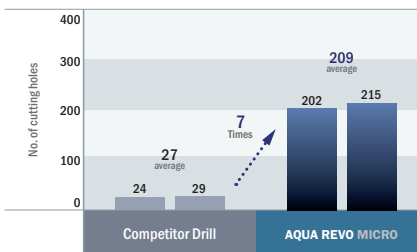

φ0.5
 Diameter
SKD61 (53HRC)
 Work Material
20m/min
 Cutting Speed
0.02mm/rev
 Feed Rate
5mm (10DC)
 Depth of Cutting: Blind hole
0.1mm (0.2DC)
 Step feed
 Cutting Fluid: Water-soluble
 M/C
 Machine: Vertical M/C

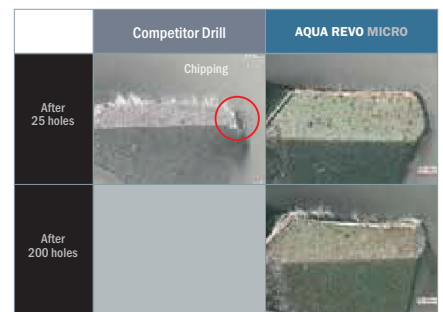

Applicable work Materials

Work Material	Structural Steel	Carbon Steel	Alloy Steel Heat treated Steel	Mold Steel Pre-Hardened Steel	Hardened Steel		Cast Iron	Stainless Steel			Aluminum Alloy
	SS400	S45C S50C	SCM Scr	30~40HRC	40~50HRC	50~55HRC	FC FCD	SUS304 SUS316	SUS420	SUS630	AC ADC
AQRVDM	◎	◎	◎	◎	◎	○	○	◎	◎	◎	○

◎: Excellent ○: Good

AQUA DRILL EX FLAT

- One Drill does it all – Eliminates the need to use a “center drill” or “end mill” on inclined or curved surfaces
- True 180° flat cutting edges creates minimal exit burr in Tubing & Thin Plates
- Double Margin for stable and precision Drilling



ELIMINATE END MILL DISH ANGLE

180° TRUE FLAT FACE

One cut to produce accurate counter bore surface

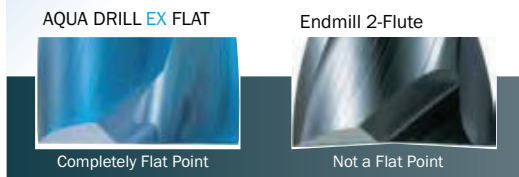

IMPROVED HEAT & WEAR RESISTANCE

AQUA EX COATING

TiAlN + AlCrTi Nano Layer Coating

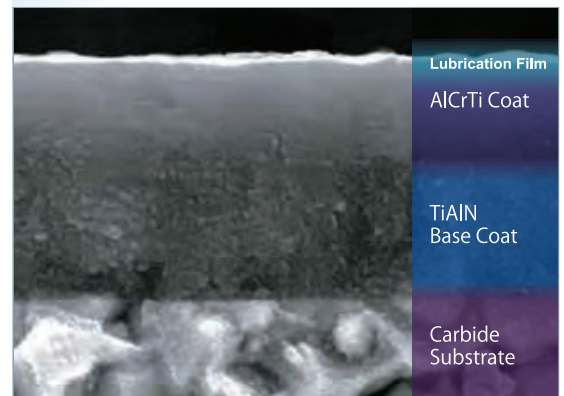

DURABLE AND STABLE DESIGN

AQUA DRILL EX OH FLAT

Features on 3D & 5D:

- 1) Double Margin
- 2) Corner Chamfer
- 3) Added Stability & Tool Life

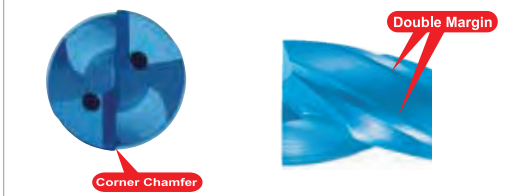

AQUA DRILL EX FLAT

Unique and Versatile High Performance Carbide Drill

One Step Drilling with Minimal Burr

Eliminate the need for “Center Drill” & “End mill”

● Not recommended for milling ❌

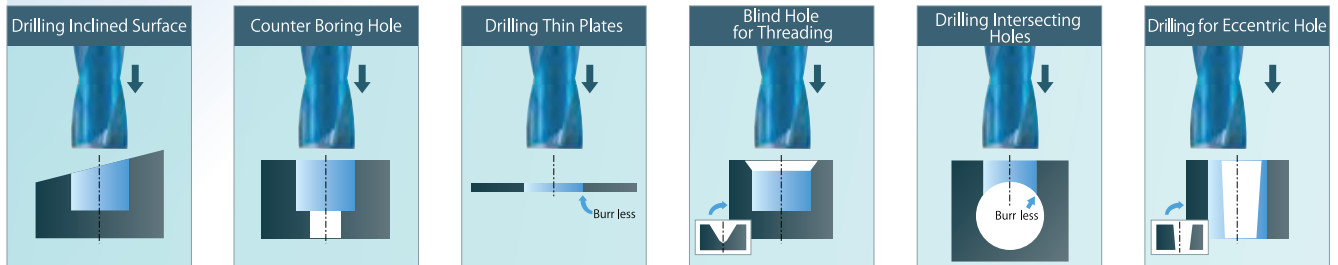

SS400 Wear after 105m (4100")

L9610, L9611
Non-Coolant Thru Stub Length Drill

L9628
Non-Coolant Thru Super Stub Length Drill

L9818, L9819
Non-Coolant Thru Jobber Length Drill

L9816, L9817
Extended Length up to 10D Reach

L9812, L9813
Coolant Thru 3D Flat Drill

L9814, L9815
Coolant Thru 5D Flat Drill

L9830, L9831
Ex Flat with Radius

Diameter ϕ 1 ϕ 2 ϕ 3 ϕ 6 ϕ 10 ϕ 16 ϕ 20

List No.	Diameter	
	Metric	Fractional
L9610 L9611	0.2 - 20.0	1/8 - 3/4
L9628	2.0 - 20.0	
L9818 L9819	3.0 - 20.0	1/8 - 3/4
L9816 L9817	3.0 - 20.0	1/8 - 3/4
L9812 L9813	1.0 - 16.0	1/8 - 3/4
L9814 L9815	1.0 - 16.0	1/8 - 5/8
L9830 L9831	3.0 - 12.0	1/8 - 3/4

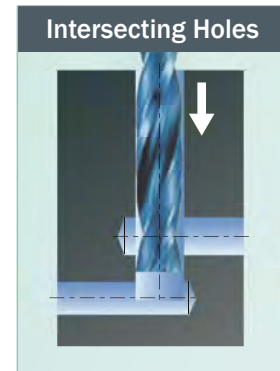
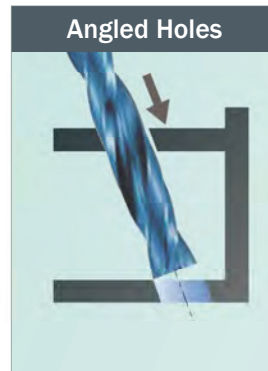
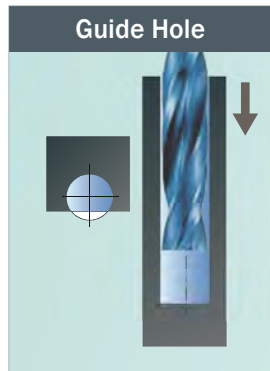
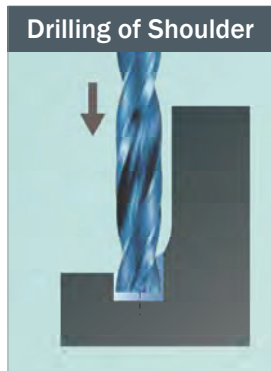

Applicable Work Materials

Work Material	Structural Steels	Carbon Steels	Pre-Hardened Steels Alloy Steels	Hardened Steels Mold Steels	Hardened Steels		Stainless Steels		Titanium Alloys	Cast Irons	Aluminum Alloys	Copper Alloys
	SS400	S45C	SCM/NAK	30~40HRC	40~50HRC	50~60HRC	SUS304/SUS316	SUS420	Nickel Alloys	FC/FCD	AC/ADC	CU
AQDEXZ AQDEXZR AQDEXZLS	○	○	○	○	●			○		○	●	●
AQDEXZOH3D AQDEXZOH5D	○	○	○	○	●		●	○	●	○	○	○

○: Great ●: Good

Designed for consistent high performance drilling
in stainless steels to high temperature alloys.

AQUA EX SERIES

AQUA DRILL EX CARBIDE DRILL SERIES

AQDEX0H10D, 15D, 20D, 25D, 30D, 40D, PLT



DRILLS

Features of Aqua EX Drill Series Fluting

- ▶ Unique J-shape flute design helps to generate easy chip break up.
- ▶ Smooth flute polishing facilitates fluid chip evacuation.
- ▶ Deep pockets ensure minimal chip packing.

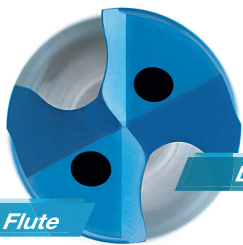

Smooth Flute

Deep Pocket

Features of Aqua EX Drill Series Coating

- ▶ Aqua EX coating is designed for superior performance in both dry and wet conditions.
- ▶ EX = Exotic materials, extreme conditions.
- ▶ Engineering to withstand heavy wear and maintain consistent performance.

True Blue

AQUA EX coating

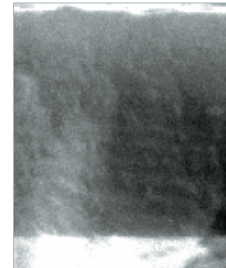

Anti-Adhesive Coating film

TiAlCr type multi-layered film

Tungsten Carbide

Long Tool Life

Cutting resistance is low

Flowing curve

Durability comparison

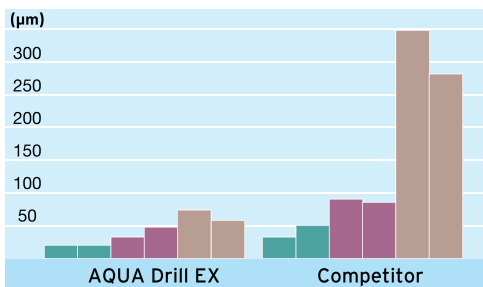

Durability comparison (Service Life)

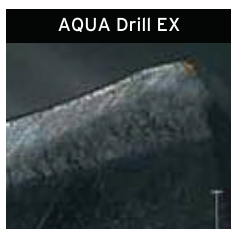
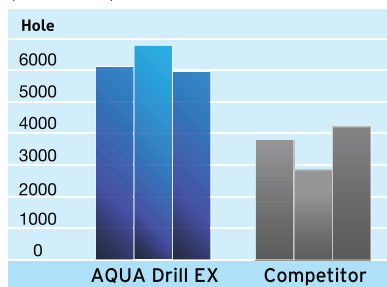

AQUA Drill EX

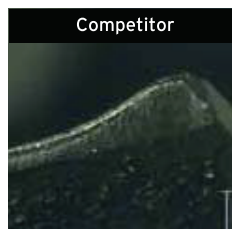

Competitor

Cutting Conditions

Tool	: AQDEXR6.0 (L9602)
Speed	: 100m/min (RPM=5300)
Feed	: 0.18mm/rev (960mm/min)
Feed	: 0.007 IPR / 21.0 IPM
Work Material	: C50 (Carbon Steel)
Cutting Fluid	: Water Soluble

Fine Chips with AQUA DRILL EX



Features

- Oil-Hole Drills for high efficiency drilling of small diameter deep holes
- Stable drilling of small diameter holes with new cutting edge geometry and large oil holes for efficient chip evacuation
- Suitable for wide work materials like Carbon Steels, Alloy Steels and Stainless Steels
- Multi-layered Aqua Ex Coating (TiALN+TiAlCr) plus anti-adhesive coating film for added lubrication

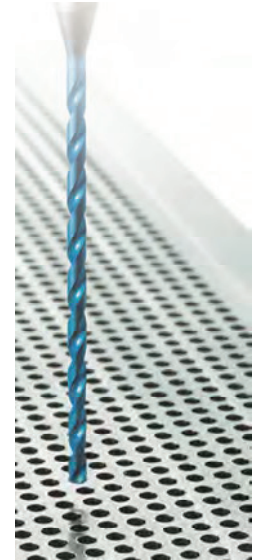

Performance



- New Oil Hole Design delivers coolant directly to the cutting edges
- New Cutting-Edge geometry breaks chips effectively
- Extremely smooth Aqua EX coating evacuates chips smoothly



Smooth Drill Flute Surface

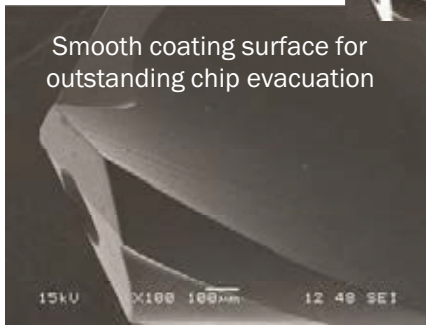

Stable Drilling of Deep Holes

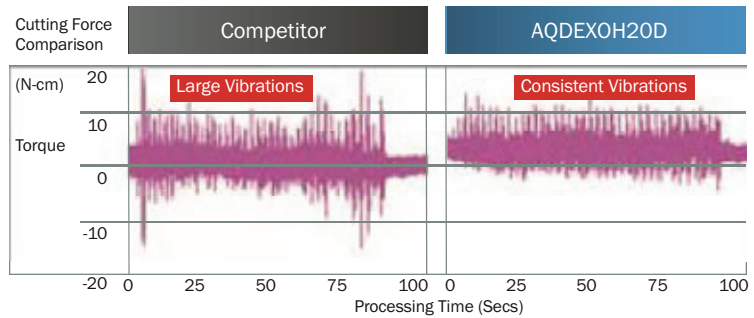

Cutting Condition

Tool Ø	Ø1.8	Coolant Type	Water Soluble - Coolant Thru
Cutting Speed	150 SFM (45m/min)	Hole Depth	38.1 mm (1.5") (20D) Blind Hole
Feed	0.003 IPR (310mm/min)	Step Feed Interval	0.17" (0.45 mm) / 0.25D
Work Material	Carbon Steel (S50C)	Guide Hole	AQDEXOHLT01815 for 1.8 mm Hole

Long Tool Life

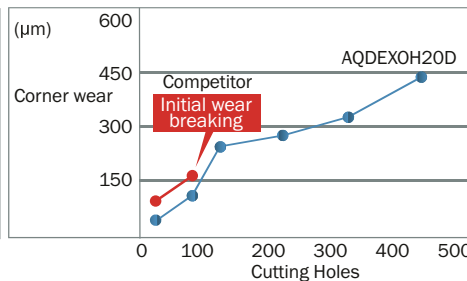
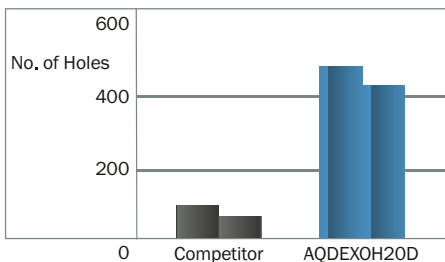

Cutting Condition

Tool Ø	Ø2.0
Cutting Speed	150 SFM (45m/min)
Feed/Speed	0.003 IPR (310mm/min)
Hole Depth	38.1 mm (1.5") (20D) Blind Hole
Step Feed Interval	0.17" (0.45 mm) / 0.25D
Coolant Type	Water Soluble - Coolant Thru
Guide Hole	AQDEXOHLT02015 for 2.0 mm Hole

Features

- High Precision drilling as deep as 5xD of drill.
- High accuracy achieved at high feed rate with optimized cutting edge form and superior drilling balance of 3-flutes.
- Multi-layered Aqua EX Coating (TiAlN + TiAlCr)
- Anti-adhesive coating film for added lubrication



Performance

Hole Enlargement



Comparison of Cutting Force

Cutting force is small, and controls amount of oversize.

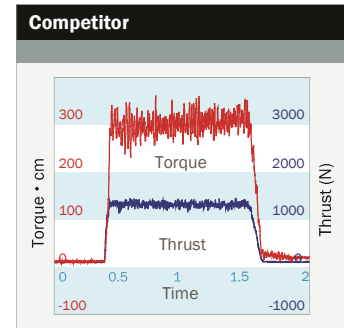
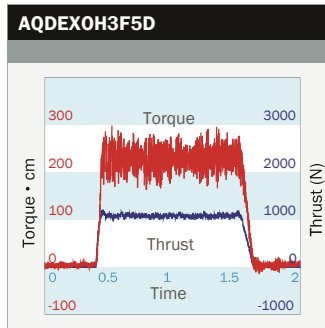

SS400 Wear After 105m (4100")

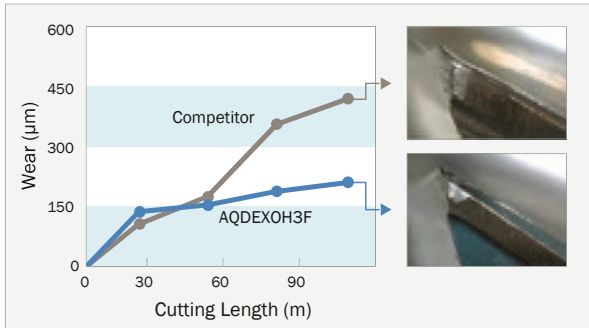

Cutting Condition

Tools Ø	Ø6	Carbon Steel (S50C)	Work Material
Speed	400 SFM (120m/min)	Water Soluble	Type of Coolant
Feed	59 IPM 1500mm/min (0.24mm/rev)	30mm - 1.2" (5D)	Depth/Blind Hole

SUS304 Wear After 60m (2360")



Cutting Condition

Tools Ø	Ø6	400 Stainless (SS400)	Work Material
Speed	328 SFM (100m/min)	Water Soluble	Type of Coolant
Feed	50 IPM 1280mm/min (0.24mm/rev)	30mm - 1.2" (5D)	Depth/Blind Hole

Cutting Condition

Tools Ø	Ø6	304 Stainless (SUS304)	Work Material
Speed	164 SFM (50m/min)	Water Soluble	Type of Coolant
Feed	18 IPM 480mm/min (0.18mm/rev)	30mm - 1.2" (5D)	Depth/Blind Hole

Applicable Work Materials

Structural Steels	Carbon Steels	Pre-Hardened Steels Alloy Steels	Hardened Steels Mold Steels	Hardened Steels		Stainless Steels		Titanium Alloys Nickel Alloys	Cast Irons	Aluminum Alloys	Copper Alloys
SS400	S45C/S50C	SCR/NAK	30~40HRC	40~50HRC	50~65HRC	SUS304/SUS316	SUS420		FCD/FC	AC/ADC	Cu
○	○	○	○	○	X	●	●	X	●	●	●

○ Great ● Good X Not Suitable

Performance

2-Flute Drill

Cutting Speed 150 SFM (45m/min)
 Feed Speed 0.010 IPR - 12 IPM (300mm/min)
 Roundness 14.5 μm

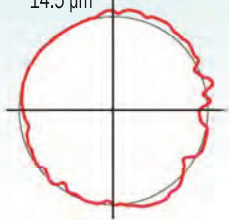

AQDEXOH3F

Cutting Speed 170 SFM (50m/min)
 Feed Speed 0.017 IPR - 22 IPM (570mm/min)
 Roundness 1.7 μm

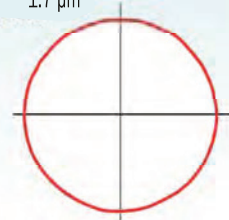

Cutting Condition

Tool Diameter Ø 12 mm
 Hole Depth/Blind Hole 36 mm (1.4")
 Work Material SUS304
 Cutting Fluid Water Soluble



Superior Hole Finish

Streamline Process & Reduce Cycle Time

Usual Process

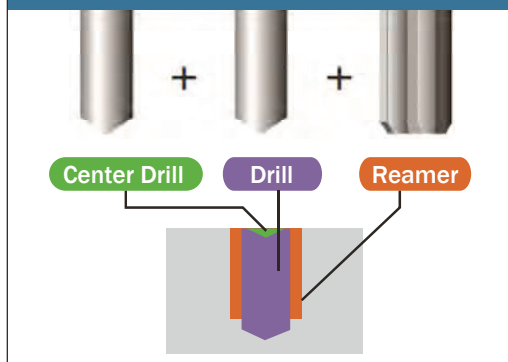

AQDEX OH3F

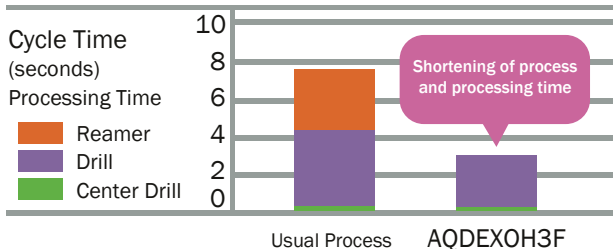
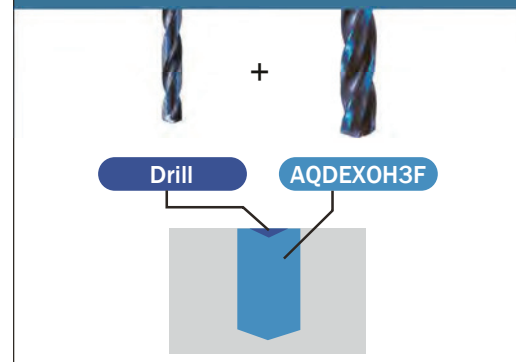

Cutting Condition

Diameter of Hole Ø12 H7
 Hole Depth 20 mm
 Work Material Carbon Steel

Features

- Utilizes a high accuracy shape of lip relief (3 rake, 2 rake + x-thinning)
- Made from premium powder metal with Composite Multi-Layer SG Coating (TiCN)
- End mill style shanks for highly precise and accurate drilling

Work Materials

- Structural Steels
- Alloy Steels
- Cast Irons
- Carbon Steels
- Stainless Steels
- Aluminum Alloys

Performance

- Streamline the process and reduce machining time dramatically.
- Eliminate the center drill operation with our SG-ESS drills (Stub length)
- Stable positioning within 0.0006" (15µm)
- Faster feed & speed rates than regular HSS-Co drills
- Better cost performance than carbide drills



SG-ESS Drills (Stub Length) Self Centering Point:

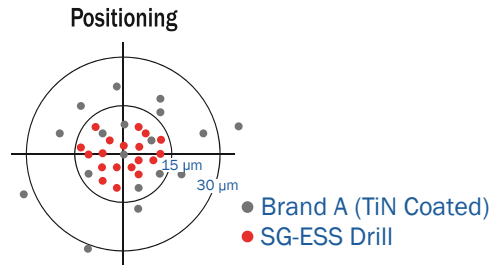
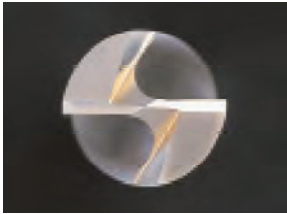

Characteristics of SG Coating

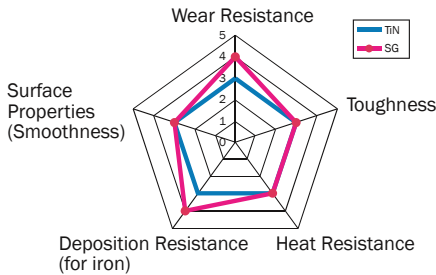

Composite multi-layer film coating method characterized by improved wear resistance as compared to TiN.

Benefits of Powdered Metal HSS

- Fine grain structure that distributes the heat more evenly
- Increased wear resistance
- Can be pushed harder than conventional HSS tools

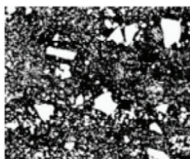

Conventional HSS

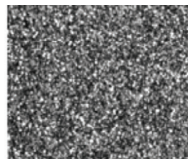

Powdered Metal HSS

Performance and Cutting Data of SG Drill Series

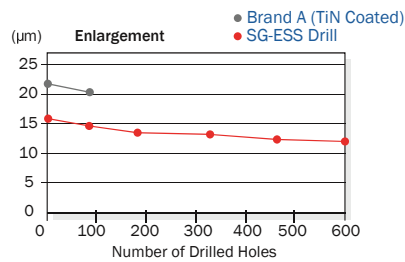

Cutting Condition

Drill Dia	9.0mm.
Hole Depth	32mm
Cutting Speed	20m/min. (65.6 SFM)
Feed	142mm/min (5.6 IPM)
Work Piece Material	Alloy steel (300HB)
Machine	Vertical machining center

Features

- Premium PM-Cobalt Substrate with composite SG Coating (Tin+Ticn)
- Equals Solid Carbide Drill in performance due to tough PM Cobalt Substrate

Work Materials

- Structural Steels
- Alloy Steels
- Cast Irons
- Carbon Steels
- Stainless Steels
- Aluminum Alloys

Performance

- 30 - 40% more tool life than conventional HSS/HSCO micro drills.
- Self centering point design with excellent positional accuracy.
- Precision ground end mill style shank for accurate and precision drilling.



DRILLS

Drilling Performance of SG-ESS Micro Drill

Diameter	Carbon Steel	304 Stainless Steel
0.5 mm		
	<p>SFM (RPM) 80 (15,500) Feed 0.0006 ipr / 9.3 ipm Hole Depth 1.5mm (Blind Hole) Cutting Fluid Water soluble</p>	<p>SFM (RPM) 26 (5000) Feed 0.0004 ipr / 2.0 ipm Hole Depth 1.5mm (Blind Hole) Cutting Fluid Water Soluble</p>
0.99 mm		
	<p>SFM (RPM) 80 (8,000) Feed 0.0015 ipr / 12 ipm Hole Depth 1.5mm (Blind Hole) Cutting Fluid Water Soluble</p>	<p>SFM (RPM) 30 (3,200) Feed 0.001 ipr / 2.5 ipm Hole Depth 3mm (Blind Hole) Cutting Fluid Water Soluble</p>

Applicable Work Materials

Drill Name	Structural Steels	Carbon Steels	Alloy Steels Pre-hardened Steels	Hardened Steels Mold Steels	Hardened Steels		Stainless Steels		Titanium Alloys Nickel Alloys	Cast Irons	Aluminum Alloys	Copper Alloys
	SS400	S45C/S50C	SCR/NAK	30~40HRC	40~50HRC	50~65HRC	304SS/316SS	400-Series		FCD/FC	AC/ADC	Cu
SGESS Drill	○	○	○	○	X	X	○	○	●	○	○	○

○: Great ●: Good X: Not Suitable

Features

- 4-Facet self-centering point
- Designed & Engineered for drilling Stainless Steel & Hi-Temp Alloys
- Made from Premium powdered metal cobalt substrate
- Composite Multi-layer SG Coating (Tin+TiCN)
- Precision ground end mill style shank for accurate and precision drilling.

Work Materials

- Hi-temp Alloys
- Stainless Steels
- Alloy Steels
- Aluminum Alloys
- Carbon Steels
- Cast Irons
- Structural Steels
- Brass & Bronze

Performance

- Equals Solid Carbide drill in performance in Stainless, Inconel & Titanium.
- 30 ~ 40% Cheaper than Carbide Drills
- Self-centering point eliminates need for center drill operations.



SG Coating (Tin+TiCN)

Well Suited for Drilling:

Tool Life in Carbon Steel

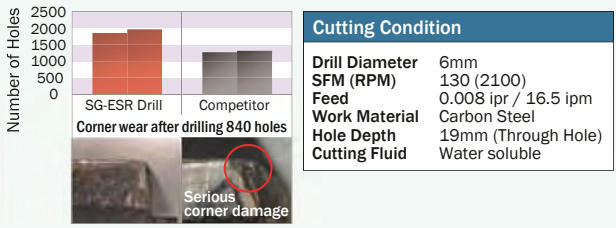

Tool Life in Alloy Steel

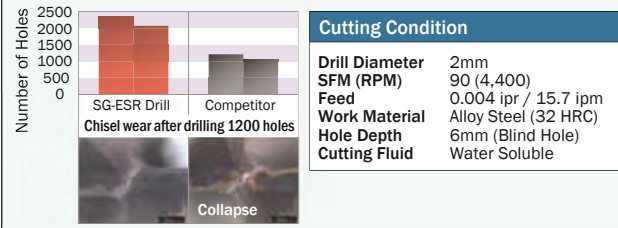

Tool Life in 400-Series Stainless

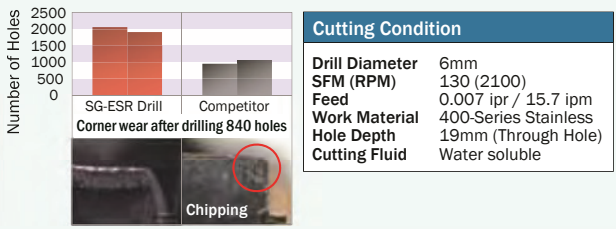

Tool Life in 304 Stainless Steel

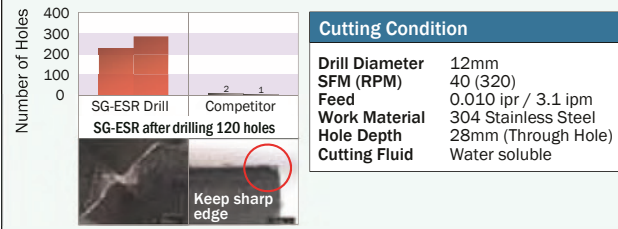

Applicable Work Materials

Drill Name	Structural Steels	Carbon Steels	Alloy Steels Pre-hardened Steels	Hardened Steels Mold Steels	Hardened Steels		Stainless Steels		Titanium Alloys Nickel Alloys	Cast Irons	Aluminum Alloys	Copper Alloys
	SS400	S45C/S50C	SCR/NAK	30~40HRC	40~50HRC	50~65HRC	304SS/316SS	400-Series		FCD/FC	AC/ADC	Cu
SGESR Drill	○	○	○	●	X	X	○	○	●	○	○	○

○: Great ●: Good X: Not Suitable

Features

New Style Parabolic Drills

- Flute geometry and coating enables non pecking deep hole drilling up to 20XD.
- AG Coating (TiAlN) and HSS-Co material increases tool life.

Work Materials

- Carbon Steels
- Alloy Steels
- Mold Steels
- Hardened Steels (under 40HRC)
- Cast Irons

Performance

AG Power Long Drill vs. Standard Drill



Stable Torque

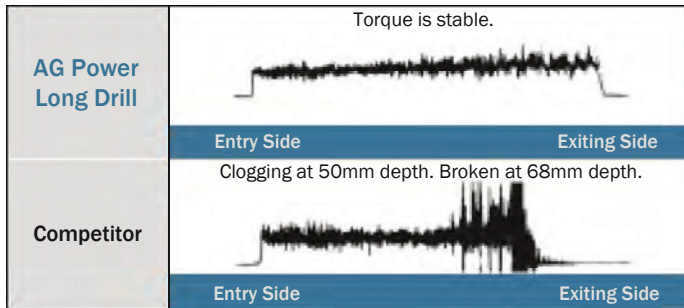

Cutting Condition

Drill Dia.	6 mm (0.236in)
Material	1050 (217HB) S50C
Hole Depth	102 mm (4.01in : 17D) through
Speed	1590 rpm (98 SFM)
Feed	0.1mm/rev (6.26 IPM)
Pecking	non
Coolant	Emulsion

Long Tool Life

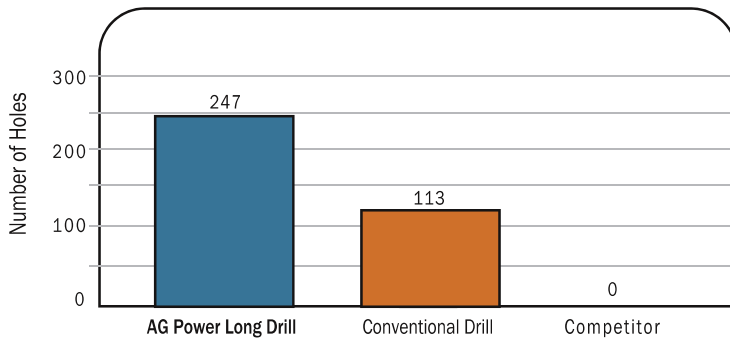

Features

- Utilizes high accuracy shape of lip relief (2 rake thinning)
- Utilizes flute geometry resulting in excellent chip control and dry milling with no edge build-up
- End mill style shanks for highly precise and accurate drilling

Work Materials

- Aluminums
- Aluminum Alloy Casting
- Copper Alloys
- Aluminum Alloys
- Aluminum Alloy Die-Casting

Performance

Wet Drilling By DLC Drill

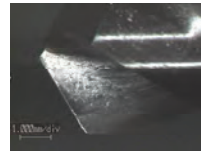
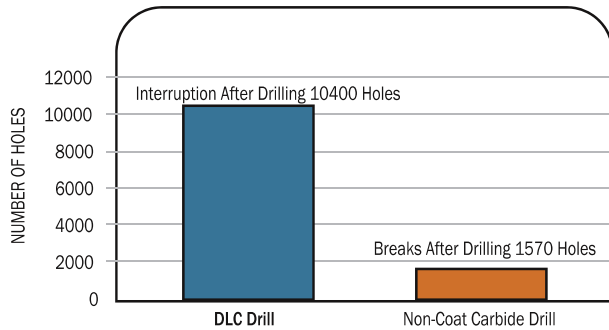

Small wear after drilling 10400 holes



Cutting Condition

Drill Dia.	5.5 mm (0.2165 in)
Material	AlMg2.5 (A5052)
Hole Depth	27.5 mm (1.06 in) blind
Speed	100m/min (328 SFM)
Feed	0.08mm/rev (18.26 IPM)
Coolant	Emulsion

Dry Drilling By DLC Drill

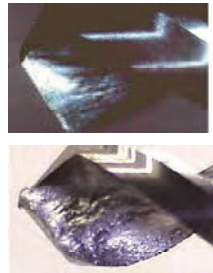
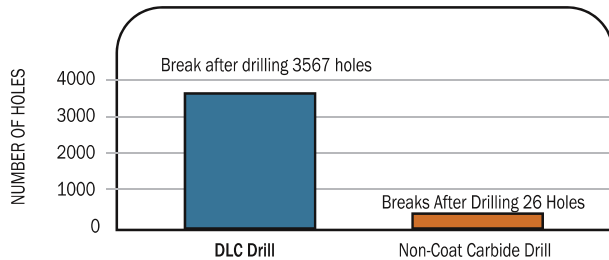

Cutting Condition

Drill Dia.	5.5 mm (0.2165 in)
Material	ADC12
Hole Depth	16.5 mm (0.65 in) blind
Speed	100m/min (328 SFM)
Feed	0.08mm/rev (18.26 IPM)
Coolant	Dry

Reading Your Drill Chips

When drilling, your chips will tell you a story. It is a common thought that running a drill at a slower feed or speed is “safer”, but that is not always the case. Sometimes, it can even be worse than running the drill too fast.



Chip shape will tell you a lot. The ideal shape for a chip can be described as “6’s and 9’s”. This means that the chip is short, like the tail of a 6, but curls up. Above there is an example of chips from some carbon steel. These pictures show that a slow speed did not help with tool life, but actually created improper chips that led to a decrease in tool life and poor quality hole. To the right, there is an example of how too slow a feed can cause the chisel of the drill to walk, creating an imperfect hole.



NEW!
Micro sizes
now available
in 25D, 30D
and 40D





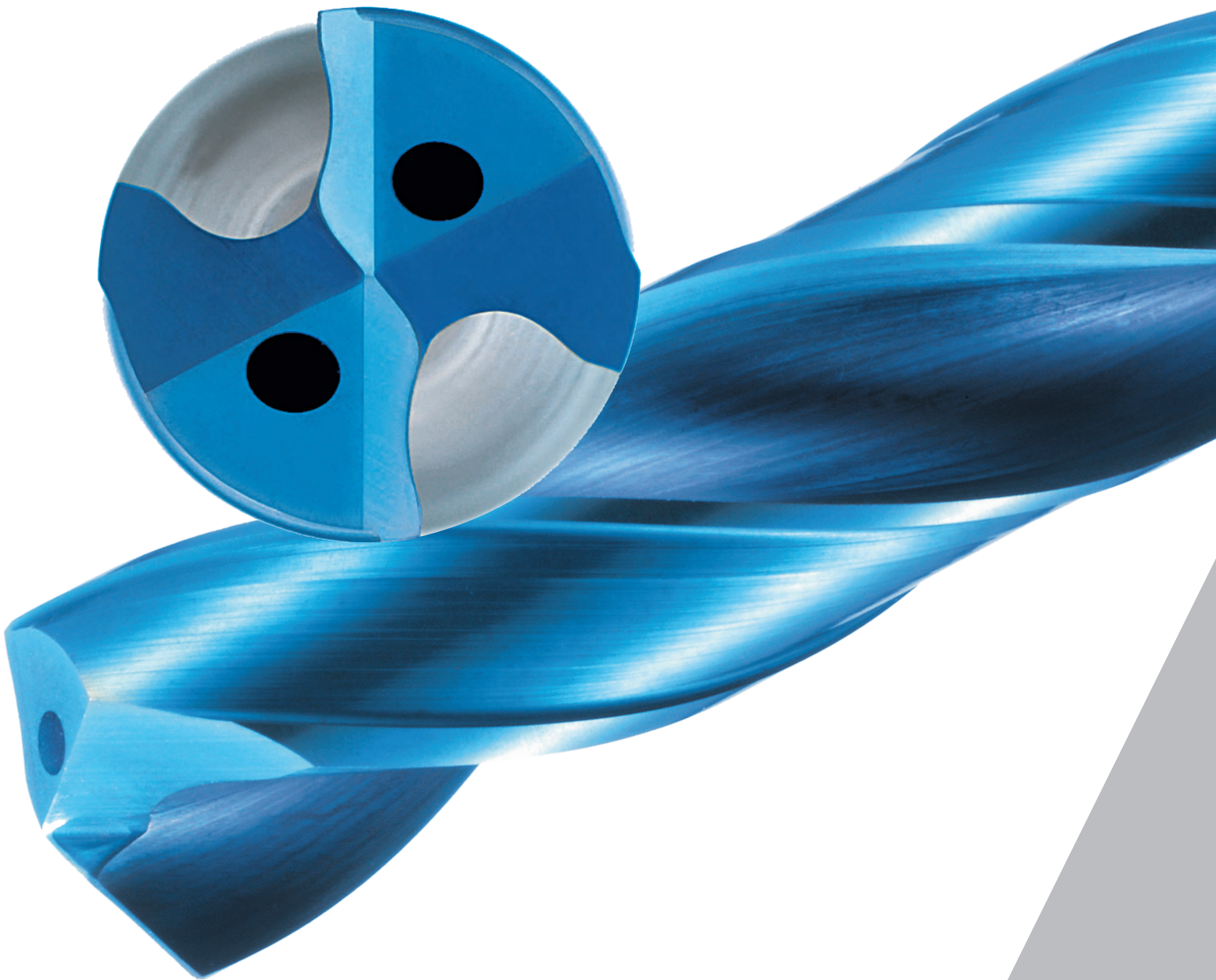













AQUA DRILL EX **CARBIDE DRILL SERIES**

Deep Hole 10D, 15D, 20D, 25D, 30D, 40D
Aqua EX Oil Hole Pilot



HIGH PERFORMANCE DRILLS

CARBIDE DRILLS

List No.	Drill Name	Material	Coating	Stock Size	Product Page		
Aqua REVO Drill							
9860		Carbide	REVO-D	Metric	2.0 to 16.0	p. 58-59	
9861				Fractional	1/8 to 5/8		
9862				Metric	2.0 to 16.0	p. 60-61	
9863				Fractional	1/8 to 5/8		
Aqua REVO Drill Oil Hole							
9864		Carbide	REVO-D	Metric	3.0 to 16.0	p. 64-65	
9866				Metric	3.0 to 16.0	p. 68-69	
9872				Metric	3.0 to 16.0	p. 62-63	
9873				Fractional	1/8 to 5/8		
9874				Metric	3.0 to 16.0	p. 66-67	
9875				Fractional	1/8 to 5/8		
9868				Metric	3.0 to 16.0	p. 70-71	
9869				Fractional	1/8 to 5/8		
Aqua Drill EX Oil Hole							
9604				Carbide	Aqua EX	Metric	1.0 to 2.9
9606		Metric	1.0 to 2.9			p. 93	
9612		Metric	1.0 to 12.0			p. 72	
9614		Metric	1.0 to 12.0			p. 73	
9615		Fractional	1/8 to 9/16				
9616		Metric	1.0 to 10.0			p. 74	
9617		Fractional	1/8 to 25/64				
9618		Metric	1.0 to 8.0			p. 76	
9619		Fractional	1/8 to 3/8				
9620		Metric	1.0 to 8.0			p. 77	
9621		Fractional	1/8 to 5/16				
9626		Metric	1.0 to 7.0			p. 79	
9627		Fractional	1/8 to 5/16				
9622		Metric	1.015 to 12.03			p. 81-82	
9623		Fractional	1/8 to 9/16				
Aqua Drill Micro							
9544		Carbide	Aqua	Metric	0.2 to 1.99	p. 90-91	
Aqua REVO Drill Micro							
9878		Carbide	REVO-D	Metric	0.5 to 1.99	p. 86-87	
9880				Metric	0.5 to 1.99	p. 88-89	















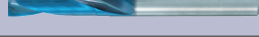







● : Great ○ : Good Δ : OK - : Not Recommended

List No.	Cutting Condition Page	Workpiece Material																
		Carbon Steel		Alloy Steel	Mold Steel	Hardened Steel			Stainless Steel		PH Stainless	Titanium Alloys	Nickel Alloys	Cast Iron		Aluminum		Copper Alloys
		Low Carbon	High Carbon			20 ~ 30	30 ~ 40	40 ~ 50	50 ~ 55	55 ~ 65				Austenitic 300 Series	Martensitic 400 Series	Soft <200HB	Hard >200HB	
9860	p. 59	●	●	●	●	●	○	-	Δ	○	○	○	○	●	●	○	○	○
9862	p. 61	●	●	●	●	●	○	-	Δ	○	○	○	○	●	●	○	○	○
9863		●	●	●	●	●	○	-	Δ	○	○	○	○	●	●	○	○	○
9864	p. 65	●	●	●	●	●	○	-	●	●	●	○	○	●	●	○	○	○
9866	p. 69	●	●	●	●	●	○	-	●	●	●	○	○	●	●	○	○	○
9872	p. 63	●	●	●	●	●	○	-	●	●	●	○	○	●	●	○	○	○
9873		●	●	●	●	●	○	-	●	●	●	○	○	●	●	○	○	○
9874	p. 67	●	●	●	●	●	○	-	●	●	●	○	○	●	●	○	○	○
9875		●	●	●	●	●	○	-	●	●	●	○	○	●	●	○	○	○
9868	p. 71	●	●	●	●	●	○	-	●	●	●	○	○	●	●	○	○	○
9869		●	●	●	●	●	○	-	●	●	●	○	○	●	●	○	○	○
9604	p. 93	●	●	●	●	-	-	-	●	●	●	●	●	○	○	○	○	○
9606	p. 93	●	●	●	●	-	-	-	●	●	●	●	●	○	○	○	○	○
9612	p. 75	●	●	●	●	○	-	-	●	●	●	○	○	●	●	○	○	○
9614	p. 75	●	●	●	●	○	-	-	●	●	●	○	○	●	●	○	○	○
9615		●	●	●	●	○	-	-	●	●	●	○	○	●	●	○	○	○
9616	p. 75	●	●	●	●	○	-	-	●	●	●	○	○	●	●	○	○	○
9617		●	●	●	●	○	-	-	●	●	●	○	○	●	●	○	○	○
9618	p. 78	●	●	●	●	○	-	-	●	●	●	○	○	●	●	○	○	○
9619		●	●	●	●	○	-	-	●	●	●	○	○	●	●	○	○	○
9620	p. 78	●	●	●	●	○	-	-	●	●	●	○	○	●	●	○	○	○
9621		●	●	●	●	○	-	-	●	●	●	○	○	●	●	○	○	○
9626	p. 80	●	●	●	●	○	-	-	●	●	●	○	○	●	●	○	○	○
9627		●	●	●	●	○	-	-	●	●	●	○	○	●	●	○	○	○
9622	p. 82	●	●	●	●	○	-	-	●	●	●	○	○	●	●	○	○	○
9623		●	●	●	●	○	-	-	●	●	●	○	○	●	●	○	○	○
9544	p. 92	●	●	●	●	●	-	-	●	●	●	○	○	○	○	○	○	○
9878	p. 87	●	●	●	●	●	○	-	●	●	●	○	○	○	○	○	○	○
9880	p. 89	●	●	●	●	●	○	-	●	●	●	○	○	○	○	○	○	○

CARBIDE DRILLS

HIGH PERFORMANCE DRILLS

CARBIDE DRILLS

List No.	Drill Name	Material	Coating	Stock Size	Product Page		
Aqua Drill EX Oil Hole 3 Flute							
9826		Carbide	Aqua EX	Metric	3.0 to 16.0	p. 83	
9820				Fractional	3.0 to 16.0	p. 84	
Aqua Drill EX Flat							
9628		Carbide	Aqua EX	Metric	2.0 to 20.0	p. 81-82	
9610				Fractional	0.2 to 20.0		p. 96-97
9611				Fractional	1/8 to 3/4	p. 98	
9830				Metric	3.0 to 12.0		p. 100
9831				Fractional	1/8 to 3/4	p. 101	
9818				Metric	3.0 to 20.0		p. 101
9819				Fractional	1/8 to 3/4	p. 101	
9816				Metric	3.0 to 20.0		p. 101
9817		Fractional	1/8 to 3/4				
Aqua Drill EX Flat Oil Hole							
9812		Carbide	Aqua EX	Metric	1.0 to 16.0	p. 103-104	
9813				Fractional	1/8 to 3/4		p. 105-106
9814		Carbide	Aqua EX	Metric	1.0 to 16.0	p. 105-106	
9815				Fractional	1/8 to 5/8		
Aqua Drill EX Starter							
9624		Carbide	Aqua EX	Metric	3.0 to 20.0	p. 109	
AG Drill							
6502		HSS-Co	AG	Metric	3.0 to 20.0	p. 110	
6504				Metric	3.0 to 20.0	p. 110	
6540P				Ser. 1	Metric	1.0 to 13.0	p. 121
				Fractional	1/8 to 3/8		
6541P				Ser. 2	Metric	1.0 to 10.0	
	Fractional	1/8 to 3/8					
	Ser. 3	Metric	3.0 to 10.0				
	Fractional	1/8 to 5/16					
SG Drill							
7572P		PM-HSS	SG	Metric	0.5 to 20.0	p. 111-116	
7573P				Fractional	3/64 to 3/4		p. 117-118
	Letter			B to Z			
	Wire			#1 to #76			
7574P				Metric	2.0 to 32.0	p. 117-118	
7575P		Fractional	3/32 to 3/4				
		Letter	B to Z				
	Wire	#1 to #45					
7596P		Metric	3.0 to 12.0	p. 120			
7591P		Fractional	1/8 to 3/4				











● : Great ○ : Good △ : OK - : Not Recommended

List No.	Cutting Condition Page	Workpiece Material																
		Carbon Steel		Alloy Steel	Mold Steel	Hardened Steel			Stainless Steel		PH Stainless	Titanium Alloys	Nickel Alloys	Cast Iron		Aluminum		Copper Alloys
		Low Carbon	High Carbon			HRc			Austenitic 300 Series	Martensitic 400 Series				Soft <200HB	Hard >200HB	6061 7075	Cast	
				20 ~ 30	30 ~ 40	40 ~ 50	50 ~ 55	55 ~ 65										
Aqua Drill EX Oil Hole 3 Flute																		
9826	p. 84	●	●	●	●	●	-	-	●	●	●	-	○	●	●	-	○	-
9820	p. 84	●	●	●	●	●	-	-	●	●	●	-	○	●	●	-	○	-
Aqua Drill EX Flat																		
9628	p. 82	●	●	●	●	○	-	-	●	●	○	○	○	●	●	○	○	○
9610	p. 99	●	●	●	●	○	-	-	●	●	○	○	○	●	●	○	○	○
9611		●	●	●	●	○	-	-	●	●	○	○	○	●	●	○	○	○
9830	p. 99	●	●	●	●	○	-	-	○	●	○	○	○	●	●	○	○	○
9831		●	●	●	●	○	-	-	○	●	○	○	○	●	●	○	○	○
9818	p. 102	●	●	●	●	○	-	-	○	●	○	-	○	●	●	○	○	○
9819		●	●	●	●	○	-	-	○	●	○	-	○	●	●	○	○	○
9816	p. 102	●	●	●	●	○	-	-	○	●	○	-	○	●	●	○	○	○
9817		●	●	●	●	○	-	-	○	●	○	-	○	●	●	○	○	○
Aqua Drill EX Flat Oil Hole																		
9812	p. 104	●	●	●	●	○	-	-	●	●	●	-	○	●	●	●	●	●
9813		●	●	●	●	○	-	-	●	●	●	-	○	●	●	●	●	●
9814	p. 106	●	●	●	●	○	-	-	●	●	●	-	○	●	●	●	●	●
9815		●	●	●	●	○	-	-	●	●	●	-	○	●	●	●	●	●
Aqua Drill EX Starter																		
9624	p. 109	●	●	●	●	○	-	-	●	●	●	○	○	●	●	○	○	○
AG Drill																		
6502	p. 109	●	●	●	●	-	-	-	○	○	○	○	○	○	○	○	○	○
6504	p. 109	●	●	●	●	-	-	-	○	○	○	○	○	○	○	○	○	○
6540P	p. 122	●	●	●	●	-	-	-	-	-	-	-	-	●	●	-	-	-
6541P		●	●	●	●	-	-	-	-	-	-	-	-	●	●	-	-	-
SG Drill																		
7572P	p. 116	●	●	●	●	-	-	-	●	●	●	●	○	●	●	○	○	○
7573P		●	●	●	●	-	-	-	●	●	●	●	○	●	●	○	○	○
7574P	p. 119	●	●	●	○	-	-	-	●	●	●	○	-	●	●	○	○	○
7575P		●	●	●	○	-	-	-	●	●	●	○	-	●	●	○	○	○
7596P	p. 120	●	●	●	●	-	-	-	○	○	○	○	○	○	○	○	○	○
7591P		●	●	●	●	-	-	-	○	○	○	○	○	○	○	○	○	○

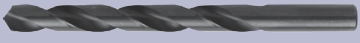
CARBIDE DRILLS

STRAIGHT SHANK DRILLS

CARBIDE DRILLS

List No.	Drill Name	Material	Coating	Stock Size	Product Page	
Screw Machine Length						
561		Bright	HSS	Bright	Fractional 3/64 to 2 Wire #1 to #60 Letter A to Z	p. 123
561P		TiN Coated		TiN	Fractional 1/16 to 1/2 Wire #1 to #52	p. 126
563		Aircraft NAS 907-C	HSSCO	Black Oxide	Fractional 3/64 to 1/2 Wire #1 to #52 Letter A to Z	p. 127
6563		Aircraft NAS 907-C			Fractional 3/64 to 1/2 Wire #1 to #52 Letter A to Z	p. 128
Jobber Length						
501A		Bright	HSS	Bright	Fractional 1/64 to 11/16 Wire #1 to #80 Letter A to Z	p. 129
500		Standard			Metric 0.2 to 17.5	p. 130
501		Standard	HSSCO	Black Oxide	Fractional 3/64 to 11/16 Wire #1 to #60 Letter A to Z	p. 131
6501		Aircraft NAS 907-J			Fractional 1/64 to 1/2 Wire #1 to #80 Letter A to Z	p. 132
6520		Cobalt		Metric 0.5 to 13.0	p. 133	
520P		TiN Coated	HSS	TiN	Metric 0.5 to 13.0	p. 134
501P		TiN Coated			Fractional 1/16 to 1/2 Wire #1 to #52	p. 135
517P		Parabolic - TiN Coated			Fractional 1/16 to 1/2 Wire #1 to #52	p. 136













● : Great ○ : Good Δ : OK - : Not Recommended

List No.	Cutting Condition Page	Workpiece Material																		
		Carbon Steel		Alloy Steel	Mold Steel	Hardened Steel					Stainless Steel		PH Stainless	Titanium Alloys	Nickel Alloys	Cast Iron		Aluminum		Copper Alloys
		Low Carbon	High Carbon			HRc					Austenitic 300 Series	Martensitic 400 Series				<200HB	>200HB	6061 7075	Cast	
				20 ~ 30	30 ~ 40	40 ~ 50	50 ~ 55	55 ~ 65												
Screw Machine Length																				
561	p. 148	○	○	○	-	-	-	-	-	-	-	-	-	-	Δ	-	Δ	Δ	Δ	
561P	p. 148	●	●	●	Δ	-	-	-	Δ	Δ	Δ	Δ	Δ	Δ	○	Δ	Δ	Δ	Δ	
563	p. 148	○	○	○	-	-	-	-	-	-	-	-	-	-	Δ	Δ	Δ	Δ	Δ	
6563	p. 148	●	●	●	Δ	-	-	-	Δ	○	Δ	○	Δ	Δ	Δ	Δ	Δ	Δ	Δ	
Jobber Length																				
501A	p. 148	○	○	○	-	-	-	-	-	-	-	-	-	-	Δ	-	Δ	Δ	Δ	
500	p. 148	○	○	○	-	-	-	-	-	-	-	-	-	-	Δ	Δ	Δ	Δ	Δ	
501	p. 148	○	○	○	-	-	-	-	-	-	-	-	-	-	Δ	Δ	Δ	Δ	Δ	
501	p. 148	●	●	●	Δ	-	-	-	Δ	○	Δ	○	Δ	Δ	Δ	Δ	Δ	Δ	Δ	
6520	p. 148	●	●	●	Δ	-	-	-	Δ	○	Δ	○	Δ	Δ	Δ	Δ	Δ	Δ	Δ	
520P	p. 148	●	●	●	Δ	-	-	-	Δ	Δ	Δ	Δ	Δ	○	Δ	Δ	Δ	Δ	Δ	
501P	p. 148	●	●	●	Δ	-	-	-	Δ	Δ	Δ	Δ	Δ	○	Δ	Δ	Δ	Δ	Δ	
517P	p. 149	●	●	●	Δ	-	-	-	Δ	Δ	Δ	Δ	Δ	○	Δ	Δ	Δ	Δ	Δ	

CARBIDE DRILLS

STRAIGHT SHANK DRILLS

CARBIDE DRILLS

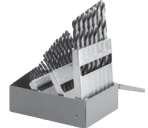
List No.	Drill Name	Material	Coating	Stock Size	Product Page		
Taper Length Drill							
531		Standard	HSS	Black Oxide	Fractional	1/64 to 1/2	p. 137
6531		Cobalt	HSCO		Fractional	1/16 to 3/4	p. 138
545P		Parabolic - TiN Coated	HSS	TiN	Fractional	1/16 to 1/2	p. 139
Extra Length Drill							
551		12" OAL	HSS	Bright	Fractional	1/8 to 1	p. 140
551		18" OAL			Fractional	1/8 to 1	p. 140
6551		10" OAL	HSCO	Black Oxide	Fractional	3/16 to 1/2	p. 141
Oil Hole Drill							
581		Standard	HSCO	Bright	Fractional	3/8 to 1-1/2	p. 142
Taper Shank Drill							
601		Regular	HSS	Black Oxide	Fractional	9/32 to 3-1/2	p. 143
651		Extra Length - 18"		Bright	Fractional	1/4 to 2	p. 144
651		Extra Length - 24"			Fractional	5/16 to 2-1/2	p. 144
683		Oil Hole	HSCO		Fractional	3/8 to 1-1/2	p. 145
Silver and Deming Drills							
575		1/2" Reduced Shank	HSS	Bright	Fractional	1/2 to 1-1/2	p. 146
HSS and HSCO Drill Sets							
599		Drill Sets	HSS, HSCO	Black Oxide, Bright	See Catalog Page For Size Information		p. 147

DRILLS / SELECTION CHART

● : Great ○ : Good Δ : OK - : Not Recommended

List No.	Cutting Condition Page	Workpiece Material																	
		Carbon Steel		Alloy Steel	Mold Steel	Hardened Steel				Stainless Steel		PH Stainless	Titanium Alloys	Nickel Alloys	Cast Iron		Aluminum		Copper Alloys
		Low Carbon	High Carbon			HRc				Austenitic 300 Series	Martensitic 400 Series				<200HB	>200HB	6061 7075	Cast	
				20 ~ 30	30 ~ 40	40 ~ 50	50 ~ 55	55 ~ 65											
531	p. 148	○	○	○	-	-	-	-	-	-	-	-	-	Δ	Δ	Δ	Δ	Δ	
6531	p. 148	●	●	●	○	-	-	-	Δ	○	Δ	○	Δ	Δ	Δ	Δ	Δ	Δ	
545P	p. 149	●	●	●	○	-	-	-	Δ	Δ	Δ	Δ	Δ	○	Δ	Δ	Δ	Δ	
551	p. 149	○	○	○	-	-	-	-	-	-	-	-	-	Δ	-	Δ	Δ	Δ	
551	p. 149	○	○	○	-	-	-	-	-	-	-	-	-	Δ	-	Δ	Δ	Δ	
6551	p. 149	●	●	●	Δ	-	-	-	Δ	○	Δ	○	Δ	Δ	Δ	Δ	Δ	Δ	
581	p. 150	●	●	●	●	-	-	-	Δ	○	○	○	Δ	Δ	Δ	Δ	Δ	Δ	
601	p. 150	●	●	●	○	○	-	-	●	●	●	-	○	●	●	●	●	●	
651	p. 150	●	●	●	○	○	-	-	●	●	●	○	○	●	●	○	○	○	
651	p. 150	●	●	●	○	-	-	-	○	○	○	○	○	○	○	○	○	○	
683	p. 150	●	●	●	●	-	-	-	-	-	-	-	-	●	●	-	-	-	
575	p. 150	●	●	●	-	-	-	-	-	-	-	-	-	○	-	○	○	○	
599	-	○	○	○	-	-	-	-	-	-	-	-	-	Δ	Δ	Δ	Δ	Δ	

CARBIDE DRILLS

HIGH PERFORMANCE DRILLS

AQUA REVO Drill Stub



Carbide REV D H7 135° 30° H6 2.0-16.0
Material Coating Dia. Tolerance Point Angle Helix Shank Dia. Tol. Size Range

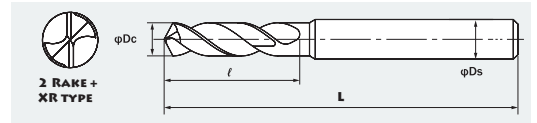

LIST 9860 Metric Sizes

LIST 9861 Wire, Fractional & Letter Sizes

Unit: mm

CARBIDE DRILLS

EDP#	Size	Decimal Equiv.	Wire, Fractional, Letter	Flute Length	Overall Length	Shank Diameter
	Dc			l	L	Ds
0769955	2.000	0.0787		9	45	3
0769978	2.100	0.0827		11		
0769990	2.200	0.0866				
0770010	2.300	0.0906				
1547745	2.381	0.0938	3/32			
0770033	2.400	0.0945				
0770056	2.500	0.0984				
0770079	2.600	0.1024				
0770091	2.700	0.1063				
1547751	2.778	0.1094	7/64			
0770113	2.800	0.1102		14		
0770136	2.900	0.1142				
0770159	3.000	0.1181				
0770171	3.100	0.1220				
1547768	3.175	0.1250	1/8			
0770194	3.200	0.1260				
0770216	3.300	0.1299				
0770239	3.400	0.1339				
0770251	3.500	0.1378				
1547774	3.572	0.1406	9/64			
0770274	3.600	0.1417		20		
0770297	3.700	0.1457				
0770319	3.800	0.1496				
0770331	3.900	0.1535				
1547780	3.969	0.1563	5/32			
0770354	4.000	0.1575				
1548094	4.039	0.1590	#21			
1548100	4.089	0.1610	#20			
0773783	4.100	0.1614				
0773790	4.200	0.1654				
0773805	4.300	0.1693		24		
1547797	4.366	0.1719	11/64			
0773811	4.400	0.1732				
0773828	4.500	0.1772				
0773834	4.600	0.1811				
0773840	4.700	0.1850				
1547802	4.762	0.1875	3/16			
0773857	4.800	0.1890				
0773863	4.900	0.1929				
0773870	5.000	0.1969				
0770572	5.100	0.2008		26		
1548116	5.105	0.2010	#7			
1547819	5.159	0.2031	13/64			
0770595	5.200	0.2047				
0770617	5.300	0.2087				
0770630	5.400	0.2126				
1548122	5.410	0.2130	#3			
0770652	5.500	0.2165				
1547825	5.556	0.2187	7/32			
0770675	5.600	0.2205				
1548139	5.613	0.2210	#2			
0770698	5.700	0.2244		28		
0770710	5.800	0.2283				
0770732	5.900	0.2323				
1547831	5.953	0.2344	15/64			
0770755	6.000	0.2362				

EDP#	Size	Decimal Equiv.	Wire, Fractional, Letter	Flute Length	Overall Length	Shank Diameter
	Dc			l	L	Ds
0773886	6.100	0.2402		32	74	8
0773892	6.200	0.2441				
0773908	6.300	0.2480				
1547848	6.350	0.2500	1/4			
0773914	6.400	0.2520				
0773920	6.500	0.2559				
1548185	6.528	0.2570	F			
0773937	6.600	0.2598				
0773943	6.700	0.2638				
1547854	6.747	0.2656	17/64			
0773950	6.800	0.2677		35		
0773966	6.900	0.2717				
1548151	6.909	0.2720	I			
0773972	7.000	0.2756				
1548168	7.036	0.2770	J			
0770864	7.100	0.2795				
1547860	7.144	0.2813	9/32			
0770870	7.200	0.2835				
0770887	7.300	0.2874				
0770893	7.400	0.2913				
0770909	7.500	0.2953		38		
1547877	7.541	0.2969	19/64			
0770915	7.600	0.2992				
0770921	7.700	0.3031				
0770938	7.800	0.3071				
0770944	7.900	0.3110				
1547883	7.937	0.3125	5/16			
0770950	8.000	0.3150				
0773989	8.100	0.3189				
0773995	8.200	0.3228				
1548174	8.204	0.3230	P			
0774000	8.300	0.3268				
1547890	8.334	0.3281	21/64			
0774016	8.400	0.3307				
1548180	8.433	0.3320	Q			
0774022	8.500	0.3346		40		
0774039	8.600	0.3386				
0774045	8.700	0.3425				
1547905	8.731	0.3437	11/32			
0774051	8.800	0.3465				
0774068	8.900	0.3504				
0774074	9.000	0.3543				
0771069	9.100	0.3583				
1547911	9.128	0.3594	23/64			
0771075	9.200	0.3622				
0771081	9.300	0.3661		43		
1548197	9.347	0.3680	U			
0771098	9.400	0.3701				
0771103	9.500	0.3740				
1547928	9.525	0.3750	3/8			
0771110	9.600	0.3780				
0771126	9.700	0.3819				
0771132	9.800	0.3858				
0771149	9.900	0.3898				
1547934	9.922	0.3906	25/64			
0771155	10.000	0.3937				

HIGH PERFORMANCE DRILLS

CARBIDE DRILLS

EDP#	Size	Decimal Equiv.	Wire, Fractional, Letter	Flute Length	Overall Length	Shank Diameter
	Dc			I	L	Ds
0774080	10.100	0.3976		43	95	12
0774097	10.200	0.4016				
0774102	10.300	0.4055				
1547940	10.319	0.4063	13/32			
0774119	10.400	0.4094				
0774125	10.500	0.4134				
0774131	10.600	0.4173		47	102	14
0774148	10.700	0.4213				
1547957	10.716	0.4219	27/64			
0774154	10.800	0.4252				
0774160	10.900	0.4291				
0774177	11.000	0.4331				
0771264	11.100	0.4370		50	102	14
1547963	11.112	0.4375	7/16			
0771270	11.200	0.4409				
0771287	11.300	0.4449				
0771293	11.400	0.4488				
0771309	11.500	0.4528				
1547970	11.509	0.4531	29/64	52	102	14
0771315	11.600	0.4567				
0771321	11.700	0.4606				
0771338	11.800	0.4646				
0771344	11.900	0.4685				
1547986	11.906	0.4687	15/32			
0771350	12.000	0.4724		50	102	14
0774183	12.100	0.4764				
0774190	12.200	0.4803				
0774205	12.300	0.4843				
1547992	12.303	0.4844	31/64			
0774211	12.400	0.4882				
0774228	12.500	0.4921		52	102	14
0774234	12.600	0.4961				
0774240	12.700	0.5000				
1548007	12.700	0.5000	1/2			
0774257	12.800	0.5039				
0774263	12.900	0.5079				
0774270	13.000	0.5118				

EDP#	Size	Decimal Equiv.	Wire, Fractional, Letter	Flute Length	Overall Length	Shank Diameter
	Dc			I	L	Ds
1548013	13.097	0.5156	33/64	53	107	14
0771460	13.100	0.5157				
0771476	13.200	0.5197				
0771482	13.300	0.5236				
0771499	13.400	0.5276				
1548020	13.494	0.5313	17/32			
0771504	13.500	0.5315		55	110	16
0771510	13.600	0.5354				
0771527	13.700	0.5394				
0771533	13.800	0.5433				
1548036	13.891	0.5469	35/64			
0771540	13.900	0.5472				
0771556	14.000	0.5512		56	114	16
0774286	14.100	0.5551				
0774292	14.200	0.5591				
1548042	14.287	0.5625	9/16			
0774308	14.300	0.5630				
0774314	14.400	0.5669				
0774320	14.500	0.5709		58	114	16
0774337	14.600	0.5748				
1548059	14.684	0.5781	37/64			
0774343	14.700	0.5787				
0774350	14.800	0.5827				
0774366	14.900	0.5866				
0774372	15.000	0.5906		58	114	16
1548065	15.081	0.5937	19/32			
0771665	15.100	0.5945				
0771671	15.200	0.5984				
0771688	15.300	0.6024				
0771694	15.400	0.6063				
1548071	15.478	0.6094	39/64	58	114	16
0771700	15.500	0.6102				
0771716	15.600	0.6142				
0771722	15.700	0.6181				
0771739	15.800	0.6220				
1548088	15.875	0.6250	5/8			
0771745	15.900	0.6260		58	114	16
0771751	16.000	0.6299				

LIST 9860, 9861 Standard Wet Cutting Conditions

Work Material		Structural Steel Carbon Steel Cast Iron		Alloy Steel Heat Treated Steel (20 - 30 HRC)		Mold Steel Hardened Steel (30 - 40 HRC)		Hardened Steel (40 - 50 HRC)		Ductile Cast Iron		Stainless Steel (300 Series)		Nickel Alloys Titanium Alloys PH Stainless		Aluminum Alloy	
Speed (SFM)		320 - 330 SFM		255 - 265 SFM		140 - 150 SFM		100 - 105 SFM		245 - 255 SFM		100 - 110 SFM		65-75 SFM		340 - 360 SFM	
Drill Diameter		RPM	Feed (IPR)	RPM	Feed (IPR)	RPM	Feed (IPR)	RPM	Feed (IPR)	RPM	Feed (IPR)	RPM	Feed (IPR)	RPM	Feed (IPR)	RPM	Feed (IPR)
Metric	Fractional																
2		16000	0.0023	12700	0.0023	7200	0.0017	4800	0.0014	11900	0.0023	5000	0.0009	4120	0.0010	16750	0.0022
3		10600	0.0035	8500	0.0033	4800	0.0030	3200	0.0023	7950	0.0038	3400	0.0016	2750	0.0017	11200	0.0033
	1/8	10000	0.0038	7950	0.0035	4450	0.0031	2900	0.0025	7500	0.0040	3200	0.0017	2600	0.0017	10500	0.0035
	3/16	6700	0.0056	5300	0.0053	2950	0.0047	1950	0.0037	5000	0.0060	2130	0.0026	1730	0.0026	7000	0.0053
5		6400	0.0059	5050	0.0055	2800	0.0051	1850	0.0040	4750	0.0063	2030	0.0027	1650	0.0028	6700	0.0055
	1/4	5000	0.0075	4000	0.0068	2200	0.0064	1450	0.0051	3750	0.0080	1600	0.0034	1300	0.0035	5300	0.0070
	5/16	4050	0.0094	3200	0.0075	1800	0.0078	1200	0.0064	3000	0.0100	1280	0.0043	1040	0.0044	4250	0.0086
8		4000	0.0095	3150	0.0076	1750	0.0079	1150	0.0065	2950	0.0101	1270	0.0043	1030	0.0044	4200	0.0088
	3/8	3350	0.0113	2650	0.0090	1500	0.0089	1000	0.0071	2500	0.0113	1070	0.0048	870	0.0046	3500	0.0105
10		3200	0.0118	2500	0.0094	1400	0.0094	950	0.0074	2400	0.0119	1020	0.0050	830	0.0048	3350	0.0110
12		2650	0.0132	2100	0.0109	1200	0.0102	800	0.0084	2000	0.0134	850	0.0060	690	0.0058	2800	0.0123
	1/2	2500	0.0140	2000	0.0115	1100	0.0107	750	0.0088	1900	0.0141	800	0.0063	650	0.0061	2600	0.0130
16		2000	0.0157	1600	0.0145	900	0.0127	600	0.0098	1500	0.0157	640	0.0067	510	0.0074	2100	0.0157

- 1) Adjust cutting condition according to the rigidity of machine or work clamp state.
- 2) When rigidity is low and chattering occurs, reduce the rotation and feed rate.
- 3) Wet conditions are for drilling with water soluble cutting fluid.
- 4) In non-water soluble cutting fluid, reduce the rotation and feed rate by 20%.
- 5) Drilling in stainless steel will require pecking. Recommended peck depth is 0.1 x Dc.
- 6) Use air blow for cooling and chip evacuation when drilling dry.

- 7) Use the tables values for drilling depth under 3 x Dc.
- 8) Where chip jamming is a problem, add pecking.
- 9) Retract plane for peck drilling should be set to the top of the hole.
- 10) Recommended peck depth is 0.2 - 1.0 x Dc.

HIGH PERFORMANCE DRILLS

AQUA REVO Drill Regular

Carbide REV D H7 135° 30° H6 2.0-16.0
Material Coating Dia. Tolerance Point Angle Helix Shank Dia. Tol. Size Range

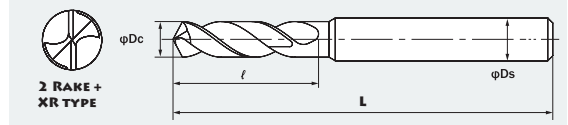

LIST 9862 Metric Sizes

LIST 9863 Wire, Fractional & Letter Sizes

Unit: mm

CARBIDE DRILLS

EDP#	Size	Decimal Equiv.	Wire, Fractional, Letter	Flute Length	Overall Length	Shank Diameter							
	Dc			I	L	Ds							
0771768	2.000	0.0787		15	49	3							
0771780	2.100	0.0827		18									
0771802	2.200	0.0866					3/32						
0771825	2.300	0.0906						20					
1548202	2.381	0.0938							1/8				
0771848	2.400	0.0945								25			
0771860	2.500	0.0984									60		
0771883	2.600	0.1024										28	
0771905	2.700	0.1063											77
1548219	2.778	0.1094											
0771928	2.800	0.1102		40									
0771940	2.900	0.1142			82								
0771963	3.000	0.1181				42							
0771986	3.100	0.1220					82						
1548225	3.175	0.1250						82					
0772007	3.200	0.1260							82				
0772020	3.300	0.1299								82			
0772042	3.400	0.1339									82		
0772065	3.500	0.1378										82	
1548231	3.572	0.1406		82									
0772088	3.600	0.1417			82								
0772100	3.700	0.1457				82							
0772122	3.800	0.1496					82						
0772145	3.900	0.1535						82					
1548248	3.969	0.1563							82				
0772168	4.000	0.1575								82			
1548552	4.039	0.1590									82		
1548569	4.089	0.1610										82	
0774389	4.100	0.1614		82									
0774395	4.200	0.1654			82								
0774400	4.300	0.1693				82							
1548254	4.366	0.1719					82						
0774417	4.400	0.1732						82					
0774423	4.500	0.1772							82				
0774430	4.600	0.1811								82			
0774446	4.700	0.1850									82		
1548260	4.762	0.1875										82	
0774452	4.800	0.1890		82									
0774469	4.900	0.1929			82								
0774475	5.000	0.1969				82							
0772386	5.100	0.2008					82						
1548575	5.105	0.2010						82					
1548277	5.159	0.2031							82				
0772408	5.200	0.2047								82			
0772420	5.300	0.2087									82		
0772443	5.400	0.2126										82	
1548581	5.410	0.2130		82									
0772466	5.500	0.2165			82								
1548283	5.556	0.2187				82							
0772489	5.600	0.2205					82						
1548598	5.613	0.2210						82					
0772500	5.700	0.2244							82				
0772523	5.800	0.2283								82			
0772546	5.900	0.2323									82		
1548290	5.953	0.2344										82	
0772569	6.000	0.2362		82									

EDP#	Size	Decimal Equiv.	Wire, Fractional, Letter	Flute Length	Overall Length	Shank Diameter								
	Dc			I	L	Ds								
0774481	6.100	0.2402		43	84	8								
0774498	6.200	0.2441					1/4							
0774503	6.300	0.2480						F						
1548305	6.350	0.2500							17/64					
0774510	6.400	0.2520								44				
0774526	6.500	0.2559									I			
1548603	6.528	0.2570										J		
0774532	6.600	0.2598											46	
0774549	6.700	0.2638												9/32
1548311	6.747	0.2656												
0774555	6.800	0.2677		91										
0774561	6.900	0.2717			19/64									
1548610	6.909	0.2720				47								
0774578	7.000	0.2756					55							
1548626	7.036	0.2770						Q						
0772678	7.100	0.2795							99					
1548328	7.144	0.2813								57				
0772684	7.200	0.2835									60			
0772690	7.300	0.2874										107		
0772706	7.400	0.2913		62										
0772712	7.500	0.2953			62									
1548334	7.541	0.2969				62								
0772729	7.600	0.2992					62							
0772735	7.700	0.3031						62						
0772741	7.800	0.3071							62					
0772758	7.900	0.3110								62				
1548340	7.937	0.3125									62			
0772764	8.000	0.3150										62		
0774584	8.100	0.3189		62										
0774590	8.200	0.3228			62									
1548632	8.204	0.3230				62								
0774606	8.300	0.3268					62							
1548357	8.334	0.3281						62						
0774612	8.400	0.3307							62					
1548649	8.433	0.3320								62				
0774629	8.500	0.3346									62			
0774635	8.600	0.3386										62		
0774641	8.700	0.3425		62										
1548363	8.731	0.3437			62									
0774658	8.800	0.3465				62								
0774664	8.900	0.3504					62							
0774670	9.000	0.3543						62						
0772873	9.100	0.3583							62					
1548370	9.128	0.3594								62				
0772880	9.200	0.3622									62			
0772896	9.300	0.3661										62		
1548655	9.347	0.3680		62										
0772901	9.400	0.3701			62									
0772918	9.500	0.3740				62								
1548386	9.525	0.3750					62							
0772924	9.600	0.3780						62						
0772930	9.700	0.3819							62					
0772947	9.800	0.3858								62				
0772953	9.900	0.3898									62			
1548392	9.922	0.3906										62		
0772960	10.000	0.3937		62										

HIGH PERFORMANCE DRILLS

CARBIDE DRILLS

EDP#	Size	Decimal Equiv.	Wire, Fractional, Letter	Flute Length	Overall Length	Shank Diameter
	Dc			l	L	Ds
0774687	10.100	0.3976		68	116	12
0774693	10.200	0.4016				
0774709	10.300	0.4055				
1548408	10.319	0.4063	13/32			
0774715	10.400	0.4094				
0774721	10.500	0.4134				
0774738	10.600	0.4173		70	123	14
0774744	10.700	0.4213				
1548414	10.716	0.4219	27/64			
0774750	10.800	0.4252				
0774767	10.900	0.4291				
0774773	11.000	0.4331				
0773078	11.100	0.4370		73	138	14
1548420	11.112	0.4375	7/16			
0773084	11.200	0.4409				
0773090	11.300	0.4449				
0773106	11.400	0.4488				
0773112	11.500	0.4528				
1548437	11.509	0.4531	29/64	76	138	14
0773129	11.600	0.4567				
0773135	11.700	0.4606				
0773141	11.800	0.4646				
0773158	11.900	0.4685				
1548443	11.906	0.4687	15/32			
0773164	12.000	0.4724		79	138	14
0774780	12.100	0.4764				
0774796	12.200	0.4803				
0774801	12.300	0.4843				
1548450	12.303	0.4844	31/64			
0774818	12.400	0.4882				
0774824	12.500	0.4921		81	138	14
0774830	12.600	0.4961				
0774847	12.700	0.5000				
1548466	12.700	0.5000	1/2			
0774853	12.800	0.5039				
0774860	12.900	0.5079				
0774876	13.000	0.5118				

EDP#	Size	Decimal Equiv.	Wire, Fractional, Letter	Flute Length	Overall Length	Shank Diameter
	Dc			l	L	Ds
1548472	13.097	0.5156	33/64	81	148	14
0773273	13.100	0.5157		87		
0773280	13.200	0.5197				
0773296	13.300	0.5236				
0773301	13.400	0.5276				
1548489	13.494	0.5313	17/32			
0773318	13.500	0.5315			90	
0773324	13.600	0.5354				
0773330	13.700	0.5394				
0773347	13.800	0.5433				
1548495	13.891	0.5469	35/64			
0773353	13.900	0.5472		92		
0773360	14.000	0.5512				
0774882	14.100	0.5551				
0774899	14.200	0.5591				
1548500	14.287	0.5625	9/16			
0774904	14.300	0.5630			94	
0774910	14.400	0.5669				
0774927	14.500	0.5709				
0774933	14.600	0.5748				
1548517	14.684	0.5781	37/64			
0774940	14.700	0.5787		97		
0774956	14.800	0.5827				
0774962	14.900	0.5866				
0774979	15.000	0.5906				
1548523	15.081	0.5937	19/32			
0773479	15.100	0.5945			99	
0773485	15.200	0.5984				
0773491	15.300	0.6024				
0773507	15.400	0.6063				
1548530	15.478	0.6094	39/64			
0773513	15.500	0.6102		162		
0773520	15.600	0.6142				
0773536	15.700	0.6181				
0773542	15.800	0.6220				
1548546	15.875	0.6250	5/8			
0773559	15.900	0.6260				
0773565	16.000	0.6299				

LIST 9862, 9863 Standard Cutting Conditions

Work Material		Structural Steel Carbon Steel Cast Iron		Alloy Steel Heat Treated Steel (20 - 30 HRC)		Mold Steel Hardened Steel (30 - 40 HRC)		Hardened Steel (40 - 50 HRC)		Ductile Cast Iron		Stainless Steel (300 Series)		Nickel Alloys Titanium Alloys PH Stainless		Aluminum Alloy	
Speed (SFM)		320 - 330 SFM		255 - 265 SFM		140 - 150 SFM		100 - 105 SFM		245 - 255 SFM		100 - 110 SFM		65-75 SFM		340 - 360 SFM	
Drill Diameter		RPM	Feed (IPR)	RPM	Feed (IPR)	RPM	Feed (IPR)	RPM	Feed (IPR)	RPM	Feed (IPR)	RPM	Feed (IPR)	RPM	Feed (IPR)	RPM	Feed (IPR)
Metric	Fractional																
2		16000	0.0023	12700	0.0023	7200	0.0017	4800	0.0014	11900	0.0023	5000	0.0009	4120	0.0010	16750	0.0022
3		10600	0.0035	8500	0.0033	4800	0.0030	3200	0.0023	7950	0.0038	3400	0.0016	2750	0.0017	11200	0.0033
	1/8	10000	0.0038	7950	0.0035	4450	0.0031	2900	0.0025	7500	0.0040	3200	0.0017	2600	0.0017	10500	0.0035
	3/16	6700	0.0056	5300	0.0053	2950	0.0047	1950	0.0037	5000	0.0060	2130	0.0026	1730	0.0026	7000	0.0053
5		6400	0.0059	5050	0.0055	2800	0.0051	1850	0.0040	4750	0.0063	2030	0.0027	1650	0.0028	6700	0.0055
	1/4	5000	0.0075	4000	0.0068	2200	0.0064	1450	0.0051	3750	0.0080	1600	0.0034	1300	0.0035	5300	0.0070
	5/16	4050	0.0094	3200	0.0075	1800	0.0078	1200	0.0064	3000	0.0100	1280	0.0043	1040	0.0044	4250	0.0086
8		4000	0.0095	3150	0.0076	1750	0.0079	1150	0.0065	2950	0.0101	1270	0.0043	1030	0.0044	4200	0.0088
	3/8	3350	0.0113	2650	0.0090	1500	0.0089	1000	0.0071	2500	0.0113	1070	0.0048	870	0.0046	3500	0.0105
10		3200	0.0118	2500	0.0094	1400	0.0094	950	0.0074	2400	0.0119	1020	0.0050	830	0.0048	3350	0.0110
12		2650	0.0132	2100	0.0109	1200	0.0102	800	0.0084	2000	0.0134	850	0.0060	690	0.0058	2800	0.0123
	1/2	2500	0.0140	2000	0.0115	1100	0.0107	750	0.0088	1900	0.0141	800	0.0063	650	0.0061	2600	0.0130
16		2000	0.0157	1600	0.0145	900	0.0127	600	0.0098	1500	0.0157	640	0.0067	510	0.0074	2100	0.0157

1) Adjust cutting condition according to the rigidity of machine or work clamp state.

2) When rigidity is low and chattering occurs, reduce the rotation and feed rate.

3) Wet conditions are for drilling with water soluble cutting fluid.

4) In non-water soluble cutting fluid, reduce the rotation and feed rate by 20%.

5) Drilling in stainless steel will require pecking. Recommended peck interval is 0.1 x Dc.

6) Use air blow for cooling and chip evacuation when drilling dry.

7) Use the tables values for drilling depth under 3 x Dc.

8) Where chip jamming is a problem, add pecking.

9) Retract plane for peck drilling should be set to the top of the hole.

10) Recommended peck depth is 0.2 - 1.0 x Dc.

HIGH PERFORMANCE DRILLS

AQUA REVO Drill Oil Hole 3D



Carbide REV D H7 140° 26° ~30° H6 3.0-16.0
Material Coating Dia. Tolerance Point Angle Helix Shank Dia. Tol. Size Range

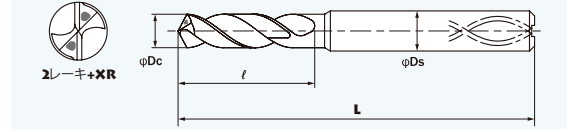

LIST 9872 Metric Sizes

LIST 9873 Wire, Fractional & Letter Sizes

DIN Standard

Unit: mm

CARBIDE DRILLS

EDP#	Size	Decimal Equiv.	Wire, Fractional, Letter	Flute Length	Overall Length	Shank Diameter
	Dc			l	L	Ds
0777800	3.000	0.1181		20	62	6
0777817	3.100	0.1220				
1561530	3.175	0.1250	1/8			
0777823	3.200	0.1260				
0777830	3.300	0.1299				
0777846	3.400	0.1339				
0777852	3.500	0.1378				
1561547	3.572	0.1406	9/64			
0777869	3.600	0.1417				
0777875	3.700	0.1457				
0777881	3.800	0.1496		24	66	6
0777898	3.900	0.1535				
1561553	3.969	0.1563	5/32			
0777903	4.000	0.1575				
1561560	4.039	0.1590	#21			
1561977	4.089	0.1610	#20			
0777910	4.100	0.1614				
0777926	4.200	0.1654				
0777932	4.300	0.1693				
1561576	4.366	0.1719	11/64			
0777949	4.400	0.1732		28	79	8
0777955	4.500	0.1772				
0777961	4.600	0.1811				
0777978	4.700	0.1850				
1561582	4.762	0.1875	3/16			
0777984	4.800	0.1890				
0777990	4.900	0.1929				
0778005	5.000	0.1969				
0778011	5.100	0.2008				
1561599	5.105	0.2010	#7			
1561983	5.159	0.2031	13/64			
0778028	5.200	0.2047		34	102	12
0778034	5.300	0.2087				
0778040	5.400	0.2126				
1561604	5.410	0.2130	#3			
0778057	5.500	0.2165				
1561610	5.556	0.2187	7/32			
0778063	5.600	0.2205				
1561627	5.613	0.2210	#2			
0778070	5.700	0.2244				
0778086	5.800	0.2283				
0778092	5.900	0.2323				
1561633	5.953	0.2344	15/64			
0778108	6.000	0.2362		34	102	12
0778114	6.100	0.2402				
0778120	6.200	0.2441				
0778137	6.300	0.2480				
1561640	6.350	0.2500	1/4			
0778143	6.400	0.2520				
0778150	6.500	0.2559				
1561656	6.528	0.2570	F			
0778166	6.600	0.2598				

EDP#	Size	Decimal Equiv.	Wire, Fractional, Letter	Flute Length	Overall Length	Shank Diameter
	Dc			l	L	Ds
0778172	6.700	0.2638		34	79	8
1561662	6.747	0.2656	17/64			
0778189	6.800	0.2677				
0778195	6.900	0.2717				
1561679	6.909	0.2720	I			
0778200	7.000	0.2756				
1561685	7.036	0.2770	J			
0778217	7.100	0.2795				
1561691	7.144	0.2813	9/32			
0778223	7.200	0.2835				
0778230	7.300	0.2874		41	89	10
0778246	7.400	0.2913				
0778252	7.500	0.2953				
1561707	7.541	0.2969	19/64			
0778269	7.600	0.2992				
0778275	7.700	0.3031				
0778281	7.800	0.3071				
0778298	7.900	0.3110				
1561713	7.937	0.3125	5/16			
0778303	8.000	0.3150				
0778310	8.100	0.3189		47	102	12
0778326	8.200	0.3228				
1561720	8.204	0.3230	P			
0778332	8.300	0.3268				
1561736	8.334	0.3281	21/64			
0778349	8.400	0.3307				
1561742	8.433	0.3320	Q			
0778355	8.500	0.3346				
0778361	8.600	0.3386				
0778378	8.700	0.3425				
1561759	8.731	0.3437	11/32			
0778384	8.800	0.3465		55	102	12
0778390	8.900	0.3504				
0778406	9.000	0.3543				
0778412	9.100	0.3583				
1561765	9.128	0.3594	23/64			
0778429	9.200	0.3622				
0778435	9.300	0.3661				
1561771	9.347	0.3680	U			
0778441	9.400	0.3701				
0778458	9.500	0.3740				
1561788	9.525	0.3750	3/8			
0778464	9.600	0.3780		55	102	12
0778470	9.700	0.3819				
0778487	9.800	0.3858				
0778493	9.900	0.3898				
1561794	9.922	0.3906	25/64			
0778509	10.000	0.3937				
0778515	10.100	0.3976				
0778521	10.200	0.4016				
0778538	10.300	0.4055				
1561800	10.319	0.4063	13/32			

HIGH PERFORMANCE DRILLS

EDP#	Size	Decimal Equiv.	Wire, Fractional, Letter	Flute Length	Overall Length	Shank Diameter
	Dc			I	L	Ds
0778544	10.400	0.4094		55	102	12
0778550	10.500	0.4134				
0778567	10.600	0.4173				
0778573	10.700	0.4213				
1561816	10.716	0.4219	27/64			
0778580	10.800	0.4252				
0778596	10.900	0.4291				
0778601	11.000	0.4331				
0778618	11.100	0.4370				
1561822	11.112	0.4375	7/16			
0778624	11.200	0.4409				
0778630	11.300	0.4449				
0778647	11.400	0.4488				
0778653	11.500	0.4528				
1561839	11.509	0.4531	29/64			
0778660	11.600	0.4567				
0778676	11.700	0.4606				
0778682	11.800	0.4646				
0778699	11.900	0.4685				
1561845	11.906	0.4687	15/32			
0778704	12.000	0.4724		60	107	14
0778710	12.100	0.4764				
0778727	12.200	0.4803				
0778733	12.300	0.4843				
1561851	12.303	0.4844	31/64			
0778740	12.400	0.4882				
0778756	12.500	0.4921				
0778762	12.600	0.4961				
0778779	12.700	0.5000				
1561868	12.700	0.5000	1/2			
0778785	12.800	0.5039				
0778791	12.900	0.5079				
0778807	13.000	0.5118				
1561874	13.097	0.5156	33/64			
0778813	13.100	0.5157				
0778820	13.200	0.5197				

EDP#	Size	Decimal Equiv.	Wire, Fractional, Letter	Flute Length	Overall Length	Shank Diameter
	Dc			I	L	Ds
0778836	13.300	0.5236		60	107	14
0778842	13.400	0.5276				
1561880	13.494	0.5313	17/32			
0778859	13.500	0.5315				
0778865	13.600	0.5354				
0778871	13.700	0.5394				
0778888	13.800	0.5433				
1561897	13.891	0.5469	35/64			
0778894	13.900	0.5472				
0778900	14.000	0.5512				
0778916	14.100	0.5551		65	115	16
0778922	14.200	0.5591				
1561902	14.287	0.5625	9/16			
0778939	14.300	0.5630				
0778945	14.400	0.5669				
0778951	14.500	0.5709				
0778968	14.600	0.5748				
1561919	14.684	0.5781	37/64			
0778974	14.700	0.5787				
0778980	14.800	0.5827				
0778997	14.900	0.5866				
0779001	15.000	0.5906				
1561925	15.081	0.5937	19/32			
0779018	15.100	0.5945				
0779024	15.200	0.5984				
0779030	15.300	0.6024				
0779047	15.400	0.6063				
1561931	15.478	0.6094	39/64			
0779053	15.500	0.6102				
0779060	15.600	0.6142				
0779076	15.700	0.6181				
0779082	15.800	0.6220				
1561948	15.875	0.6250	5/8			
0779099	15.900	0.6260				
0779104	16.000	0.6299				

CARBIDE DRILLS

LIST 9872, 9873 Standard Cutting Conditions

Work Material	Structural Steel Carbon Steel Cast Iron		Alloy Steel Heat Treated Steel (20 - 30 HRC)		Mold Steel Hardened Steel (30 - 40 HRC)		Hardened Steel (40 - 50 HRC)		Ductile Cast Iron		Stainless Steel		PH Stainless		Titanium Alloys		Nickel Alloys Inconel		Aluminum Alloy	
	Speed (SFM)	380 - 400 SFM	310 - 330 SFM	240 - 260 SFM	120 - 140 SFM	320 - 340 SFM	240 - 260 SFM	140 - 160 SFM	115 - 135 SFM	115 - 135 SFM	440 - 460 SFM									
Drill Diameter Metric Fractional	RPM	Feed (IPR)	RPM	Feed (IPR)	RPM	Feed (IPR)	RPM	Feed (IPR)	RPM	Feed (IPR)	RPM	Feed (IPR)	RPM	Feed (IPR)	RPM	Feed (IPR)	RPM	Feed (IPR)	RPM	Feed (IPR)
	3	12700	0.0038	10600	0.0038	8250	0.0035	4200	0.0024	10600	0.0035	8000	0.0031	4850	0.0030	4000	0.0030	4000	0.0018	14550
1/8	12000	0.0040	10000	0.0040	7800	0.0037	4000	0.0026	9950	0.0037	7650	0.0033	4600	0.0032	3700	0.0032	3700	0.0019	13750	0.0044
3/16	7950	0.0060	6650	0.0060	5200	0.0056	2650	0.0038	6650	0.0056	5100	0.0050	3000	0.0047	2450	0.0047	2450	0.0028	9200	0.0066
5	7600	0.0063	6300	0.0063	4950	0.0058	2500	0.0040	6300	0.0059	4850	0.0052	2900	0.0049	2300	0.0049	2300	0.0029	8700	0.0069
1/4	6000	0.0080	5000	0.0080	3900	0.0071	2000	0.0048	5000	0.0076	3800	0.0066	2300	0.0064	1850	0.0064	1850	0.0038	6700	0.0088
5/16	4750	0.0099	4000	0.0099	3150	0.0088	1600	0.0059	4000	0.0086	3050	0.0078	1850	0.0076	1500	0.0076	1500	0.0046	5500	0.0109
8	4700	0.0101	3950	0.0101	3100	0.0087	1550	0.0060	3950	0.0087	3000	0.0079	1800	0.0077	1450	0.0077	1450	0.0047	5450	0.0110
3/8	4000	0.0120	3350	0.0120	2600	0.0098	1350	0.0065	3300	0.0093	2550	0.0089	1550	0.0087	1250	0.0087	1250	0.0056	4600	0.0131
10	3800	0.0126	3200	0.0126	2450	0.0101	1250	0.0070	3200	0.0097	2400	0.0093	1450	0.0091	1150	0.0091	1150	0.0057	4400	0.0138
12	3200	0.0132	2700	0.0132	2050	0.0104	1050	0.0082	2650	0.0098	200	0.0105	1200	0.0103	1000	0.0102	1000	0.0067	3650	0.0151
1/2	3000	0.0140	2500	0.0140	1950	0.0107	1000	0.0083	2500	0.0104	1900	0.0111	1150	0.0108	950	0.0107	950	0.0072	3450	0.0160
16	2400	0.0157	2000	0.0157	1550	0.0118	800	0.0103	2000	0.0122	1500	0.0125	900	0.0122	750	0.0121	750	0.0074	2750	0.0189

- Adjust cutting condition according to the rigidity of machine or work clamp state.
- When rigidity is low and chattering occurs, reduce the rotation and feed rate.
- Wet conditions are for drilling with water soluble cutting fluid.
- In non-water soluble cutting fluid, reduce the rotation and feed rate by 20%.
- Use high pressure internal coolant
- In applications where chip jamming is a problem, use peck drilling.
- Retract plane for peck drilling should be set to the top of the hole.
- Recommended peck depth is 0.2 - 1.0 x Dc.

HIGH PERFORMANCE DRILLS

AQUA REVO Drill Oil Hole 3D

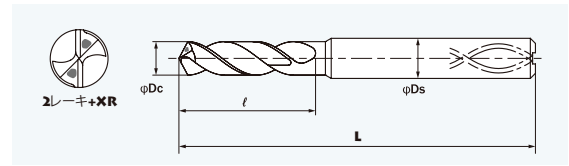
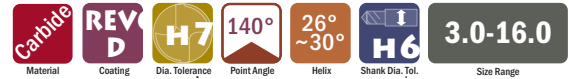

CARBIDE DRILLS

LIST 9864 Metric Sizes

JIS Standard

Unit: mm

EDP #	Size mm	Decimal Equivalent	Flute Length	Overall Length	Shank Diameter
		Dc			
0775180	3.0	0.1181	19	68	3
0775196	3.1	0.1220	21	72	4
0775201	3.2	0.1260			
0775218	3.3	0.1299			
0775224	3.4	0.1339			
0775230	3.5	0.1378			
0775247	3.6	0.1417	23	80	5
0775253	3.7	0.1457			
0775260	3.8	0.1496			
0775276	3.9	0.1535			
0775282	4.0	0.1575			
0775299	4.1	0.1614	26	88	7
0775304	4.2	0.1654			
0775310	4.3	0.1693			
0775327	4.4	0.1732			
0775333	4.5	0.1772			
0775340	4.6	0.1811	29	94	8
0775356	4.7	0.1850			
0775362	4.8	0.1890			
0775379	4.9	0.1929			
0775385	5.0	0.1969			
0775391	5.1	0.2008	32	106	10
0775407	5.2	0.2047			
0775413	5.3	0.2087			
0775420	5.4	0.2126			
0775436	5.5	0.2165			
0775442	5.6	0.2205	34	116	11
0775459	5.7	0.2244			
0775465	5.8	0.2283			
0775471	5.9	0.2323			
0775488	6.0	0.2362			
0775494	6.1	0.2402	37	122	12
0775500	6.2	0.2441			
0775516	6.3	0.2480			
0775522	6.4	0.2520			
0775539	6.5	0.2559			
0775545	6.6	0.2598	39	128	13
0775551	6.7	0.2638			
0775568	6.8	0.2677			
0775574	6.9	0.2717			
0775580	7.0	0.2756			

EDP #	Size mm	Decimal Equivalent	Flute Length	Overall Length	Shank Diameter
		Dc			
0775597	7.1	0.2795	39	94	8
0775602	7.2	0.2835			
0775619	7.3	0.2874			
0775625	7.4	0.2913			
0775631	7.5	0.2953			
0775648	7.6	0.2992	42	100	9
0775654	7.7	0.3031			
0775660	7.8	0.3071			
0775677	7.9	0.3110			
0775683	8.0	0.3150			
0775690	8.1	0.3189	44	106	10
0775705	8.2	0.3228			
0775711	8.3	0.3268			
0775728	8.4	0.3307			
0775734	8.5	0.3346			
0775740	8.6	0.3386	47	112	11
0775757	8.7	0.3425			
0775763	8.8	0.3465			
0775770	8.9	0.3504			
0775786	9.0	0.3543			
0775792	9.1	0.3583	49	118	12
0775808	9.2	0.3622			
0775814	9.3	0.3661			
0775820	9.4	0.3701			
0775837	9.5	0.3740			
0775843	9.6	0.3780	52	124	13
0775850	9.7	0.3819			
0775866	9.8	0.3858			
0775872	9.9	0.3898			
0775889	10.0	0.3937			
0775895	10.1	0.3976	54	130	14
0775900	10.2	0.4016			
0775917	10.3	0.4055			
0775923	10.4	0.4094			
0775930	10.5	0.4134			
0775946	10.6	0.4173	57	136	15
0775952	10.7	0.4213			
0775969	10.8	0.4252			
0775975	10.9	0.4291			
0775981	11.0	0.4331			

HIGH PERFORMANCE DRILLS

EDP #	Size mm	Decimal Equivalent	Flute Length	Overall Length	Shank Diameter
		Dc	ℓ	L	Ds
0775998	11.1	0.4370	60	122	12
0776002	11.2	0.4409			
0776019	11.3	0.4449			
0776025	11.4	0.4488			
0776031	11.5	0.4528			
0776048	11.6	0.4567			
0776054	11.7	0.4606	63	128	13
0776060	11.8	0.4646			
0776077	11.9	0.4685			
0776083	12.0	0.4724			
0776090	12.1	0.4764			
0776105	12.2	0.4803			
0776111	12.3	0.4843	65	128	13
0776128	12.4	0.4882			
0776134	12.5	0.4921			
0776140	12.6	0.4961			
0776157	12.7	0.5000			
0776163	12.8	0.5039			
0776170	12.9	0.5079	68	128	13
0776186	13.0	0.5118			
0776192	13.1	0.5157			
0776208	13.2	0.5197			
0776214	13.3	0.5236			
0776220	13.4	0.5276			
0776237	13.5	0.5315	70	134	14

EDP #	Size mm	Decimal Equivalent	Flute Length	Overall Length	Shank Diameter
		Dc	ℓ	L	Ds
0776243	13.6	0.5354	73	134	14
0776250	13.7	0.5394			
0776266	13.8	0.5433			
0776272	13.9	0.5472			
0776289	14.0	0.5512			
0776295	14.1	0.5551			
0776300	14.2	0.5591	75	140	15
0776317	14.3	0.5630			
0776323	14.4	0.5669			
0776330	14.5	0.5709			
0776346	14.6	0.5748			
0776352	14.7	0.5787			
0776369	14.8	0.5827	78	140	15
0776375	14.9	0.5866			
0776381	15.0	0.5906			
0776398	15.1	0.5945			
0776403	15.2	0.5984			
0776410	15.3	0.6024			
0776426	15.4	0.6063	80	146	16
0776432	15.5	0.6102			
0776449	15.6	0.6142			
0776455	15.7	0.6181			
0776461	15.8	0.6220			
0776478	15.9	0.6260			
0776484	16.0	0.6299	83	146	16

CARBIDE DRILLS

LIST 9864 Standard Cutting Conditions

Work Material	Structural Steel Carbon Steel Cast Iron		Alloy Steel Heat Treated Steel (20 - 30 HRC)		Mold Steel Hardened Steel (30 - 40 HRC)		Hardened Steel (40 - 50 HRC)		Ductile Cast Iron		Stainless Steel		PH Stainless		Titanium Alloys		Nickel Alloys Inconel		Aluminum Alloy			
	Speed (SFM)	380 - 400 SFM	310 - 330 SFM	240 - 260 SFM	120 - 140 SFM	320 - 340 SFM	240 - 260 SFM	140 - 160 SFM	115 - 135 SFM	115 - 135 SFM	440 - 460 SFM											
Drill Diameter	Metric Fractional		RPM		Feed (IPR)		RPM		Feed (IPR)		RPM		Feed (IPR)		RPM		Feed (IPR)		RPM		Feed (IPR)	
3	12700	0.0038	10600	0.0038	8250	0.0035	4200	0.0024	10600	0.0035	8000	0.0031	4850	0.0030	4000	0.0030	4000	0.0018	14550	0.0041		
5	7600	0.0063	6300	0.0063	4950	0.0058	2500	0.0040	6300	0.0059	4850	0.0052	2900	0.0049	2300	0.0049	2300	0.0029	8700	0.0069		
8	4700	0.0101	3950	0.0101	3100	0.0087	1550	0.0060	3950	0.0087	3000	0.0079	1800	0.0077	1450	0.0077	1450	0.0047	5450	0.0110		
10	3800	0.0126	3200	0.0126	2450	0.0101	1250	0.0070	3200	0.0097	2400	0.0093	1450	0.0091	1150	0.0091	1150	0.0057	4400	0.0138		
12	3200	0.0132	2700	0.0132	2050	0.0104	1050	0.0082	2650	0.0098	200	0.0105	1200	0.0103	1000	0.0102	1000	0.0067	3650	0.0151		
16	2400	0.0157	2000	0.0157	1550	0.0118	800	0.0103	2000	0.0122	1500	0.0125	900	0.0122	750	0.0121	750	0.0074	2750	0.0189		

- 1) Adjust cutting condition according to the rigidity of machine or work clamp state.
- 2) When rigidity is low and chattering occurs, reduce the rotation and feed rate.
- 3) Wet conditions are for drilling with water soluble cutting fluid.
- 4) In non-water soluble cutting fluid, reduce the rotation and feed rate by 20%.
- 5) Use high pressure internal coolant
- 6) In applications where chip jamming is a problem, use peck drilling.
- 7) Retract plane for peck drilling should be set to the top of the hole.
- 8) Recommended peck depth is 0.2 - 1.0 x Dc.

HIGH PERFORMANCE DRILLS

AQUA REVO Drill Oil Hole 5D

Carbide REV D H7 140° 26° ~30° H6 3.0-16.0
Material Coating Dia. Tolerance Point Angle Helix Shank Dia. Tol. Size Range

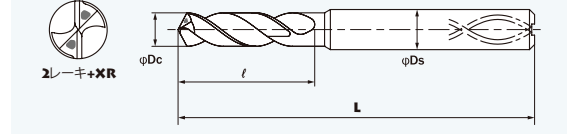

LIST 9874 Metric Sizes

LIST 9875 Wire, Fractional & Letter Sizes

DIN Standard

Unit: mm

CARBIDE DRILLS

EDP#	Size	Decimal Equiv.	Wire, Fractional, Letter	Flute Length	Overall Length	Shank Diameter
	Dc			l	L	Ds
0779110	3.000	0.1181		28	66	
0779127	3.100	0.1220				
1561990	3.175	0.1250	1/8			
0779133	3.200	0.1260				
0779140	3.300	0.1299				
0779156	3.400	0.1339				
0779162	3.500	0.1378				
1562004	3.572	0.1406	9/64			
0779179	3.600	0.1417				
0779185	3.700	0.1457				
0779191	3.800	0.1496		36	74	
0779207	3.900	0.1535				
1562010	3.969	0.1563	5/32			
0779213	4.000	0.1575				
1562027	4.039	0.1590	#21			
1561954	4.089	0.1610	#20			
0779220	4.100	0.1614				
0779236	4.200	0.1654				
0779242	4.300	0.1693				
1562033	4.366	0.1719	11/64			
0779259	4.400	0.1732		44	82	6
0779265	4.500	0.1772				
0779271	4.600	0.1811				
0779288	4.700	0.1850				
1562040	4.762	0.1875	3/16			
0779294	4.800	0.1890				
0779300	4.900	0.1929				
0779316	5.000	0.1969				
0779322	5.100	0.2008				
1562056	5.105	0.2010	#7			
1561960	5.159	0.2031	13/64			
0779339	5.200	0.2047		53	91	8
0779345	5.300	0.2087				
0779351	5.400	0.2126				
1562062	5.410	0.2130	#3			
0779368	5.500	0.2165				
1562079	5.556	0.2187	7/32			
0779374	5.600	0.2205				
1562085	5.613	0.2210	#2			
0779380	5.700	0.2244				
0779397	5.800	0.2283				
0779402	5.900	0.2323				
1562091	5.953	0.2344	15/64			
0779419	6.000	0.2362		53	91	8
0779425	6.100	0.2402				
0779431	6.200	0.2441				
0779448	6.300	0.2480				
1562107	6.350	0.2500	1/4			
0779454	6.400	0.2520				
0779460	6.500	0.2559				
1562113	6.528	0.2570	F			
0779477	6.600	0.2598				

EDP#	Size	Decimal Equiv.	Wire, Fractional, Letter	Flute Length	Overall Length	Shank Diameter
	Dc			l	L	Ds
0779483	6.700	0.2638		53	91	8
1562120	6.747	0.2656	17/64			
0779490	6.800	0.2677				
0779505	6.900	0.2717				
1562136	6.909	0.2720	I			
0779511	7.000	0.2756				
1562142	7.036	0.2770	J			
0779528	7.100	0.2795				
1562159	7.144	0.2813	9/32			
0779534	7.200	0.2835				
0779540	7.300	0.2874		61	103	10
0779557	7.400	0.2913				
0779563	7.500	0.2953				
1562165	7.541	0.2969	19/64			
0779570	7.600	0.2992				
0779586	7.700	0.3031				
0779592	7.800	0.3071				
0779608	7.900	0.3110				
1562171	7.937	0.3125	5/16			
0779614	8.000	0.3150				
0779620	8.100	0.3189		71	118	12
0779637	8.200	0.3228				
1562188	8.204	0.3230	P			
0779643	8.300	0.3268				
1562194	8.334	0.3281	21/64			
0779650	8.400	0.3307				
1562200	8.433	0.3320	Q			
0779666	8.500	0.3346				
0779672	8.600	0.3386				
0779689	8.700	0.3425				
1562216	8.731	0.3437	11/32			
0779695	8.800	0.3465		71	118	12
0779700	8.900	0.3504				
0779717	9.000	0.3543				
0779723	9.100	0.3583				
1562222	9.128	0.3594	23/64			
0779730	9.200	0.3622				
0779746	9.300	0.3661				
1562239	9.347	0.3680	U			
0779752	9.400	0.3701				
0779769	9.500	0.3740				
1562245	9.525	0.3750	3/8			
0779775	9.600	0.3780				
0779781	9.700	0.3819				
0779798	9.800	0.3858				
0779803	9.900	0.3898				
1562251	9.922	0.3906	25/64			
0779810	10.000	0.3937				
0779826	10.100	0.3976				
0779832	10.200	0.4016				
0779849	10.300	0.4055				
1562268	10.319	0.4063	13/32			

HIGH PERFORMANCE DRILLS

EDP#	Size	Decimal Equiv.	Wire, Fractional, Letter	Flute Length	Overall Length	Shank Diameter
	Dc			I	L	Ds
0779855	10.400	0.4094		71	118	12
0779861	10.500	0.4134				
0779878	10.600	0.4173				
0779884	10.700	0.4213				
1562274	10.716	0.4219	27/64			
0779890	10.800	0.4252				
0779906	10.900	0.4291				
0779912	11.000	0.4331				
0779929	11.100	0.4370				
1562280	11.112	0.4375	7/16			
0779935	11.200	0.4409				
0779941	11.300	0.4449				
0779958	11.400	0.4488				
0779964	11.500	0.4528				
1562297	11.509	0.4531	29/64			
0779970	11.600	0.4567				
0779987	11.700	0.4606				
0779993	11.800	0.4646				
0780007	11.900	0.4685				
1562302	11.906	0.4687	15/32			
0780013	12.000	0.4724		77	124	14
0780020	12.100	0.4764				
0780036	12.200	0.4803				
0780042	12.300	0.4843				
1562319	12.303	0.4844	31/64			
0780059	12.400	0.4882				
0780065	12.500	0.4921				
0780071	12.600	0.4961				
0780088	12.700	0.5000				
1562325	12.700	0.5000	1/2			
0780094	12.800	0.5039				
0780100	12.900	0.5079				
0780116	13.000	0.5118				
1562331	13.097	0.5156	33/64			
0780122	13.100	0.5157				
0780139	13.200	0.5197				

EDP#	Size	Decimal Equiv.	Wire, Fractional, Letter	Flute Length	Overall Length	Shank Diameter
	Dc			I	L	Ds
0780145	13.300	0.5236		77	124	14
0780151	13.400	0.5276				
1562348	13.494	0.5313	17/32			
0780168	13.500	0.5315				
0780174	13.600	0.5354				
0780180	13.700	0.5394				
0780197	13.800	0.5433				
1562354	13.891	0.5469	35/64			
0780202	13.900	0.5472				
0780219	14.000	0.5512				
0780225	14.100	0.5551		83	133	16
0780231	14.200	0.5591				
1562360	14.287	0.5625	9/16			
0780248	14.300	0.5630				
0780254	14.400	0.5669				
0780260	14.500	0.5709				
0780277	14.600	0.5748				
1562377	14.684	0.5781	37/64			
0780283	14.700	0.5787				
0780290	14.800	0.5827				
0780305	14.900	0.5866				
0780311	15.000	0.5906				
1562383	15.081	0.5937	19/32			
0780328	15.100	0.5945				
0780334	15.200	0.5984				
0780340	15.300	0.6024				
0780357	15.400	0.6063				
1562390	15.478	0.6094	39/64			
0780363	15.500	0.6102				
0780370	15.600	0.6142				
0780386	15.700	0.6181				
0780392	15.800	0.6220				
1562405	15.875	0.6250	5/8			
0780408	15.900	0.6260				
0780414	16.000	0.6299				

CARBIDE DRILLS

LIST 9874, 9875 Standard Cutting Conditions

Work Material	Structural Steel Carbon Steel Cast Iron		Alloy Steel Heat Treated Steel (20 - 30 HRC)		Mold Steel Hardened Steel (30 - 40 HRC)		Hardened Steel (40 - 50 HRC)		Ductile Cast Iron		Stainless Steel		PH Stainless		Titanium Alloys		Nickel Alloys Inconel		Aluminum Alloy		
	Speed (SFM)	380 - 400 SFM	310 - 330 SFM	240 - 260 SFM	120 - 140 SFM	320 - 340 SFM	240 - 260 SFM	140 - 160 SFM	115 - 135 SFM	115 - 135 SFM	440 - 460 SFM	RPM	Feed (IPR)	RPM	Feed (IPR)	RPM	Feed (IPR)	RPM	Feed (IPR)	RPM	Feed (IPR)
Drill Diameter	Metric	Fractional	RPM	Feed (IPR)	RPM	Feed (IPR)	RPM	Feed (IPR)	RPM	Feed (IPR)	RPM	Feed (IPR)	RPM	Feed (IPR)	RPM	Feed (IPR)	RPM	Feed (IPR)	RPM	Feed (IPR)	
	3	1/8	12700	0.0038	10600	0.0038	8250	0.0035	4200	0.0024	10600	0.0035	8000	0.0031	4850	0.0030	4000	0.0030	4000	0.0018	14550
	3/16	7950	0.0060	6650	0.0060	5200	0.0056	2650	0.0038	6650	0.0056	5100	0.0050	3000	0.0047	2450	0.0047	2450	0.0028	9200	0.0066
5	1/4	6000	0.0080	5000	0.0080	3900	0.0071	2000	0.0048	5000	0.0076	3800	0.0066	2300	0.0064	1850	0.0064	1850	0.0038	6700	0.0088
	5/16	4750	0.0099	4000	0.0099	3150	0.0088	1600	0.0059	4000	0.0086	3050	0.0078	1850	0.0076	1500	0.0076	1500	0.0046	5500	0.0109
8	3/8	4000	0.0120	3350	0.0120	2600	0.0098	1350	0.0065	3300	0.0093	2550	0.0089	1550	0.0087	1250	0.0087	1250	0.0056	4600	0.0131
	1/2	3000	0.0140	2500	0.0140	1950	0.0107	1000	0.0083	2500	0.0104	1900	0.0111	1150	0.0108	950	0.0107	950	0.0072	3450	0.0160
16		2400	0.0157	2000	0.0157	1550	0.0118	800	0.0103	2000	0.0122	1500	0.0125	900	0.0122	750	0.0121	750	0.0074	2750	0.0189

- Adjust cutting condition according to the rigidity of machine or work clamp state.
- When rigidity is low and chattering occurs, reduce the rotation and feed rate.
- Wet conditions are for drilling with water soluble cutting fluid.
- In non-water soluble cutting fluid, reduce the rotation and feed rate by 20%.
- Use high pressure internal coolant
- In applications where chip jamming is a problem, use peck drilling.
- Retract plane for peck drilling should be set to the top of the hole.
- Recommended peck depth is 0.2 - 1.0 x Dc.

HIGH PERFORMANCE DRILLS

AQUA REVO Drill Oil Hole 5D

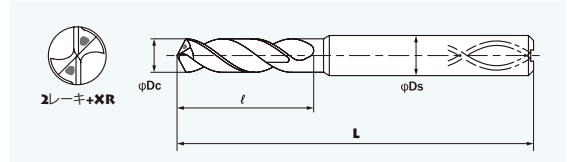
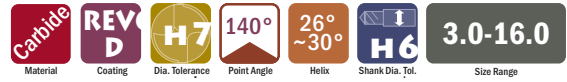

JIS Standard

LIST 9866 Metric Sizes

CARBIDE DRILLS

EDP #	Size mm	Decimal Equivalent	Flute Length	Overall Length	Shank Diameter
	Dc		l	L	Ds
0776490	3.0	0.1181	29	78	3
0776506	3.1	0.1220	33	86	4
0776512	3.2	0.1260			
0776529	3.3	0.1299			
0776535	3.4	0.1339			
0776541	3.5	0.1378			
0776558	3.6	0.1417	37	98	5
0776564	3.7	0.1457			
0776570	3.8	0.1496			
0776587	3.9	0.1535			
0776593	4.0	0.1575			
0776609	4.1	0.1614	41	100	6
0776615	4.2	0.1654			
0776621	4.3	0.1693			
0776638	4.4	0.1732			
0776644	4.5	0.1772			
0776650	4.6	0.1811	46	109	7
0776667	4.7	0.1850			
0776673	4.8	0.1890			
0776680	4.9	0.1929			
0776696	5.0	0.1969			
0776701	5.1	0.2008	50	109	7
0776718	5.2	0.2047			
0776724	5.3	0.2087			
0776730	5.4	0.2126			
0776747	5.5	0.2165			
0776753	5.6	0.2205	54	109	7
0776760	5.7	0.2244			
0776776	5.8	0.2283			
0776782	5.9	0.2323			
0776799	6.0	0.2362			
0776804	6.1	0.2402	58	109	7
0776810	6.2	0.2441			
0776827	6.3	0.2480			
0776833	6.4	0.2520			
0776840	6.5	0.2559			
0776856	6.6	0.2598	58	109	7
0776862	6.7	0.2638			
0776879	6.8	0.2677			
0776885	6.9	0.2717			
0776891	7.0	0.2756			

EDP #	Size mm	Decimal Equivalent	Flute Length	Overall Length	Shank Diameter
	Dc		l	L	Ds
0776907	7.1	0.2795	62	118	8
0776913	7.2	0.2835			
0776920	7.3	0.2874			
0776936	7.4	0.2913			
0776942	7.5	0.2953			
0776959	7.6	0.2992	66	127	9
0776965	7.7	0.3031			
0776971	7.8	0.3071			
0776988	7.9	0.3110			
0776994	8.0	0.3150			
0777009	8.1	0.3189	70	136	10
0777015	8.2	0.3228			
0777021	8.3	0.3268			
0777038	8.4	0.3307			
0777044	8.5	0.3346			
0777050	8.6	0.3386	74	136	10
0777067	8.7	0.3425			
0777073	8.8	0.3465			
0777080	8.9	0.3504			
0777096	9.0	0.3543			
0777101	9.1	0.3583	78	149	11
0777118	9.2	0.3622			
0777124	9.3	0.3661			
0777130	9.4	0.3701			
0777147	9.5	0.3740			
0777153	9.6	0.3780	82	149	11
0777160	9.7	0.3819			
0777176	9.8	0.3858			
0777182	9.9	0.3898			
0777199	10.0	0.3937			
0777204	10.1	0.3976	87	149	11
0777210	10.2	0.4016			
0777227	10.3	0.4055			
0777233	10.4	0.4094			
0777240	10.5	0.4134			
0777256	10.6	0.4173	91	149	11
0777262	10.7	0.4213			
0777279	10.8	0.4252			
0777285	10.9	0.4291			
0777291	11.0	0.4331			

HIGH PERFORMANCE DRILLS

CARBIDE DRILLS

EDP #	Size mm	Decimal Equivalent	Flute Length	Overall Length	Shank Diameter
		Dc	ℓ	L	Ds
0777307	11.1	0.4370	95	158	12
0777313	11.2	0.4409			
0777320	11.3	0.4449			
0777336	11.4	0.4488			
0777342	11.5	0.4528			
0777359	11.6	0.4567	99	167	13
0777365	11.7	0.4606			
0777371	11.8	0.4646			
0777388	11.9	0.4685			
0777394	12.0	0.4724			
0777400	12.1	0.4764	103	176	14
0777416	12.2	0.4803			
0777422	12.3	0.4843			
0777439	12.4	0.4882			
0777445	12.5	0.4921			
0777451	12.6	0.4961	107	185	15
0777468	12.7	0.5000			
0777474	12.8	0.5039			
0777480	12.9	0.5079			
0777497	13.0	0.5118			
0777502	13.1	0.5157	111	194	16
0777519	13.2	0.5197			
0777525	13.3	0.5236			
0777531	13.4	0.5276			
0777548	13.5	0.5315			

EDP #	Size mm	Decimal Equivalent	Flute Length	Overall Length	Shank Diameter
		Dc	ℓ	L	Ds
0777554	13.6	0.5354	115	176	14
0777560	13.7	0.5394			
0777577	13.8	0.5433			
0777583	13.9	0.5472			
0777590	14.0	0.5512			
0777605	14.1	0.5551	119	185	15
0777611	14.2	0.5591			
0777628	14.3	0.5630			
0777634	14.4	0.5669			
0777640	14.5	0.5709			
0777657	14.6	0.5748	124	194	16
0777663	14.7	0.5787			
0777670	14.8	0.5827			
0777686	14.9	0.5866			
0777692	15.0	0.5906			
0777708	15.1	0.5945	128	194	16
0777714	15.2	0.5984			
0777720	15.3	0.6024			
0777737	15.4	0.6063			
0777743	15.5	0.6102			
0777750	15.6	0.6142	132	194	16
0777766	15.7	0.6181			
0777772	15.8	0.6220			
0777789	15.9	0.6260			
0777795	16.0	0.6299			

LIST 9866 Standard Cutting Conditions

Work Material	Structural Steel Carbon Steel Cast Iron		Alloy Steel Heat Treated Steel (20 - 30 HRC)		Mold Steel Hardened Steel (30 - 40 HRC)		Hardened Steel (40 - 50 HRC)		Ductile Cast Iron		Stainless Steel		PH Stainless		Titanium Alloys		Nickel Alloys Inconel		Aluminum Alloy	
Speed (SFM)	380 - 400 SFM		310 - 330 SFM		240 - 260 SFM		120 - 140 SFM		320 - 340 SFM		240 - 260 SFM		140 - 160 SFM		115 - 135 SFM		115 - 135 SFM		440 - 460 SFM	
Drill Diameter Metric	RPM	Feed (IPR)	RPM	Feed (IPR)	RPM	Feed (IPR)	RPM	Feed (IPR)	RPM	Feed (IPR)	RPM	Feed (IPR)	RPM	Feed (IPR)	RPM	Feed (IPR)	RPM	Feed (IPR)	RPM	Feed (IPR)
3	12700	0.0038	10600	0.0038	8250	0.0035	4200	0.0024	10600	0.0035	8000	0.0031	4850	0.0030	4000	0.0030	4000	0.0018	14550	0.0041
5	7600	0.0063	6300	0.0063	4950	0.0058	2500	0.0040	6300	0.0059	4850	0.0052	2900	0.0049	2300	0.0049	2300	0.0029	8700	0.0069
8	4700	0.0101	3950	0.0101	3100	0.0087	1550	0.0060	3950	0.0087	3000	0.0079	1800	0.0077	1450	0.0077	1450	0.0047	5450	0.0110
10	3800	0.0126	3200	0.0126	2450	0.0101	1250	0.0070	3200	0.0097	2400	0.0093	1450	0.0091	1150	0.0091	1150	0.0057	4400	0.0138
12	3200	0.0132	2700	0.0132	2050	0.0104	1050	0.0082	2650	0.0098	200	0.0105	1200	0.0103	1000	0.0102	1000	0.0067	3650	0.0151
16	2400	0.0157	2000	0.0157	1550	0.0118	800	0.0103	2000	0.0122	1500	0.0125	900	0.0122	750	0.0121	750	0.0074	2750	0.0189

- 1) Adjust cutting condition according to the rigidity of machine or work clamp state.
- 2) When rigidity is low and chattering occurs, reduce the rotation and feed rate.
- 3) Wet conditions are for drilling with water soluble cutting fluid.
- 4) In non-water soluble cutting fluid, reduce the rotation and feed rate by 20%.
- 5) Use high pressure internal coolant
- 6) In applications where chip jamming is a problem, use peck drilling.
- 7) Retract plane for peck drilling should be set to the top of the hole.
- 8) Recommended peck depth is 0.2 - 1.0 x Dc.

HIGH PERFORMANCE DRILLS

AQUA REVO Drill Oil Hole 8D

Carbide
Material
REV D
Coating
H7
Dia. Tolerance
140°
Point Angle
26°~30°
Helix
H6
Shank Dia. Tol.
3.0-16.0
Size Range

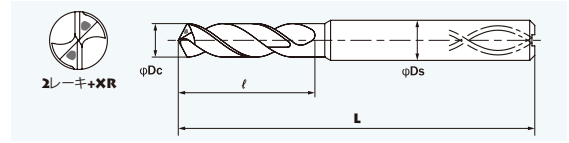

Unit: mm

LIST 9868 Metric Sizes

LIST 9869 Wire, Fractional & Letter Sizes

CARBIDE DRILLS

EDP#	Size	Decimal Equiv.	Wire, Fractional, Letter	Flute Length	Overall Length	Shank Diameter
	Dc			l	L	Ds
0780632	3.000	0.1181		34	81	3
0780649	3.100	0.1220		39	92	4
1571126	3.175	0.1250	1/8			
0780655	3.200	0.1260				
0780661	3.300	0.1299		45	92	4
0780678	3.400	0.1339				
0780684	3.500	0.1378				
1571132	3.572	0.1406	9/64	50	105	5
0780690	3.600	0.1417				
0780706	3.700	0.1457				
0780712	3.800	0.1496		56	105	5
0780729	3.900	0.1535				
1571149	3.969	0.1563	5/32			
0780735	4.000	0.1575		50	105	5
1571155	4.039	0.1590	#21			
1571161	4.089	0.1610	#20			
0780741	4.100	0.1614		62	118	6
0780758	4.200	0.1654				
0780764	4.300	0.1693				
1571178	4.366	0.1719	11/64	68	130	8
0780770	4.400	0.1732				
0780787	4.500	0.1772				
0780793	4.600	0.1811		73	130	8
0780809	4.700	0.1850				
1571184	4.762	0.1875				
0780815	4.800	0.1890		79	130	8
0780821	4.900	0.1929				
0780838	5.000	0.1969				
0780844	5.100	0.2008		73	130	8
1571190	5.105	0.2010	#7			
1571206	5.159	0.2031	13/64			
0780850	5.200	0.2047		79	130	8
0780867	5.300	0.2087				
0780873	5.400	0.2126				
1571212	5.410	0.2130	#3	73	130	8
0780880	5.500	0.2165				
1571229	5.556	0.2187	7/32			
0780896	5.600	0.2205		79	130	8
1571235	5.613	0.2210	#2			
0780901	5.700	0.2244				
0780918	5.800	0.2283		73	130	8
0780924	5.900	0.2323				
1571241	5.953	0.2344	15/64			
0780930	6.000	0.2362		79	130	8
1569949	6.100	0.2402				
1569955	6.200	0.2441				
1569961	6.300	0.2480		79	130	8
1571258	6.350	0.2500	1/4			
1569978	6.400	0.2520				
1569984	6.500	0.2559		79	130	8
1571264	6.528	0.2570	F			
1569990	6.600	0.2598				
1570004	6.700	0.2638		79	130	8

EDP#	Size	Decimal Equiv.	Wire, Fractional, Letter	Flute Length	Overall Length	Shank Diameter
	Dc			l	L	Ds
1571270	6.747	0.2656	17/64	79	130	8
1570010	6.800	0.2677				
1570027	6.900	0.2717				
1571287	6.909	0.2720	I	84	142	8
1570033	7.000	0.2756				
1571293	7.036	0.2770	J			
0781049	7.100	0.2795		84	142	8
1571309	7.144	0.2813	9/32			
0781055	7.200	0.2835				
0781061	7.300	0.2874		90	142	8
0781078	7.400	0.2913				
0781084	7.500	0.2953				
1571315	7.541	0.2969	19/64	90	142	8
0781090	7.600	0.2992				
0781106	7.700	0.3031				
0781112	7.800	0.3071		95	154	10
0781129	7.900	0.3110				
1571321	7.937	0.3125	5/16			
0781135	8.000	0.3150		95	154	10
1570040	8.100	0.3189				
1570056	8.200	0.3228				
1571338	8.204	0.3230	P	95	154	10
1570062	8.300	0.3268				
1571344	8.334	0.3281	21/64			
1570079	8.400	0.3307		101	166	10
1571350	8.433	0.3320	Q			
1570085	8.500	0.3346				
1570091	8.600	0.3386		101	166	10
1570107	8.700	0.3425				
1571367	8.731	0.3437	11/32			
1570113	8.800	0.3465		106	166	10
1570120	8.900	0.3504				
1570136	9.000	0.3543				
0781244	9.100	0.3583		106	166	10
1571373	9.128	0.3594	23/64			
0781250	9.200	0.3622				
0781267	9.300	0.3661		112	182	12
1571380	9.347	0.3680	U			
0781273	9.400	0.3701				
0781280	9.500	0.3740		112	182	12
1571396	9.525	0.3750	3/8			
0781296	9.600	0.3780				
0781301	9.700	0.3819		112	182	12
0781318	9.800	0.3858				
0781324	9.900	0.3898				
1571401	9.922	0.3906	25/64	118	182	12
0781330	10.000	0.3937				
1570142	10.100	0.3976				
1570159	10.200	0.4016		118	182	12
1570165	10.300	0.4055				
1571418	10.319	0.4063	13/32			
1570171	10.400	0.4094		118	182	12
1570188	10.500	0.4134				

HIGH PERFORMANCE DRILLS

CARBIDE DRILLS

EDP#	Size	Decimal Equiv.	Wire, Fractional, Letter	Flute Length	Overall Length	Shank Diameter	EDP#	Size	Decimal Equiv.	Wire, Fractional, Letter	Flute Length	Overall Length	Shank Diameter
	Dc			I	L	Ds		Dc			I	L	Ds
1570194	10.600	0.4173					0781674	13.400	0.5276				
1570200	10.700	0.4213					1571476	13.494	0.5313	17/32	151		
1571424	10.716	0.4219	27/64	124	182		0781680	13.500	0.5315				
1570216	10.800	0.4252					0781697	13.600	0.5354			218	14
1570222	10.900	0.4291					0781702	13.700	0.5394				
1570239	11.000	0.4331					0781719	13.800	0.5433		157		
0781440	11.100	0.4370					1571482	13.891	0.5469	35/64			
1571430	11.112	0.4375	7/16				0781725	13.900	0.5472				
0781456	11.200	0.4409		129		12	0781731	14.000	0.5512				
0781462	11.300	0.4449					1570348	14.100	0.5551				
0781479	11.400	0.4488					1570354	14.200	0.5591				
0781485	11.500	0.4528					1571499	14.287	0.5625	9/16	163		
1571447	11.509	0.4531	29/64		194		1570360	14.300	0.5630				
0781491	11.600	0.4567					1570377	14.400	0.5669				
0781507	11.700	0.4606					1570383	14.500	0.5709			230	
0781513	11.800	0.4646		135			1570390	14.600	0.5748				
0781520	11.900	0.4685					1571504	14.684	0.5781	37/64			
1571453	11.906	0.4687	15/63				1570405	14.700	0.5787		169		
0781536	12.000	0.4724					1570411	14.800	0.5827				
1570245	12.100	0.4764					1570428	14.900	0.5866				
1570251	12.200	0.4803					1570434	15.000	0.5906				
1570268	12.300	0.4843					1571510	15.081	0.5937	19/32			
1571460	12.303	0.4844	31/64	140			0781840	15.100	0.5945				
1570274	12.400	0.4882					0781857	15.200	0.5984				
1570280	12.500	0.4921			206		0781863	15.300	0.6024		174		
1570297	12.600	0.4961					0781870	15.400	0.6063				
1570302	12.700	0.5000	1/2				1571527	15.478	0.6094	39/64			
1570319	12.800	0.5039		146		14	0781886	15.500	0.6102			242	
1570325	12.900	0.5079					0781892	15.600	0.6142				
1570331	13.000	0.5118					0781908	15.700	0.6181				
0781645	13.097	0.5156	33/64				0781914	15.800	0.6220		180		
0781645	13.100	0.5157					1571533	15.875	0.6250	5/8			
0781651	13.200	0.5197		151	218		0781920	15.900	0.6260				
0781668	13.300	0.5236					0781937	16.000	0.6299				

LIST 9868, 9869 Standard Cutting Conditions

Work Material	Structural Steel Carbon Steel Cast Iron	Alloy Steel Heat Treated Steel (20 - 30 HRC)	Mold Steel Hardened Steel (30 - 40 HRC)	Hardened Steel (40 - 50 HRC)	Ductile Cast Iron	Stainless Steel	PH Stainless	Titanium Alloys	Nickel Alloys Inconel	Aluminum Alloy											
Speed (SFM)	380 - 400 SFM	310 - 330 SFM	240 - 260 SFM	120 - 140 SFM	320 - 340 SFM	240 - 260 SFM	140 - 160 SFM	115 - 135 SFM	115 - 135 SFM	440 - 460 SFM											
Drill Diameter	RPM	Feed (IPR)	RPM	Feed (IPR)	RPM	Feed (IPR)	RPM	Feed (IPR)	RPM	Feed (IPR)	RPM	Feed (IPR)	RPM	Feed (IPR)	RPM	Feed (IPR)	RPM	Feed (IPR)			
Metric Fractional																					
3		12700	0.0038	10600	0.0038	8250	0.0035	4200	0.0024	10600	0.0035	8000	0.0031	4850	0.0030	4000	0.0030	4000	0.0018	14550	0.0041
	1/8	12000	0.0040	10000	0.0040	7800	0.0037	4000	0.0026	9950	0.0037	7650	0.0033	4600	0.0032	3700	0.0032	3700	0.0019	13750	0.0044
	3/16	7950	0.0060	6650	0.0060	5200	0.0056	2650	0.0038	6650	0.0056	5100	0.0050	3000	0.0047	2450	0.0047	2450	0.0028	9200	0.0066
5		7600	0.0063	6300	0.0063	4950	0.0058	2500	0.0040	6300	0.0059	4850	0.0052	2900	0.0049	2300	0.0049	2300	0.0029	8700	0.0069
	1/4	6000	0.0080	5000	0.0080	3900	0.0071	2000	0.0048	5000	0.0076	3800	0.0066	2300	0.0064	1850	0.0064	1850	0.0038	6700	0.0088
	5/16	4750	0.0099	4000	0.0099	3150	0.0088	1600	0.0059	4000	0.0086	3050	0.0078	1850	0.0076	1500	0.0076	1500	0.0046	5500	0.0109
8		4700	0.0101	3950	0.0101	3100	0.0087	1550	0.0060	3950	0.0087	3000	0.0079	1800	0.0077	1450	0.0077	1450	0.0047	5450	0.0110
	3/8	4000	0.0120	3350	0.0120	2600	0.0098	1350	0.0065	3300	0.0093	2550	0.0089	1550	0.0087	1250	0.0087	1250	0.0056	4600	0.0131
10		3800	0.0126	3200	0.0126	2450	0.0101	1250	0.0070	3200	0.0097	2400	0.0093	1450	0.0091	1150	0.0091	1150	0.0057	4400	0.0138
12		3200	0.0132	2700	0.0132	2050	0.0104	1050	0.0082	2650	0.0098	200	0.0105	1200	0.0103	1000	0.0102	1000	0.0067	3650	0.0151
	1/2	3000	0.0140	2500	0.0140	1950	0.0107	1000	0.0083	2500	0.0104	1900	0.0111	1150	0.0108	950	0.0107	950	0.0072	3450	0.0160
16		2400	0.0157	2000	0.0157	1550	0.0118	800	0.0103	2000	0.0122	1500	0.0125	900	0.0122	750	0.0121	750	0.0074	2750	0.0189

- 1) Adjust cutting condition according to the rigidity of machine or work clamp state.
- 2) When rigidity is low and chattering occurs, reduce the rotation and feed rate.
- 3) Wet conditions are for drilling with water soluble cutting fluid.
- 4) In non-water soluble cutting fluid, reduce the rotation and feed rate by 20%.
- 5) Use high pressure internal coolant
- 6) In applications where chip jamming is a problem, use peck drilling.
- 7) Retract plane for peck drilling should be set to the top of the hole.
- 8) Recommended peck depth is 0.2 - 1.0 x Dc.

HIGH PERFORMANCE DRILLS

Aqua Drill EX Oil Hole 10D

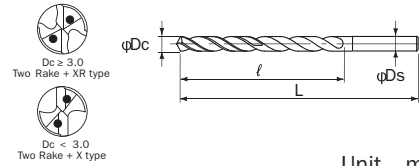
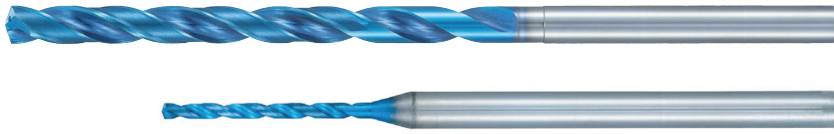

LIST 9612 Metric sizes

Unit _ mm

CARBIDE DRILLS

EDP#	Size	Decimal Equiv.	Flute Length	Overall Length	Shank Diameter
	Dc		ℓ	L	Ds
0733673	1.000	0.0394	13	61	3
0733680	1.100	0.0433	14	63	
0733696	1.200	0.0472	16		
0733701	1.300	0.0512	17	70	
0733718	1.400	0.0551	18		
0733724	1.500	0.0591	20		
0733730	1.600	0.0630	21	80	
0733747	1.700	0.0669	22		
0733753	1.800	0.0709	23		
0733760	1.900	0.0748	25		
0733776	2.000	0.0787	26	89	
0733782	2.100	0.0827	27		
0733799	2.200	0.0866	29		
0733804	2.300	0.0906	30		
0733810	2.400	0.0945	31		
0733827	2.500	0.0984	33	96	
0733833	2.600	0.1024	34		
0733840	2.700	0.1063	35		
0733856	2.800	0.1102	36		
0733862	2.900	0.1142	38		
0726519	3.000	0.1181	39		102
0729788	3.100	0.1220	46		
0729794	3.200	0.1260			
0729800	3.300	0.1299	52		
0729816	3.400	0.1339			
0726525	3.500	0.1378			
0729822	3.600	0.1417	59		
0729839	3.700	0.1457			
0729845	3.800	0.1496			
0729851	3.900	0.1535			
0726531	4.000	0.1575	65		
0729868	4.100	0.1614			
0729874	4.200	0.1654			
0729880	4.300	0.1693			
0729897	4.400	0.1732			
0726548	4.500	0.1772	72		
0729902	4.600	0.1811			
0729919	4.700	0.1850			
0729925	4.800	0.1890			
0729931	4.900	0.1929			
0726554	5.000	0.1969			
0729948	5.100	0.2008	78		
0729954	5.200	0.2047			
0729960	5.300	0.2087			
0729977	5.400	0.2126			
0726560	5.500	0.2165			
0729983	5.600	0.2205			
0729990	5.700	0.2244			
0730003	5.800	0.2283	85		
0730010	5.900	0.2323			
0726577	6.000	0.2362			
0730026	6.100	0.2402			
0730032	6.200	0.2441			
0730049	6.300	0.2480			
0730055	6.400	0.2520			
0726583	6.500	0.2559			

EDP#	Size	Decimal Equiv.	Flute Length	Overall Length	Shank Diameter
	Dc		ℓ	L	Ds
0730078	6.700	0.2638	91	141	7
0730084	6.800	0.2677			
0730090	6.900	0.2717			
0726590	7.000	0.2756	98	148	8
0730106	7.100	0.2795			
0730112	7.200	0.2835			
0730129	7.300	0.2874			
0730135	7.400	0.2913	104	154	9
0726605	7.500	0.2953			
0730141	7.600	0.2992			
0730158	7.700	0.3031			
0730164	7.800	0.3071			
0730170	7.900	0.3110	111	161	10
0726611	8.000	0.3150			
0730187	8.100	0.3189			
0730193	8.200	0.3228			
0730209	8.300	0.3268			
0730215	8.400	0.3307			
0726628	8.500	0.3346	117	167	11
0730221	8.600	0.3386			
0730238	8.700	0.3425			
0730244	8.800	0.3465			
0730250	8.900	0.3504			
0726634	9.000	0.3543			
0730267	9.100	0.3583			
0730273	9.200	0.3622	124	174	12
0730280	9.300	0.3661			
0730296	9.400	0.3701			
0726640	9.500	0.3740			
0730301	9.600	0.3780			
0730318	9.700	0.3819			
0730324	9.800	0.3858			
0730330	9.900	0.3898			
0726657	10.000	0.3937	130	180	13
0730347	10.100	0.3976			
0730353	10.200	0.4016			
0730360	10.300	0.4055			
0730376	10.400	0.4094			
0726663	10.500	0.4134			
0730382	10.600	0.4173			
0730399	10.700	0.4213			
0730404	10.800	0.4252			
0730410	10.900	0.4291	143	203	14
0726670	11.000	0.4331			
0730427	11.100	0.4370			
0730433	11.200	0.4409			
0730440	11.300	0.4449			
0730456	11.400	0.4488			
0726686	11.500	0.4528			
0730462	11.600	0.4567			
0730479	11.700	0.4606			
0730485	11.800	0.4646			
0730491	11.900	0.4685	156	216	15
0726692	12.000	0.4724			

1 per tube

⚠ WARNING: Cancer - www.P65Warnings.ca.gov

HIGH PERFORMANCE DRILLS

Aqua Drill EX Oil Hole 15D

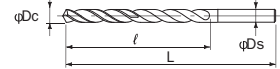

LIST 9614 Metric sizes

LIST 9615 Fractional sizes

• U.S Stock Item ■ Special Order

EDP#	Size	Decimal Equiv.	Wire, Fractional, Letter	Flute Length ℓ	Overall Length L	Shank Diameter Ds	Stock
	Dc			ℓ	L	Ds	
0733879	1.000	0.0394		18	66		•
0733885	1.100	0.0433		20			•
0733891	1.200	0.0472		22	71		•
0733907	1.300	0.0512		23			•
0733913	1.400	0.0551		25			•
0733920	1.500	0.0591		27			•
0733936	1.600	0.0630		29			•
0733942	1.700	0.0669		31	80		•
0733959	1.800	0.0709		32			•
0733965	1.900	0.0748		34			•
0733971	2.000	0.0787		36			•
0733988	2.100	0.0827		38			•
0733994	2.200	0.0866		40	93		•
0734009	2.300	0.0906		41			•
0734015	2.400	0.0945		43			•
0734021	2.500	0.0984		45			•
0734038	2.600	0.1024		47			•
0734044	2.700	0.1063		49	104		•
0734050	2.800	0.1102		50			•
0734067	2.900	0.1142		52			•
0726708	3.000	0.1181		54			•
0730507	3.100	0.1220					•
1519137	3.175	0.1250	1/8				•
0730513	3.200	0.1260					•
0730520	3.300	0.1299		63	113		•
0730536	3.400	0.1339					•
0726714	3.500	0.1378					•
1519143	3.572	0.1406	9/64				•
0730542	3.600	0.1417					•
0730559	3.700	0.1457					•
0730565	3.800	0.1496		72	122		•
0730571	3.900	0.1535					•
1519150	3.969	0.1562	5/32				•
0726720	4.000	0.1575					•
0730588	4.100	0.1614					•
0730594	4.200	0.1654					•
0730600	4.300	0.1693					•
1519166	4.366	0.1719	11/64	81	131		•
0730616	4.400	0.1732					•
0726737	4.500	0.1772					•
0730622	4.600	0.1811					•
0730639	4.700	0.1850					•
1519172	4.763	0.1875	3/16	90	140		•
0730645	4.800	0.1890					•
0730651	4.900	0.1929					•
0726743	5.000	0.1969					•
0730668	5.100	0.2008					•
1519189	5.159	0.2031	13/64				•
0730674	5.200	0.2047					•
0730680	5.300	0.2087		99	149		•
0730697	5.400	0.2126					•
1519195	5.408	0.2129	#3				•
0726750	5.500	0.2165					•
1519200	5.556	0.2187	7/32				•
0730702	5.600	0.2205					•
0730719	5.700	0.2244					•
0730725	5.800	0.2283		108	158		•
0730731	5.900	0.2323					•
1519217	5.953	0.2344	15/64				•
0726766	6.000	0.2362					•
0730748	6.100	0.2402					•
0730754	6.200	0.2441					•
0730760	6.300	0.2480					•
1519223	6.350	0.2500	1/4	117	167		•
0730777	6.400	0.2520					•
0726772	6.500	0.2559					•
0730783	6.600	0.2598					•
0730790	6.700	0.2638			176		•
	6.747	0.2656	17/64				■

EDP#	Size	Decimal Equiv.	Wire, Fractional, Letter	Flute Length ℓ	Overall Length L	Shank Diameter Ds	Stock
	Dc			ℓ	L	Ds	
0730805	6.800	0.2677					•
0730811	6.900	0.2717		126	176	7	•
0726789	7.000	0.2756					•
0730828	7.100	0.2795					•
1519230	7.144	0.2812	9/32				•
0730834	7.200	0.2835		135	185		•
0730840	7.300	0.2874					•
0730857	7.400	0.2913					•
0726795	7.500	0.2953					•
	7.541	0.2969	19/64				■
0730863	7.600	0.2992					•
0730870	7.700	0.3031					•
0730886	7.800	0.3071		144	194		•
0730892	7.900	0.3110					•
1519246	7.938	0.3125	5/16				•
0726800	8.000	0.3150					•
0730908	8.100	0.3189					•
0730914	8.200	0.3228					•
0730920	8.300	0.3268					•
	8.334	0.2969	21/64	153	203		■
0730937	8.400	0.3307					•
0726817	8.500	0.3346					•
0730943	8.600	0.3386					•
0730950	8.700	0.3425					•
1519252	8.731	0.3437	11/32	162	212		•
0730966	8.800	0.3465					•
0730972	8.900	0.3504					•
0726823	9.000	0.3543					•
0730989	9.100	0.3583					•
1519269	9.128	0.3594	23/64				•
0730995	9.200	0.3622					•
0731000	9.300	0.3661		171	221		•
0731016	9.400	0.3701					•
0726830	9.500	0.3740					•
1519275	9.525	0.3750	3/8				•
0731022	9.600	0.3780					•
0731039	9.700	0.3819					•
0731045	9.800	0.3858		180	230		•
0731051	9.900	0.3898					•
1519281	9.922	0.3906	25/64				•
0726846	10.000	0.3937					•
0731068	10.100	0.3976					•
0731074	10.200	0.4016					•
0731080	10.300	0.4055		189	249		•
0731097	10.400	0.4094					•
0726852	10.500	0.4134					•
0731102	10.600	0.4173					•
0731119	10.700	0.4213					•
	10.716	0.2969	27/64	198	258		■
0731125	10.800	0.4252					•
0731131	10.900	0.4291					•
0726869	11.000	0.4331					•
0731148	11.100	0.4370					•
	11.113	0.2969	7/16				■
0731154	11.200	0.4409		207	267		•
0731160	11.300	0.4449					•
0731177	11.400	0.4488					•
0726875	11.500	0.4528					•
	11.509	0.2969	29/64				■
0731183	11.600	0.4567					•
0731190	11.700	0.4606		216	276		•
0731205	11.800	0.4646					•
0731211	11.900	0.4685					•
0726881	12.000	0.4724					•
1519298	12.700	0.5000	1/2	234	294	13	•
1519303	13.494	0.5312	17/32	243	303	14	•
	14.288	0.2969	9/16	261	321	15	■

1 per tube

⚠ WARNING: Cancer - www.P65Warnings.ca.gov

HIGH PERFORMANCE DRILLS

Aqua Drill EX Oil Hole 20D

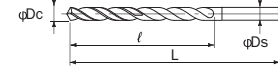

CARBIDE DRILLS

LIST 9616 Metric sizes

LIST 9617 Fractional sizes

• U.S Stock Item

■ Special Order

EDP#	Size	Decimal Equiv.	Wire, Fractional, Letter	Flute Length	Overall Length	Shank Diameter	Stock	
	Dc			ℓ	L	Ds		
0734073	1.000	0.0394		23	71	3	•	
0734080	1.100	0.0433		25	78		•	
0734096	1.200	0.0472		28			•	
0734101	1.300	0.0512		30			•	
0734118	1.400	0.0551		32			•	
0734124	1.500	0.0591		35			•	
0734130	1.600	0.0630		37			•	
0734147	1.700	0.0669		39			•	
0734153	1.800	0.0709		41			•	
0734160	1.900	0.0748		44			•	
0734176	2.000	0.0787		46		105	•	
0734182	2.100	0.0827		48	•			
0734199	2.200	0.0866		51	•			
0734204	2.300	0.0906		53	•			
0734210	2.400	0.0945		55	•			
0734227	2.500	0.0984		58	•			
0734233	2.600	0.1024		60	•			
0734240	2.700	0.1063		62	119		•	
0734256	2.800	0.1102		64			•	
0734262	2.900	0.1142		67			•	
0726898	3.000	0.1181		69		•		
0731228	3.100	0.1220		81		131	•	
1519310	3.175	0.1250	1/8				•	
0731234	3.200	0.1260					•	
0731240	3.300	0.1299					•	
0731257	3.400	0.1339					•	
0726903	3.500	0.1378					•	
1519326	3.572	0.1406	9/64		92		142	•
0731263	3.600	0.1417						•
0731270	3.700	0.1457						•
0731286	3.800	0.1496						•
0731292	3.900	0.1535		•				
1519332	3.969	0.1562	5/32	•				
0726910	4.000	0.1575		104		154		•
0731308	4.100	0.1614						•
0731314	4.200	0.1654						•
0731320	4.300	0.1693						•
1519349	4.366	0.1719	11/64		•			
0731337	4.400	0.1732			•			
0726926	4.500	0.1772			115		165	•
0731343	4.600	0.1811						•
0731350	4.700	0.1850						•
1519355	4.763	0.1875	3/16					•
0731366	4.800	0.1890		•				
0731372	4.900	0.1929		•				
0726932	5.000	0.1969		127		177		•
0731389	5.100	0.2008						•
	5.159	0.2031	13/64					•
0731395	5.200	0.2047						•
0731400	5.300	0.2087			•			
0731417	5.400	0.2126			•			
1519361	5.408	0.2129	#3		138		188	•
0726949	5.500	0.2165						•
1519378	5.556	0.2187	7/32					•
0731423	5.600	0.2205						•

EDP#	Size	Decimal Equiv.	Wire, Fractional, Letter	Flute Length	Overall Length	Shank Diameter	Stock		
	Dc			ℓ	L	Ds			
0731430	5.700	0.2244		138	188	6	•		
0731446	5.800	0.2283					•		
0731452	5.900	0.2323					•		
	5.953	0.2344	15/64				•		
0726955	6.000	0.2362					150	200	•
0731469	6.100	0.2402							•
0731475	6.200	0.2441							•
0731481	6.300	0.2480							•
1519384	6.350	0.2500	1/4						•
0731498	6.400	0.2520							•
0726961	6.500	0.2559		161	211	•			
0731503	6.600	0.2598				•			
0731510	6.700	0.2638				•			
1519390	6.747	0.2656	17/64			•			
0731526	6.800	0.2677				•			
0731532	6.900	0.2717				•			
0726978	7.000	0.2756				173	223	•	
0731549	7.100	0.2795						•	
	7.144	0.2812	9/32					•	
0731555	7.200	0.2835						•	
0731561	7.300	0.2874		•					
0731578	7.400	0.2913		184	234			•	
0726984	7.500	0.2953						•	
1519406	7.541	0.2969	19/64					•	
0731584	7.600	0.2992						•	
0731590	7.700	0.3031						•	
0731606	7.800	0.3071				•			
0731612	7.900	0.3110				196	246	•	
1519412	7.938	0.3125	5/16					•	
0726990	8.000	0.3150						•	
0731629	8.100	0.3189						•	
0731635	8.200	0.3228		•					
0731641	8.300	0.3268		207	257			•	
1519429	8.334	0.3281	21/64					•	
0731658	8.400	0.3307						•	
0727005	8.500	0.3346						•	
0731664	8.600	0.3386						•	
0731670	8.700	0.3425				219	269	•	
1519435	8.731	0.3437	11/32					•	
0731687	8.800	0.3465						•	
0731693	8.900	0.3504						•	
0727011	9.000	0.3543						•	
0731709	9.100	0.3583		230	280			•	
	9.128	0.3594	23/64					•	
0731715	9.200	0.3622						•	
0731721	9.300	0.3661						•	
0731738	9.400	0.3701						230	280
0727028	9.500	0.3740				•			
1519441	9.525	0.3750	3/8			•			
0731744	9.600	0.3780				•			
0731750	9.700	0.3819				•			
0731767	9.800	0.3858				•			
0731773	9.900	0.3898		•					
1519458	9.922	0.3906	25/64	•					
0727034	10.000	0.3937		•					

1 per tube

⚠ WARNING: Cancer - www.P65Warnings.ca.gov

HIGH PERFORMANCE DRILLS

Drilling Conditions - Wet

LIST 9612, 9614, 9615, 9616, 9617

Work Material	Structural Steel Carbon Steel		Alloy Steel Heat Treated Steel (20 - 30 HRC)		Mold Steel Hardened Steel (30 - 40 HRC)		Ductile Cast Iron		Stainless Steel (300 Series)		Nickel Alloys PH Stainless		Aluminum Alloy	
Speed (SFM)	145-180 SFM		130-165 SFM		115-150 SFM		115-150 SFM		80-100 SFM		70-90 SFM			
Drill Diameter Metric	RPM	Feed (IPR)	RPM	Feed (IPR)	RPM	Feed (IPR)	RPM	Feed (IPR)	RPM	Feed (IPR)	RPM	Feed (IPR)	RPM	Feed (IPR)
1.0	15500	0.0009	14000	0.0008	12100	0.0008	12100	0.0011	7750	0.0005	6800	0.0004	Contact Engineering	
1.5	10350	0.0013	9400	0.0012	8100	0.0012	8100	0.0016	5200	0.0007	4500	0.0006		
2.0	7800	0.0020	7000	0.0016	6050	0.0016	6050	0.0021	3900	0.0009	3400	0.0008		
2.5	6200	0.0030	5600	0.0020	4850	0.0020	4850	0.0027	3100	0.0015	2700	0.0013		
Speed (SFM)	320-350 SFM		230-250 SFM		200-230 SFM		200-230 SFM		120-150 SFM		100 - 120 SFM		340 - 360 SFM	
3.0	10350	0.0038	7400	0.0030	6500	0.0030	6500	0.0033	3900	0.0021	3200	0.0014	11300	0.0030
4.0	7800	0.0050	5600	0.0040	4850	0.0040	4850	0.0044	2900	0.0028	2400	0.0019	8500	0.0039
5.0	6200	0.0063	4500	0.0050	3900	0.0050	3900	0.0055	2300	0.0035	1950	0.0024	6800	0.0049
6.0	5200	0.0076	3700	0.0060	3200	0.0060	3200	0.0066	1950	0.0043	1600	0.0028	5700	0.0059
7.0	4400	0.0088	3200	0.0070	2800	0.0070	2800	0.0077	1650	0.0050	1400	0.0033	4850	0.0069
8.0	3900	0.0101	2800	0.0080	2400	0.0080	2400	0.0088	1450	0.0057	1200	0.0038	4250	0.0079
9.0	3450	0.0113	2500	0.0090	2150	0.0090	2150	0.0099	1300	0.0064	1100	0.0043	3800	0.0089
10.0	3100	0.0122	2200	0.0090	1900	0.0090	1900	0.0110	1150	0.0071	970	0.0047	3400	0.0098
11.0	2800	0.0134	2000	0.0100	1800	0.0100	1800	0.0121	1050	0.0078	880	0.0052	3100	0.0108
12.0	2600	0.0142	1850	0.0100	1600	0.0100	1600	0.0132	970	0.0085	810	0.0057	2800	0.0118

Cutting Condition Table Recommendations

- 1) Adjust cutting condition according to the rigidity of machine or work clamp state.
- 2) The table values are for drilling with water-soluble cutting fluid.
- 3) Reduce RPM and feed rate by 30% for non-water soluble coolant.
- 4) Straight shot drilling is possible. However, when experiencing poor chip evacuation please add a peck or review drilling parameters.
- 5) When pecking, set retract slightly below hole entrance.
- 6) Peck increment starting size should be 0.5-1XD.
- 7) Recommended pilot hole depth is 1.5-2XD.
- 8) Recommend the AQDEXOHPLT for pilot hole drilling.

Drilling Conditions - MQL

LIST 9612, 9614, 9615, 9616, 9617

Work Material	Structural Steel Carbon Steel		Alloy Steel Heat Treated Steel (20 - 30 HRC)		Mold Steel Hardened Steel (30 - 40 HRC)		Ductile Cast Iron	
Drill Diameter Metric	RPM	Feed (IPR)	RPM	Feed (IPR)	RPM	Feed (IPR)	RPM	Feed (IPR)
3.0	7600	0.0038	7600	0.0030	5700	0.0030	5700	0.0033
4.0	5700	0.0050	5000	0.0040	4300	0.0040	4300	0.0044
5.0	5100	0.0063	4450	0.0050	3800	0.0050	3800	0.0055
6.0	4200	0.0076	3700	0.0060	3200	0.0060	3200	0.0066
7.0	3600	0.0088	3200	0.0070	2700	0.0070	2700	0.0077
8.0	3200	0.0101	2800	0.0080	2400	0.0080	2400	0.0088
9.0	2800	0.0113	2500	0.0090	2100	0.0090	2100	0.0099
10.0	2550	0.0122	2200	0.0090	1900	0.0090	1900	0.0110
11.0	2300	0.0134	2000	0.0100	1700	0.0100	1700	0.0121
12.0	2100	0.0142	1900	0.0100	1600	0.0100	1600	0.0132

Cutting Condition Table Recommendations

- 1) Adjust cutting condition according to the rigidity of machine or work clamp state.
- 2) The table values are for MQL drilling.
- 3) Straight shot drilling is possible. However, when experiencing poor chip evacuation please add a peck or review drilling parameters.
- 4) When pecking, set retract slightly below hole entrance.
- 5) Peck increment starting size should be 0.5-1XD.
- 6) Recommended pilot hole depth is 1.5-2XD.
- 7) Recommend the AQDEXOHPLT for pilot hole drilling.
- 8) MQL not recommended for stainless and nickel applications. Please use wet drilling conditions.

HIGH PERFORMANCE DRILLS

Aqua Drill EX Oil Hole 25D

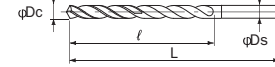

LIST 9618 Metric sizes
LIST 9619 Fractional sizes

• U.S. Stock Item ■ Special Order

CARBIDE DRILLS

EDP#	Size	Decimal Equiv.	Wire, Fractional, Letter	Flute Length	Overall Length	Shank Dia.	Stock
	Dc			ℓ	L	Ds	
1574446	1.000	0.0394		28	76	3	•
1574452	1.100	0.0433		31	86		•
1574469	1.200	0.0472		34			•
1574475	1.300	0.0512		36			•
1574481	1.400	0.0551		39			•
1574498	1.500	0.0591		42			•
1574503	1.600	0.0630		45			•
1574510	1.700	0.0669		48	100		•
1574526	1.800	0.0709		50			•
1574532	1.900	0.0748		53			•
1574549	2.000	0.0787		56			•
1574555	2.100	0.0827		59			•
1574584	2.200	0.0866		62			•
1574590	2.300	0.0906		64	115		•
1574606	2.400	0.0945		67			•
1574612	2.500	0.0984		70			•
1574629	2.600	0.1024		73			•
1574635	2.700	0.1063		76			126
1574641	2.800	0.1102		78		•	
1574561	2.900	0.1142		81	•		
0727040	3.000	0.1181		84	134	•	
0731780	3.100	0.1220		98	148	•	
1519464	3.175	0.1250	1/8			•	
0731796	3.200	0.1260				•	
0731801	3.300	0.1299				•	
0731818	3.400	0.1339				•	
0727057	3.500	0.1378				•	
	3.572	0.1406	9/64	112	162	■	
0731824	3.600	0.1417				•	
0731830	3.700	0.1457				•	
0731847	3.800	0.1496				•	
0731853	3.900	0.1535				•	
1519470	3.969	0.1562	5/32			•	
0727063	4.000	0.1575		126	176	•	
0731860	4.100	0.1614				•	
0731876	4.200	0.1654				•	
0731882	4.300	0.1693				•	
	4.366	0.1719	11/64			■	
0731899	4.400	0.1732				•	
0727070	4.500	0.1772		140	190	•	
0731904	4.600	0.1811				•	
0731910	4.700	0.1850				•	
1519487	4.763	0.1875	3/16			•	

EDP#	Size	Decimal Equiv.	Wire, Fractional, Letter	Flute Length	Overall Length	Shank Dia.	Stock
	Dc			ℓ	L	Ds	
0731927	4.800	0.1890		140	190	5	•
0731933	4.900	0.1929					•
0727086	5.000	0.1969		154	204	6	•
0731940	5.100	0.2008					•
	5.159	0.2031	13/64				•
0731956	5.200	0.2047					•
0731962	5.300	0.2087					•
0731979	5.400	0.2126					•
1519493	5.408	0.2129	#3	168	218	6	•
0727092	5.500	0.2165					•
	5.556	0.2187	7/32				•
0731985	5.600	0.2205					•
0731991	5.700	0.2244					•
0732006	5.800	0.2283					•
0732012	5.900	0.2323		182	232	7	•
	5.953	0.2344	15/64				•
0727108	6.000	0.2362					•
0732029	6.100	0.2402					•
0732035	6.200	0.2441					•
0732041	6.300	0.2480					•
1519509	6.350	0.2500	1/4	196	246	7	•
0732058	6.400	0.2520					•
0727114	6.500	0.2559					•
0732064	6.600	0.2598					•
0732070	6.700	0.2638					•
	6.747	0.2656	17/64				■
0732087	6.800	0.2677		210	260	8	•
0732093	6.900	0.2717					•
0727120	7.000	0.2756					•
0732109	7.100	0.2795					•
	7.144	0.2812	9/32				■
0732115	7.200	0.2835					•
0732121	7.300	0.2874		224	274	8	•
0732138	7.400	0.2913					•
0727137	7.500	0.2953					•
	7.541	0.2969	19/64				■
0732144	7.600	0.2992					•
0732150	7.700	0.3031					•
0732167	7.800	0.3071		280	330	10	•
0732173	7.900	0.3110					•
1519515	7.938	0.3125	5/16				•
0727143	8.000	0.3150					•
1519521	9.525	0.3750	3/8				•

1 per tube

⚠ WARNING: Cancer - www.P65Warnings.ca.gov

HIGH PERFORMANCE DRILLS

Aqua Drill EX Oil Hole 30D

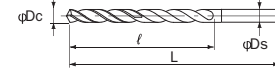

LIST 9620 Metric sizes
LIST 9621 Fractional sizes

• U.S Stock Item ■ Special Order

EDP#	Size	Decimal Equiv.	Wire, Fractional, Letter	Flute Length	Overall Length	Shank Dia.	Stock		
	Dc			ℓ	L	Ds			
1574578	1.000	0.0394		33	78	3	•		
1574658	1.100	0.0433		36	93		•		
1574664	1.200	0.0472		40			•		
1574670	1.300	0.0512		43			•		
1574687	1.400	0.0551		46			•		
1574693	1.500	0.0591		50			•		
1574709	1.600	0.0630		53			110	•	
1574715	1.700	0.0669		56				•	
1574721	1.800	0.0709		59				•	
1574738	1.900	0.0748		63				•	
1574744	2.000	0.0787		66		127		•	
1574750	2.100	0.0827		69	•				
1574767	2.200	0.0866		73	•				
1574773	2.300	0.0906		76	•				
1574780	2.400	0.0945		79	•				
1574796	2.500	0.0984		83	141			•	
1574801	2.600	0.1024		86			•		
1574818	2.700	0.1063		89			•		
1574824	2.800	0.1102		92			•		
1574830	2.900	0.1142		96			149	•	
0727150	3.000	0.1181		99		•			
0732180	3.100	0.1220		116		166		•	
1519538	3.175	0.1250	1/8					•	
0732196	3.200	0.1260						•	
0732201	3.300	0.1299						•	
0732218	3.400	0.1339			•				
0727166	3.500	0.1378			•				
	3.572	0.1406	9/64		132			182	■
0732224	3.600	0.1417							•
0732230	3.700	0.1457					•		
0732247	3.800	0.1496					•		
0732253	3.900	0.1535		•					
1519544	3.969	0.1562	5/32	•					
0727172	4.000	0.1575		•					
0732260	4.100	0.1614		149		199	•		
0732276	4.200	0.1654					•		
0732282	4.300	0.1693					•		
	4.366	0.1719	11/64		•				
0732299	4.400	0.1732			5		215	■	
0727189	4.500	0.1772						•	
0732304	4.600	0.1811						•	
0732310	4.700	0.1850						•	
1519550	4.763	0.1875	3/16					•	
0732327	4.800	0.1890						•	

EDP#	Size	Decimal Equiv.	Wire, Fractional, Letter	Flute Length	Overall Length	Shank Dia.	Stock				
	Dc			ℓ	L	Ds					
0732333	4.900	0.1929		165	215	5	•				
0727195	5.000	0.1969					•				
0732340	5.100	0.2008					182	232	•		
	5.159	0.2031	13/64						•		
0732356	5.200	0.2047							•		
0732362	5.300	0.2087							•		
0732379	5.400	0.2126							•		
	5.410	0.2130	#3						198	248	■
0727200	5.500	0.2165									•
	5.556	0.2187	7/32								•
0732385	5.600	0.2205		215	265	•					
0732391	5.700	0.2244				•					
0732407	5.800	0.2283				•					
0732413	5.900	0.2323				•					
	5.953	0.2344	15/64			231	281	■			
0727217	6.000	0.2362						•			
0732420	6.100	0.2402						•			
0732436	6.200	0.2441						•			
0732442	6.300	0.2480						248	298	•	
1519567	6.350	0.2500	1/4							•	
0732459	6.400	0.2520		•							
0727223	6.500	0.2559		•							
0732465	6.600	0.2598		264	314					•	
0732471	6.700	0.2638								•	
	6.747	0.2656	17/64			•					
0732488	6.800	0.2677				•					
0732494	6.900	0.2717				•					
0727230	7.000	0.2756				264	314			•	
0732500	7.100	0.2795						•			
	7.144	0.2812	9/32					•			
0732516	7.200	0.2835						8	314	•	
0732522	7.300	0.2874								•	
0732539	7.400	0.2913		•							
0727246	7.500	0.2953		•							
	7.541	0.2969	19/64	•							
0732545	7.600	0.2992		•							
0732551	7.700	0.3031		•							
0732568	7.800	0.3071		•							
0732574	7.900	0.3110		•							
	7.938	0.3125	5/16	■							
0727252	8.000	0.3150		•							

1 per tube

⚠ WARNING: Cancer - www.P65Warnings.ca.gov

Drilling Conditions - Wet

LIST 9618, 9619, 9620, 9621

CARBIDE DRILLS

Work Material	Structural Steel Carbon Steel		Alloy Steel Heat Treated Steel (20 - 30 HRC)		Mold Steel Hardened Steel (30 - 40 HRC)		Ductile Cast Iron		Stainless Steel (300 Series)		Nickel Alloys PH Stainless		Aluminum Alloy	
Speed (SFM)	145-180 SFM		130-165 SFM		115-150 SFM		115-150 SFM		80-100 SFM		70-90 SFM			
Drill Diameter Metric	RPM	Feed (IPR)	RPM	Feed (IPR)	RPM	Feed (IPR)	RPM	Feed (IPR)	RPM	Feed (IPR)	RPM	Feed (IPR)	RPM	Feed (IPR)
1.0	15500	0.0008	14000	0.0007	12100	0.0007	12100	0.0010	7750	0.0004	6800	0.0004	Contact Engineering	
1.5	10350	0.0012	9400	0.0011	8100	0.0011	8100	0.0015	5200	0.0006	4500	0.0006		
2.0	7800	0.0018	7000	0.0014	6050	0.0014	6050	0.0020	3900	0.0008	3400	0.0008		
2.5	6200	0.0028	5600	0.0017	4850	0.0017	4850	0.0026	3100	0.0014	2700	0.0012		
Speed (SFM)	320-350 SFM		230-250 SFM		200-230 SFM		200-230 SFM		120-150 SFM		100 - 120 SFM		340 - 360 SFM	
3.0	10350	0.0036	7400	0.0030	6500	0.0028	6500	0.0032	3900	0.0019	3200	0.0013	11300	0.0028
4.0	7800	0.0048	5600	0.0040	4850	0.0039	4850	0.0043	2900	0.0026	2400	0.0018	8500	0.0038
5.0	6200	0.0060	4500	0.0050	3900	0.0043	3900	0.0054	2300	0.0034	1950	0.0023	6800	0.0047
6.0	5200	0.0072	3700	0.0060	3200	0.0054	3200	0.0065	1950	0.0042	1600	0.0027	5700	0.0057
7.0	4400	0.0085	3200	0.0060	2800	0.0065	2800	0.0076	1650	0.0049	1400	0.0032	4850	0.0067
8.0	3900	0.0097	2800	0.0070	2400	0.0074	2400	0.0087	1450	0.0055	1200	0.0037	4250	0.0077

Cutting Condition Table Recommendations

- 1) Adjust cutting condition according to the rigidity of machine or work clamp state.
- 2) The table values are for drilling with water-soluble cutting fluid.
- 3) Reduce RPM and feed rate by 30% for non-water soluble coolant.
- 4) Straight shot drilling is possible. However, when experiencing poor chip evacuation please add a peck or review drilling parameters.
- 5) When pecking, set retract slightly below hole entrance.
- 6) Peck increment starting size should be 0.5-1XD.
- 7) Recommended pilot hole depth is 1.5-2XD.
- 8) Recommend the AQDEXHPLT for pilot hole drilling.

Drilling Conditions - MQL

LIST 9618, 9619, 9620, 9621

Work Material	Structural Steel Carbon Steel		Alloy Steel Heat Treated Steel (20 - 30 HRC)		Mold Steel Hardened Steel (30 - 40 HRC)		Ductile Cast Iron	
Drill Diameter Metric	RPM	Feed (IPR)	RPM	Feed (IPR)	RPM	Feed (IPR)	RPM	Feed (IPR)
3.0	7600	0.0032	7600	0.0028	5700	0.0026	5700	0.0030
4.0	5700	0.0044	5000	0.0038	4300	0.0037	4300	0.0040
5.0	5100	0.0056	4450	0.0046	3800	0.0041	3800	0.0050
6.0	4200	0.0068	3700	0.0052	3200	0.0052	3200	0.0061
7.0	3600	0.0081	3200	0.0057	2700	0.0063	2700	0.0072
8.0	3200	0.0093	2800	0.0067	2400	0.0071	2400	0.0083

Cutting Condition Table Recommendations

- 1) Adjust cutting condition according to the rigidity of machine or work clamp state.
- 2) The table values are for MQL drilling.
- 3) Straight shot drilling is possible. However, when experiencing poor chip evacuation please add a peck or review drilling parameters.
- 4) When pecking, set retract slightly below hole entrance.
- 5) Peck increment starting size should be 0.5-1XD.
- 6) Recommended pilot hole depth is 1.5-2XD.
- 7) Recommend the AQDEXHPLT for pilot hole drilling.
- 8) MQL not recommended for stainless and nickel applications. Please use wet drilling conditions.

HIGH PERFORMANCE DRILLS

Aqua Drill EX Oil Hole 40D

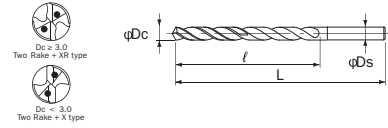

LIST 9626 Metric sizes
LIST 9627 Fractional sizes

• U.S Stock Item ■ Special Order

EDP#	Size	Decimal Equiv.	Wire, Fractional, Letter	Flute Length	Overall Length	Shank Diameter	Stock
	Dc			ℓ	L	Ds	
1575058	1.000	0.0394		43	88	3	•
1575064	1.100	0.0433		47	108		•
1575070	1.200	0.0472		52			•
1575087	1.300	0.0512		56			•
1575093	1.400	0.0551		60	130		•
1575109	1.500	0.0591		65			•
1575115	1.600	0.0630		69			•
1575121	1.700	0.0669		73	152		•
1575138	1.800	0.0709		77			•
1575144	1.900	0.0748		82			•
1575150	2.000	0.0787		76	170		•
1575167	2.100	0.0827		90			•
1575173	2.200	0.0866		95			•
1575180	2.300	0.0906		99	179		•
1575196	2.400	0.0945		103			•
1575201	2.500	0.0984		108			•
1575218	2.600	0.1024		112	201		•
1575224	2.700	0.1063		116			•
1575230	2.800	0.1102		120		•	
1575247	2.900	0.1142		125	222	•	
1519573	3.000	0.1181		129		•	
	3.100	0.1220				•	
1519618	3.175	0.1250	1/8	151	201	4	•
	3.200	0.1260					•
	3.300	0.1299					•
	3.400	0.1339					•
	3.500	0.1378					•
1519580	3.572	0.1406	9/64	172	222	5	•
	3.600	0.1417					•
	3.700	0.1457					•
	3.800	0.1496					•
	3.900	0.1535					•
1519624	3.969	0.1562	5/32	194	244	5	•
1519596	4.000	0.1575					•
	4.100	0.1614					•
	4.200	0.1654					•
	4.300	0.1693					•
	4.400	0.1732				•	

EDP#	Size	Decimal Equiv.	Wire, Fractional, Letter	Flute Length	Overall Length	Shank Diameter	Stock
	Dc			ℓ	L	Ds	
	4.500	0.1772		194	244	5	■
	4.600	0.1811		215	265		■
	4.700	0.1850					■
1519630	4.763	0.1875	3/16	237	287	6	•
	4.800	0.1890					■
	4.900	0.1929					■
	5.000	0.1969		258	308	7	■
	5.100	0.2008					■
	5.200	0.2047					■
	5.300	0.2087		280	330	8	■
	5.400	0.2126					■
1519601	5.500	0.2165					■
	5.600	0.2205		301	351	8	■
	5.700	0.2244					■
	5.800	0.2283					■
	5.900	0.2323		323	373	8	■
	6.000	0.2362					■
	6.100	0.2402					■
	6.200	0.2441		344	394	8	■
	6.300	0.2480					■
1519647	6.350	0.2500	1/4				■
	6.400	0.2520		344	394	8	■
	6.500	0.2559					■
	6.600	0.2598					■
	6.700	0.2638		344	394	8	■
	6.800	0.2677					■
	6.900	0.2717					■
	7.000	0.2756		344	394	8	■
	7.100	0.2795					■
	7.200	0.2835					■
	7.300	0.2874		344	394	8	■
	7.400	0.2913					■
	7.500	0.2953					■
1519653	7.938	0.3125	5/16	344	394	8	•

1 per tube

⚠ WARNING: Cancer - www.P65Warnings.ca.gov

HIGH PERFORMANCE DRILLS

Drilling Conditions - Wet

LIST 9626, 9627

CARBIDE DRILLS

Work Material	Structural Steel Carbon Steel		Alloy Steel Heat Treated Steel (20 - 30 HRC)		Mold Steel Hardened Steel (30 - 40 HRC)		Ductile Cast Iron		Stainless Steel (300 Series)		Nickel Alloys PH Stainless		Aluminum Alloy	
Speed (SFM)	145-180 SFM		130-165 SFM		115-150 SFM		115-150 SFM		80-100 SFM		70-90 SFM			
Drill Diameter Metric	RPM	Feed (IPR)	RPM	Feed (IPR)	RPM	Feed (IPR)	RPM	Feed (IPR)	RPM	Feed (IPR)	RPM	Feed (IPR)	RPM	Feed (IPR)
1.0	15500	0.0006	14000	0.0006	12100	0.0006	12100	0.0008	7750	0.0004	6800	0.0004	Contact Engineering	
1.5	10350	0.0009	9400	0.0008	8100	0.0008	8100	0.0012	5200	0.0006	4500	0.0006		
2.0	7800	0.0015	7000	0.0011	6050	0.0011	6050	0.0016	3900	0.0008	3400	0.0008		
2.5	6200	0.0024	5600	0.0014	4850	0.0014	4850	0.0022	3100	0.0012	2700	0.0011		
Speed (SFM)	320-350 SFM		230-250 SFM		200-230 SFM		200-230 SFM		120-150 SFM		100 - 120 SFM		340 - 360 SFM	
3.0	10350	0.0030	7400	0.0024	6500	0.0024	6500	0.0026	3900	0.0017	3200	0.0012	11300	0.0026
4.0	7800	0.0040	5600	0.0031	4850	0.0031	4850	0.0035	2900	0.0023	2400	0.0017	8500	0.0036
5.0	6200	0.0050	4500	0.0040	3900	0.0040	3900	0.0045	2300	0.0030	1950	0.0022	6800	0.0045
6.0	5200	0.0060	3700	0.0048	3200	0.0048	3200	0.0054	1950	0.0035	1600	0.0026	5700	0.0055
7.0	4400	0.0070	3200	0.0051	2800	0.0051	2800	0.0064	1650	0.0045	1400	0.0031	4850	0.0064
8.0	3900	0.0078	2800	0.0056	2400	0.0056	2400	0.0074	1450	0.0050	1200	0.0036	4250	0.0074

Cutting Condition Table Recommendations

- 1) Adjust cutting condition according to the rigidity of machine or work clamp state.
- 2) The table values are for drilling with water-soluble cutting fluid.
- 3) Reduce RPM and feed rate by 30% for non-water soluble coolant.
- 4) Straight shot drilling is possible. However, when experiencing poor chip evacuation please add a peck or review drilling parameters.
- 5) When pecking, set retract slightly below hole entrance.
- 6) Peck increment starting size should be 0.5-1XD.
- 7) Recommended pilot hole depth is 1.5-2XD.
- 8) Recommend the AQDEXOHPLT for pilot hole drilling.

Drilling Conditions - MQL

LIST 9626, 9627

Work Material	Structural Steel Carbon Steel		Alloy Steel Heat Treated Steel (20 - 30 HRC)		Mold Steel Hardened Steel (30 - 40 HRC)		Ductile Cast Iron	
Drill Diameter Metric	RPM	Feed (IPR)	RPM	Feed (IPR)	RPM	Feed (IPR)	RPM	Feed (IPR)
3.0	7600	0.0030	7600	0.0024	5700	0.0024	5700	0.0026
4.0	5700	0.0040	5000	0.0031	4300	0.0031	4300	0.0035
5.0	5100	0.0050	4450	0.0040	3800	0.0040	3800	0.0045
6.0	4200	0.0060	3700	0.0048	3200	0.0048	3200	0.0054
7.0	3600	0.0070	3200	0.0051	2700	0.0051	2700	0.0064
8.0	3200	0.0078	2800	0.0056	2400	0.0056	2400	0.0074

Cutting Condition Table Recommendations

- 1) Adjust cutting condition according to the rigidity of machine or work clamp state.
- 2) The table values are for MQL drilling.
- 3) Straight shot drilling is possible. However, when experiencing poor chip evacuation please add a peck or review drilling parameters.
- 4) When pecking, set retract slightly below hole entrance.
- 5) Peck increment starting size should be 0.5-1XD.
- 6) Recommended pilot hole depth is 1.5-2XD.
- 7) Recommend the AQDEXOHPLT for pilot hole drilling.
- 8) MQL not recommended for stainless and nickel applications. Please use wet drilling conditions.

HIGH PERFORMANCE DRILLS

Aqua Drill EX Oil Hole Pilot



LIST 9622 Metric sizes
LIST 9623 Fractional sizes

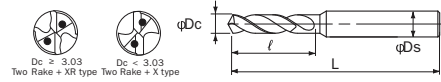

• U.S Stock Item ■ Special Order

EDP#	Size	Decimal Equiv.	For Ø	Flute Length	Overall Length	Shank Diameter
	Dc			ℓ	L	Ds
0734279	1.015	0.0400		3.3	54	3
0734285	1.115	0.0439		3.6	56	
0734291	1.215	0.0478		3.9		
0734307	1.315	0.0518		4.2		
0734313	1.415	0.0557		4.6		
0734320	1.515	0.0596		4.9		
0734336	1.615	0.0636		5.2		
0734342	1.715	0.0675		5.5		
0734359	1.815	0.0715		5.8		
0734365	1.915	0.0754		6.2		
0734371	2.015	0.0793		9		
0734388	2.115	0.0833		11		
0734394	2.215	0.0872				
0734400	2.315	0.0911				
0734416	2.415	0.0951				
0734422	2.515	0.0990				
0734439	2.615	0.1030				
0734445	2.715	0.1069				
0734451	2.815	0.1108				
0734468	2.915	0.1148				
0727624	3.030	0.1193				
0732952	3.130	0.1232			15	
1519660	3.205	0.1262	1/8			
0732969	3.230	0.1272				
0732975	3.330	0.1311				
0732981	3.430	0.1350				
0727630	3.530	0.1390				
1519676	3.601	0.1418	9/64			
0732998	3.630	0.1429				
0733002	3.730	0.1469				
0733019	3.830	0.1508				
0733025	3.930	0.1547				
1519682	3.998	0.1574	5/32			
0727647	4.030	0.1587				
0733031	4.130	0.1626				
0733048	4.230	0.1665				
0733054	4.330	0.1705				
1519699	4.395	0.1730	11/64			
0733060	4.430	0.1744				
0727653	4.530	0.1783				
0733077	4.630	0.1823				
0733083	4.730	0.1862				
1519704	4.792	0.1887	3/16			
0733090	4.830	0.1902				
0733105	4.930	0.1941				
0727660	5.030	0.1980				
0733111	5.130	0.2020				

EDP#	Size	Decimal Equiv.	For Ø	Flute Length	Overall Length	Shank Diameter
	Dc			ℓ	L	Ds
1519710	5.189	0.2043	13/64	24	82	6
0733128	5.230	0.2059				
0733134	5.330	0.2098				
0733140	5.430	0.2138				
1519727	5.440	0.2142	#3			
0727676	5.530	0.2177				
1519733	5.586	0.2199	7/32			
0733157	5.630	0.2217				
0733163	5.730	0.2256				
0733170	5.830	0.2295				
0733186	5.930	0.2335				
1519740	5.983	0.2356	15/64			
0727682	6.030	0.2374				
0733192	6.130	0.2413				
0733208	6.230	0.2453				
0733214	6.330	0.2492				
1519756	6.380	0.2512	1/4			
0733220	6.430	0.2531				
0727699	6.530	0.2571				
0733237	6.630	0.2610				
0733243	6.730	0.2650				
1519762	6.777	0.2668	17/64			
0733250	6.830	0.2689				
0733266	6.930	0.2728				
0727704	7.030	0.2768				
0733272	7.130	0.2807				
1519779	7.173	0.2824	9/32			
0733289	7.230	0.2846				
0733295	7.330	0.2886				
0733300	7.430	0.2925				
0727710	7.530	0.2965				
1519785	7.571	0.2981	19/64			
0733317	7.630	0.3004				
0733323	7.730	0.3043				
0733330	7.830	0.3083				
0733346	7.930	0.3122				
1519791	7.967	0.3137	5/16			
0727727	8.030	0.3161				
0733352	8.130	0.3201				
0733369	8.230	0.3240				
0733375	8.330	0.3280				
1519807	8.364	0.3293	21/64			
0733381	8.430	0.3319				
0727733	8.530	0.3358				
0733398	8.630	0.3398				
0733403	8.730	0.3437				
1519813	8.761	0.3449	11/32			

CARBIDE DRILLS

HIGH PERFORMANCE DRILLS

Aqua Drill EX Oil Hole Pilot

LIST 9622 Metric sizes

LIST 9623 Fractional sizes

CARBIDE DRILLS

EDP#	Size	Decimal Equiv.	For Ø	Flute Length	Overall Length	Shank Diameter
	Dc			ℓ	L	Ds
0733410	8.830	0.3476		40	100	9
0733426	8.930	0.3516		41		
0727740	9.030	0.3555		42		
0733432	9.130	0.3594		43		
1519820	9.158	0.3606	23/64	44		
0733449	9.230	0.3634		45		
0733455	9.330	0.3673		46		
0733461	9.430	0.3713		47		
0727756	9.530	0.3752		48		
1519836	9.555	0.3762	3/8	49	106	10
0733478	9.630	0.3791		50		
0733484	9.730	0.3831		51		
0733490	9.830	0.3870		52		
0733506	9.930	0.3909		53		
1519842	9.951	0.3918	25/64	54		
0727762	10.030	0.3949		55		
0733512	10.130	0.3988		56		
0733529	10.230	0.4028		57		
0733535	10.330	0.4067		58	116	11
0733541	10.430	0.4106		59		
0727779	10.530	0.4146		60		

EDP#	Size	Decimal Equiv.	For Ø	Flute Length	Overall Length	Shank Diameter
	Dc			ℓ	L	Ds
0733558	10.630	0.4185		48		
0733564	10.730	0.4224		49		
1545117	10.745	0.4230	27/64	50	116	11
0733570	10.830	0.4264		51		
0733587	10.930	0.4303		52		
0727785	11.030	0.4343		53		
0733593	11.130	0.4382		54		
1545123	11.142	0.4387	7/16	55		
0733609	11.230	0.4421		56		
0733615	11.330	0.4461		57		
0733621	11.430	0.4500		58		
0727791	11.530	0.4539		59		
1545130	11.549	0.4547	29/64	60	122	12
0733638	11.630	0.4579		61		
0733644	11.730	0.4618		62		
0733650	11.830	0.4657		63		
0733667	11.930	0.4697		64		
0727807	12.030	0.4736		65		
1519859	12.730	0.5012	1/2	57	127	13
1519865	13.524	0.5324	17/32	62	132	14
1545146	14.318	0.5637	9/16	65	140	15

1 per tube

⚠ WARNING: Cancer - www.P65Warnings.ca.gov

Drilling Conditions - Wet

LIST 9622, 9623

Work Material	Structural Steel Carbon Steel		Alloy Steel Heat Treated Steel (20 - 30 HRC)		Mold Steel Hardened Steel (30 - 40 HRC)		Ductile Cast Iron		Stainless Steel (300 Series)		Nickel Alloys PH Stainless		Aluminum Alloy	
	RPM	Feed (IPR)	RPM	Feed (IPR)	RPM	Feed (IPR)	RPM	Feed (IPR)	RPM	Feed (IPR)	RPM	Feed (IPR)	RPM	Feed (IPR)
Speed (SFM)	145-180 SFM		130-165 SFM		115-150 SFM		115-150 SFM		80-100 SFM		70-90 SFM		280-300 SFM	
Drill Diameter Metric	3.03	4.03	5.03	6.03	7.03	8.03	9.03	10.03	11.03	12.03	13.03	14.03	15.03	16.03
1.015	15500	0.0011	14000	0.0010	12100	0.0008	12100	0.0014	7750	0.0005	6800	0.0004	27200	0.0010
1.515	10350	0.0016	9400	0.0015	8100	0.0012	8100	0.0018	5200	0.0007	4500	0.0006	18100	0.0015
2.015	7800	0.0025	7000	0.0020	6050	0.0016	6050	0.0024	3900	0.0010	3400	0.0008	13600	0.0020
2.515	6200	0.0032	5600	0.0025	4850	0.0020	4850	0.0030	3100	0.0015	2700	0.0013	10900	0.0025
Speed (SFM)	320-350 SFM		230-250 SFM		200-230 SFM		200-230 SFM		120-150 SFM		100 - 120 SFM		340 - 360 SFM	
3.03	10350	0.0040	7400	0.0035	6500	0.0030	6500	0.0038	3900	0.0026	3200	0.0020	11300	0.0034
4.03	7800	0.0055	5600	0.0045	4850	0.0040	4850	0.0048	2900	0.0032	2400	0.0025	8500	0.0046
5.03	6200	0.0065	4500	0.0055	3900	0.0050	3900	0.0059	2300	0.0039	1950	0.0030	6800	0.0057
6.03	5200	0.0078	3700	0.0065	3200	0.0060	3200	0.0070	1950	0.0047	1600	0.0033	5700	0.0068
7.03	4400	0.0090	3200	0.0075	2800	0.0070	2800	0.0081	1650	0.0055	1400	0.0038	4850	0.0080
8.03	3900	0.0105	2800	0.0085	2400	0.0080	2400	0.0092	1450	0.0062	1200	0.0042	4250	0.0091
9.03	3450	0.0115	2500	0.0095	2150	0.0090	2150	0.0102	1300	0.0068	1100	0.0048	3800	0.0103
10.03	3100	0.0125	2200	0.0100	1900	0.0090	1900	0.0115	1150	0.0075	970	0.0052	3400	0.0114
11.03	2800	0.0135	2000	0.0105	1800	0.0102	1800	0.012	1050	0.0083	880	0.0057	3100	0.0126
12.03	2600	0.0145	1850	0.0107	1600	0.0105	1600	0.0135	970	0.0090	810	0.0063	2800	0.0137

Cutting Condition Table Recommendations

- 1) Adjust cutting condition according to the rigidity of machine or work clamp state.
- 2) The table values are for drilling with water-soluble cutting fluid.
- 3) Reduce RPM and feed rate by 20% for non-water soluble coolant.
- 4) Use internal coolant.

Drilling Conditions - MQL

LIST 9622, 9623

Work Material	Structural Steel Carbon Steel		Alloy Steel Heat Treated Steel (20 - 30 HRC)		Mold Steel Hardened Steel (30 - 40 HRC)		Ductile Cast Iron			
	RPM	Feed (IPR)	RPM	Feed (IPR)	RPM	Feed (IPR)	RPM	Feed (IPR)		
Drill Diameter Metric	3.03	4.03	5.03	6.03	7.03	8.03	9.03	10.03	11.03	12.03
3.03	7600	0.0040	7600	0.0035	5700	0.0030	5700	0.0038		
4.03	5700	0.0055	5000	0.0045	4300	0.0040	4300	0.0048		
5.03	5100	0.0065	4450	0.0055	3800	0.0050	3800	0.0059		
6.03	4200	0.0078	3700	0.0065	3200	0.0060	3200	0.0070		
7.03	3600	0.0090	3200	0.0075	2700	0.0070	2700	0.0081		
8.03	3200	0.0105	2800	0.0085	2400	0.0080	2400	0.0092		
9.03	2800	0.0115	2500	0.0095	2100	0.0090	2100	0.0102		
10.03	2550	0.0125	2200	0.0100	1900	0.0090	1900	0.0115		
11.03	2300	0.0135	2000	0.0105	1700	0.0102	1700	0.012		
12.03	2100	0.0145	1900	0.0107	1600	0.0105	1600	0.0135		

Cutting Condition Table Recommendations

- 1) Adjust cutting condition according to the rigidity of machine or work clamp state.
- 2) The table values are for MQL drilling.
- 3) Straight shot drilling is possible. However, when experiencing poor chip evacuation please add a peck or review drilling parameters.
- 4) MQL not recommended for stainless and nickel applications. Please use wet drilling conditions.

HIGH PERFORMANCE DRILLS

Aqua Drill EX Oil Hole 3 Flute 3D

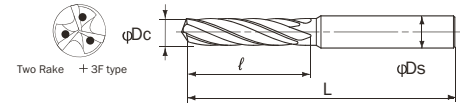
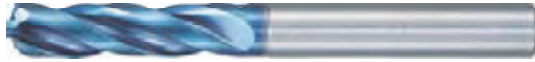

LIST 9826

EDP #	Size	Decimal Equivalent	Flute Length <i>l</i>	Overall Length <i>L</i>	Shank Dia. <i>Ds</i>	Stock
0723876	3.0	0.1181	17	68	3	•
0728483	3.1	0.1220	20	72	4	•
0728490	3.2	0.1260				•
0728505	3.3	0.1299				•
0723882	3.4	0.1339				•
0723899	3.5	0.1378	22	72	4	•
0728511	3.6	0.1417				•
0728528	3.7	0.1457				•
0728534	3.8	0.1496				•
0728540	3.9	0.1535	25	80	5	•
0723904	4.0	0.1575				•
0728557	4.1	0.1614				•
0728563	4.2	0.1654				•
0723910	4.3	0.1693	27	80	5	•
0729736	4.4	0.1732				•
0723927	4.5	0.1772				•
0728570	4.6	0.1811				•
0728586	4.7	0.1850	30	82	6	•
0728592	4.8	0.1890				•
0728608	4.9	0.1929				•
0723933	5.0	0.1969				•
0723940	5.1	0.2008	32	88	7	•
0728614	5.2	0.2047				•
0728620	5.3	0.2087				•
0728637	5.4	0.2126				•
0723956	5.5	0.2165	35	94	8	•
0728643	5.6	0.2205				•
0728650	5.7	0.2244				•
0728666	5.8	0.2283				•
0728672	5.9	0.2323	37	94	8	•
0723962	6.0	0.2362				•
0728689	6.1	0.2402				•
0728695	6.2	0.2441				•
0728700	6.3	0.2480	40	94	8	•
0728717	6.4	0.2520				•
0723979	6.5	0.2559				•
0728723	6.6	0.2598				•
0728730	6.7	0.2638	37	94	8	•
0723985	6.8	0.2677				•
0723991	6.9	0.2717				•
0724006	7.0	0.2756				•
0729742	7.1	0.2795	40	94	8	•
0729759	7.2	0.2835				•
0729765	7.3	0.2874				•
0729771	7.4	0.2913				•
0724012	7.5	0.2953	37	94	8	•
0728746	7.6	0.2992				•
0728752	7.7	0.3031				•
0728769	7.8	0.3071				•
0728775	7.9	0.3110	40	94	8	•
0724029	8.0	0.3150				•

U.S. stock item

EDP #	Size	Decimal Equivalent	Flute Length <i>l</i>	Overall Length <i>L</i>	Shank Dia. <i>Ds</i>	Stock
0728781	8.1	0.3189	42	100	9	•
0728798	8.2	0.3228				•
0728803	8.3	0.3268				•
0728810	8.4	0.3307				•
0724035	8.5	0.3346	45	106	10	•
0724041	8.6	0.3386				•
0728826	8.7	0.3425				•
0728832	8.8	0.3465				•
0728849	8.9	0.3504	47	106	10	•
0724058	9.0	0.3543				•
0728855	9.1	0.3583				•
0728861	9.2	0.3622				•
0728878	9.3	0.3661	50	116	11	•
0728884	9.4	0.3701				•
0724064	9.5	0.3740				•
0728890	9.6	0.3780				•
0728906	9.7	0.3819	52	122	12	•
0728912	9.8	0.3858				•
0728929	9.9	0.3898				•
0724070	10.0	0.3937				•
0728935	10.1	0.3976	55	128	13	•
0728941	10.2	0.4016				•
0724087	10.3	0.4055				•
0728958	10.4	0.4094				•
0724093	10.5	0.4134	57	134	14	•
0728964	10.6	0.4173				•
0728970	10.7	0.4213				•
0728987	10.8	0.4252				•
0728993	10.9	0.4291	60	140	15	•
0724109	11.0	0.4331				•
0729008	11.1	0.4370				•
0729014	11.2	0.4409				•
0729020	11.3	0.4449	62	146	16	•
0729037	11.4	0.4488				•
0724115	11.5	0.4528				•
0729043	11.6	0.4567				•
0729050	11.7	0.4606	65	146	16	•
0729066	11.8	0.4646				•
0729072	11.9	0.4685				•
0724121	12.0	0.4724				•
0724138	12.1	0.4764	67	146	16	•
0724144	12.5	0.4921				•
0724150	13.0	0.5118				•
0724167	13.5	0.5315				•
0724173	14.0	0.5512	70	146	16	•
0724180	14.1	0.5551				•
0724196	14.5	0.5709				•
0724201	15.0	0.5906				•
0724218	15.5	0.6102	72	146	16	•
0724224	15.6	0.6142				•
0724230	16.0	0.6299				•

⚠ WARNING: Cancer - www.P65Warnings.ca.gov

CARBIDE DRILLS

HIGH PERFORMANCE DRILLS

Aqua Drill EX Oil Hole 3 Flute 5D

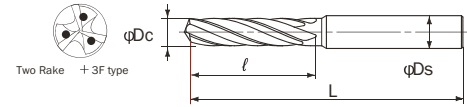

LIST 9820

U.S. stock item

CARBIDE DRILLS

EDP #	Size	Decimal Equivalent	Flute Length	Overall Length	Shank Dia.	Stock
	Dc		ℓ	L	Ds	
0724247	3.0	0.1181	28	78	3	•
0729089	3.1	0.1220				•
0729095	3.2	0.1260				•
0729100	3.3	0.1299	32			•
0724253	3.4	0.1339				•
0724260	3.5	0.1378		86	4	•
0729117	3.6	0.1417				•
0729123	3.7	0.1457				•
0729130	3.8	0.1496	36			•
0729146	3.9	0.1535				•
0724276	4.0	0.1575				•
0729152	4.1	0.1614				•
0729169	4.2	0.1654				•
0724282	4.3	0.1693	40			•
0729175	4.4	0.1732				•
0724299	4.5	0.1772				•
0729181	4.6	0.1811		89	5	•
0729198	4.7	0.1850				•
0729203	4.8	0.1890				•
0729210	4.9	0.1929				•
0724304	5.0	0.1969				•
0724310	5.1	0.2008	44			•
0729226	5.2	0.2047				•
0729232	5.3	0.2087				•
0729249	5.4	0.2126				•
0724327	5.5	0.2165				•
0729255	5.6	0.2205		100	6	•
0729261	5.7	0.2244				•
0729278	5.8	0.2283	48			•
0729284	5.9	0.2323				•
0724333	6.0	0.2362				•
0729290	6.1	0.2402				•
0729306	6.2	0.2441				•
0729312	6.3	0.2480	52			•
0729329	6.4	0.2520				•
0724340	6.5	0.2559		109	7	•
0729335	6.6	0.2598				•
0729341	6.7	0.2638				•
0724356	6.8	0.2677	56			•
0724362	6.9	0.2717				•
0724379	7.0	0.2756				•
0729358	7.1	0.2795				•
0729364	7.2	0.2835				•
0729370	7.3	0.2874	60			•
0729387	7.4	0.2913				•
0724385	7.5	0.2953				•
0729393	7.6	0.2992		118	8	•
0729409	7.7	0.3031				•
0729415	7.8	0.3071	64			•
0729421	7.9	0.3110				•
0724391	8.0	0.3150				•

EDP #	Size	Decimal Equivalent	Flute Length	Overall Length	Shank Dia.	Stock
	Dc		ℓ	L	Ds	
0729438	8.1	0.3189				•
0729444	8.2	0.3228				•
0729450	8.3	0.3268	68			•
0729467	8.4	0.3307				•
0724407	8.5	0.3346				•
0724413	8.6	0.3386		127	9	•
0729473	8.7	0.3425				•
0729480	8.8	0.3465	72			•
0729496	8.9	0.3504				•
0724420	9.0	0.3543				•
0729501	9.1	0.3583				•
0729518	9.2	0.3622				•
0729524	9.3	0.3661	76			•
0729530	9.4	0.3701				•
0724436	9.5	0.3740				•
0729547	9.6	0.3780				•
0729553	9.7	0.3819	80			•
0729560	9.8	0.3858				•
0729576	9.9	0.3898				•
0724442	10.0	0.3937				•
0729582	10.1	0.3976				•
0729599	10.2	0.4016				•
0724459	10.3	0.4055	84			•
0729604	10.4	0.4094				•
0724465	10.5	0.4134		149	11	•
0729610	10.6	0.4173				•
0729627	10.7	0.4213				•
0729633	10.8	0.4252	88			•
0729640	10.9	0.4291				•
0724471	11.0	0.4331				•
0729656	11.1	0.4370				•
0729662	11.2	0.4409				•
0729679	11.3	0.4449	92			•
0729685	11.4	0.4488				•
0724488	11.5	0.4528		158	12	•
0729691	11.6	0.4567				•
0729707	11.7	0.4606				•
0729713	11.8	0.4646	96			•
0729720	11.9	0.4685				•
0724494	12.0	0.4724				•
0724500	12.1	0.4764				•
0724516	12.5	0.4921	100		13	•
0724522	13.0	0.5118	104			•
0724539	13.5	0.5315	108			•
0724545	14.0	0.5512	112	176	14	•
0724551	14.1	0.5551				•
0724568	14.5	0.5709	116		15	•
0724574	15.0	0.5906	120			•
0724580	15.5	0.6102	124			•
0724597	15.6	0.6142		194	16	•
0724602	16.0	0.6299	128			•

Standard Drilling Conditions

LIST 9826, 9820

⚠ WARNING: Cancer - www.P65Warnings.ca.gov

Note:

- 1) Adjust drilling conditions according to the rigidity of machine or work clamp state.
- 2) Use the table values as starting parameters. Adjust per your machine & set up as required.
- 3) Above table values are for drilling water soluble cutting fluid. For non-water soluble cutting fluid reduce the RPM and feed rates by 20%
- 4) Use Internal Coolant. If drilling more than 3xD or 5xD use peck drill cycle (G83).
- 5) Peck Depth interval = 1xD

Formulas: $RPM = \frac{SFM \times 3.82}{\text{Drill Dia.}}$

Drill Dia.

Feed rate(in/min): $RPM \times IPR$

Work Material	Cast Irons/Carbon Steel		Alloy Steels/Pre-Hardened (20-30 HRC)		Mild Steels/Hardened (30-40 HRC)		Hardened Steels (40-50 HRC)		Cast Irons		Stainless Steel (300-Series)		Cast Aluminum		
	Speed (SFM)	Drilling Diameter	325-330 SFM	260-265 SFM	225-230 SFM	170-175 SFM	260-265 SFM	160-165 SFM	260-450 SFM	RPM	Feed (IPR)	RPM	Feed (IPR)		
3	0.118	10,700	0.005	8,500	0.005	7,450	0.004	5,600	0.004	8,500	0.005	5,300	0.004	14,800	0.007
4	0.157	8,000	0.006	6,400	0.006	5,600	0.005	4,200	0.005	6,400	0.006	4,000	0.006	11,200	0.009
6	0.236	5,300	0.010	4,250	0.009	3,750	0.008	2,800	0.006	4,250	0.009	2,650	0.008	7,400	0.010
8	0.315	4,000	0.013	3,200	0.013	2,800	0.011	2,100	0.010	3,200	0.013	2,000	0.011	5,600	0.013
10	0.394	3,200	0.016	2,550	0.016	2,250	0.014	1,700	0.0125	2,550	0.016	1,600	0.014	4,500	0.016
12	0.472	2,650	0.019	2,100	0.019	1,850	0.017	1,400	0.015	2,100	0.019	1,350	0.016	3,700	0.019
14	0.551	2,250	0.020	1,800	0.020	1,600	0.016	1,200	0.014	1,800	0.019	1,150	0.016	3,200	0.022
16	0.630	2,000	0.022	1,600	0.022	1,400	0.019	1,050	0.016	1,600	0.022	1,000	0.019	2,200	0.032

NACHI

High Performance Micro Drills

New Aqua REVO Micro Drill in 5D and 10D Lengths

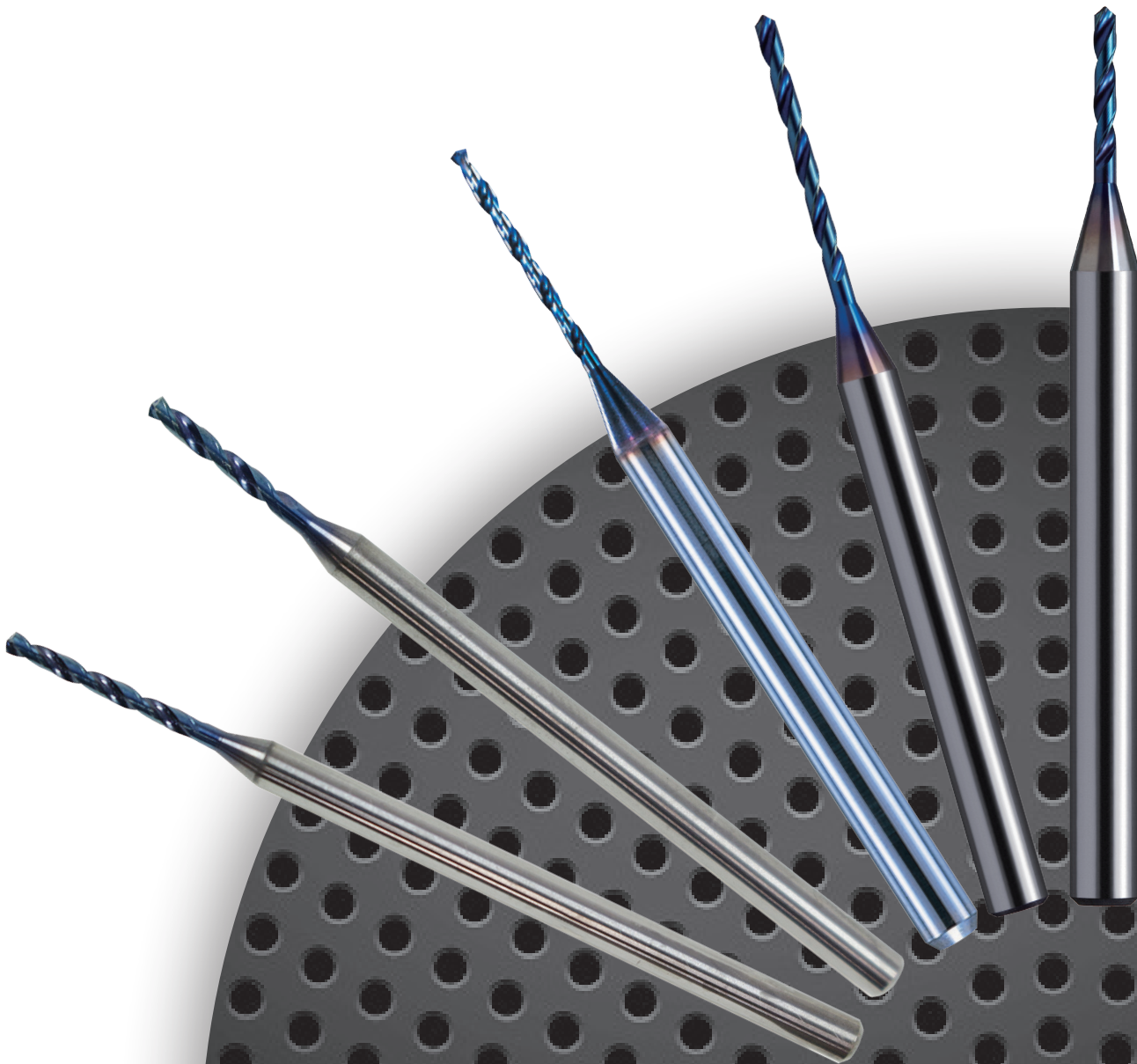

Aqua REVO Drill Micro 5D



Carbide REVO D SEE FOOTNOTE AFTER TABLE 120° 135° 30° h6 0.50-1.99

Material Coating *Dia. Tolerance **Point Angle Dc ≤ 1.09 **Point Angle Dc > 1.09 Helix Shank Dia. Tol. Size Range

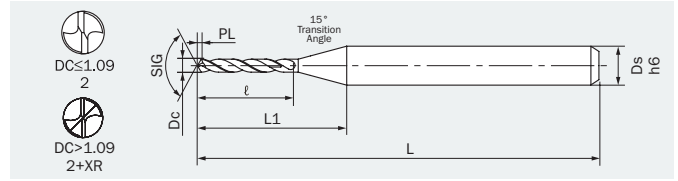

CARBIDE DRILLS

LIST 9878 Metric sizes

Unit: mm

EDP #	Size mm	Decimal Equivalent	Flute Length	Neck Length	Overall Length	Shank Diameter
	Dc	ℓ	L1	L	Ds	
0786515	0.50	0.0197	3.5	8.7	38	3
0786521	0.51	0.0201	3.8	8.9		
0786538	0.52	0.0205				
0786544	0.53	0.0209				
0786550	0.54	0.0213				
0786567	0.55	0.0217				
0786573	0.56	0.0220	4.2	9.2		
0786580	0.57	0.0224				
0786596	0.58	0.0228				
0786601	0.59	0.0232				
0786618	0.60	0.0236				
0786624	0.61	0.0240	4.5	9.4		
0786630	0.62	0.0244				
0786647	0.63	0.0248				
0786653	0.64	0.0252				
0786660	0.65	0.0256				
0786676	0.66	0.0260	4.9	9.7		
0786682	0.67	0.0264				
0786699	0.68	0.0268				
0786704	0.69	0.0272				
0786710	0.70	0.0276				
0786727	0.71	0.0280	5.2	9.9		
0786733	0.72	0.0283				
0786740	0.73	0.0287				
0786756	0.74	0.0291				
0786762	0.75	0.0295				
0786779	0.76	0.0299	5.6	10.2		
0786785	0.77	0.0303				
0786791	0.78	0.0307				
0786807	0.79	0.0311				
0786813	0.80	0.0315				
0786820	0.81	0.0319	5.9	10.4		
0786836	0.82	0.0323				
0786842	0.83	0.0327				
0786859	0.84	0.0331				
0786865	0.85	0.0335				
0786871	0.86	0.0339	6.3	10.7		
0786888	0.87	0.0343				
0786894	0.88	0.0346				
0786900	0.89	0.0350				
0786916	0.90	0.0354				

EDP #	Size mm	Decimal Equivalent	Flute Length	Neck Length	Overall Length	Shank Diameter
	Dc	ℓ	L1	L	Ds	
0786922	0.91	0.0358	6.6	10.9	38	3
0786939	0.92	0.0362				
0786945	0.93	0.0366				
0786951	0.94	0.0370				
0786968	0.95	0.0374				
0786974	0.96	0.0378	7.0	11.3		
0786980	0.97	0.0382				
0786997	0.98	0.0386				
0787001	0.99	0.0390				
0787018	1.00	0.0394				
0787024	1.01	0.0398	7.4	12		
0787030	1.02	0.0402				
0787047	1.03	0.0406				
0787053	1.04	0.0409				
0787060	1.05	0.0413				
0787076	1.06	0.0417	7.7	12.3		
0787082	1.07	0.0421				
0787099	1.08	0.0425				
0787104	1.09	0.0429				
0787110	1.10	0.0433				
0787127	1.11	0.0437	8.1	12.6		
0787133	1.12	0.0441				
0787140	1.13	0.0445				
0787156	1.14	0.0449				
0787162	1.15	0.0453				
0787179	1.16	0.0457	8.4	12.8		
0787185	1.17	0.0461				
0787191	1.18	0.0465				
0787207	1.19	0.0469				
0787213	1.20	0.0472				
0787220	1.21	0.0476	8.8	13.1		
0787236	1.22	0.0480				
0787242	1.23	0.0484				
0787259	1.24	0.0488				
0787265	1.25	0.0492				
0787271	1.26	0.0496	9.1	13.3		
0787288	1.27	0.0500				
0787294	1.28	0.0504				
0787300	1.29	0.0508				
0787316	1.30	0.0512				

HIGH PERFORMANCE DRILLS

LIST 9878 Metric sizes

EDP #	Size mm	Decimal Equivalent	Flute Length	Neck Length	Overall Length	Shank Diameter
		Dc	ℓ	L1	L	Ds
0787322	1.31	0.0516				
0787339	1.32	0.0520				
0787345	1.33	0.0524	9.5	13.6		
0787351	1.34	0.0528				
0787368	1.35	0.0531				
0787374	1.36	0.0535				
0787380	1.37	0.0539				
0787397	1.38	0.0543	9.8	13.8		
0787402	1.39	0.0547				
0787419	1.40	0.0551				
0787425	1.41	0.0555				
0787431	1.42	0.0559				
0787448	1.43	0.0563	10.2	14.1		
0787454	1.44	0.0567				
0787460	1.45	0.0571			38	
0787477	1.46	0.0575				
0787483	1.47	0.0579				
0787490	1.48	0.0583	10.5	14.3		3
0787505	1.49	0.0587				
0787511	1.50	0.0591				
0787528	1.51	0.0594				
0787534	1.52	0.0598				
0787540	1.53	0.0602	10.9	14.6		
0787557	1.54	0.0606				
0787563	1.55	0.0610				
0787570	1.56	0.0614				
0787586	1.57	0.0618				
0787592	1.58	0.0622	11.3	14.9		
0787608	1.59	0.0626				
0787614	1.60	0.0630				
0787620	1.61	0.0634				
0787637	1.62	0.0638				
0787643	1.63	0.0642	11.6	15.1	45	
0787650	1.64	0.0646				
0787666	1.65	0.0650				

EDP #	Size mm	Decimal Equivalent	Flute Length	Neck Length	Overall Length	Shank Diameter
		Dc	ℓ	L1	L	Ds
0787672	1.66	0.0654				
0787689	1.67	0.0657				
0787695	1.68	0.0661	12.0	15.4		
0787700	1.69	0.0665				
0787717	1.70	0.0669				
0787723	1.71	0.0673				
0787730	1.72	0.0677				
0787746	1.73	0.0681	12.3	15.6		
0787752	1.74	0.0685				
0787769	1.75	0.0689				
0787775	1.76	0.0693				
0787781	1.77	0.0697				
0787798	1.78	0.0701	12.7	15.9		
0787803	1.79	0.0705				
0787810	1.80	0.0709				
0787826	1.81	0.0713				
0787832	1.82	0.0717				
0787849	1.83	0.0720	13.0	16.1	45	3
0787855	1.84	0.0724				
0787861	1.85	0.0728				
0787878	1.86	0.0732				
0787884	1.87	0.0736				
0787890	1.88	0.0740	13.3	16.4		
0787906	1.89	0.0744				
0787912	1.90	0.0748				
0787929	1.91	0.0752				
0787935	1.92	0.0756				
0787941	1.93	0.0760	13.7	16.7		
0787958	1.94	0.0764				
0787964	1.95	0.0768				
0787970	1.96	0.0772				
0787987	1.97	0.0776	14.0	16.9		
0787993	1.98	0.0780				
0788008	1.99	0.0783				

*Tolerance of diameter is 0 to -0.009mm.

**Point angle is 120° for diameters 0.50 to 1.09mm or less and 135° for diameters over 1.09 to 1.99mm.

LIST 9878 Standard Wet Cutting Conditions

Work Material	Carbon Steel, Cast Iron (200 HB)		Alloy Steel (20 - 30 HRC)		Mold Steel (30 - 40 HRC)		Hardened Steel (40 - 55 HRC)		Ductile Cast Iron		Stainless Steel		PH Stainless		Aluminum Alloy	
	RPM	Feed (IPR)	RPM	Feed (IPR)	RPM	Feed (IPR)	RPM	Feed (IPR)	RPM	Feed (IPR)	RPM	Feed (IPR)	RPM	Feed (IPR)	RPM	Feed (IPR)
0.5	25500	0.0012	19100	0.0008	15900	0.0008	12750	0.0008	12600	0.0008	5600	0.0007	5600	0.0007	30000	0.0012
1	15000	0.0024	9900	0.0016	8500	0.0016	7500	0.0016	9900	0.0016	4200	0.0011	4200	0.0009	25000	0.0024
1.1	15000	0.0026	9900	0.0017	8500	0.0017	7500	0.0017	9900	0.0017	4100	0.0012	4100	0.0010	25000	0.0026
1.6	11940	0.0038	7900	0.0025	7000	0.0025	6000	0.0025	7900	0.0025	4000	0.0013	3200	0.0012	20000	0.0038
1.9	10050	0.0045	6700	0.0030	5900	0.0030	5030	0.0030	6700	0.0030	3350	0.0015	2700	0.0015	16760	0.0045

1. Adjust cutting condition according to the rigidity of the machine and work holding
2. If the machine you are using has rotation limitations, reduce the rotation and feed rate by the same ratio.
3. Wet condition refers to drilling with water soluble content.
4. In non-water soluble coolant, reduce the rotation and feed rate by 20%.
5. Please use pecking regardless of the hole depth.
6. Retract plane for pecking should return to the top of the hole.
7. Recommended peck increment is 0.2-0.5 x Dc.
8. Direct flood coolant along the work piece and not directly at the drill.

HIGH PERFORMANCE DRILLS

Aqua REVO Drill Micro 10D

Carbide
Material
REVO D
Coating
SEE FOOTNOTE AFTER TABLE
*Dia. Tolerance
120°
**Point Angle Dc ≤ 1.09
135°
**Point Angle Dc > 1.09
30°
Helix
h6
Shank Dia. Tol.
0.50-1.99
Size Range

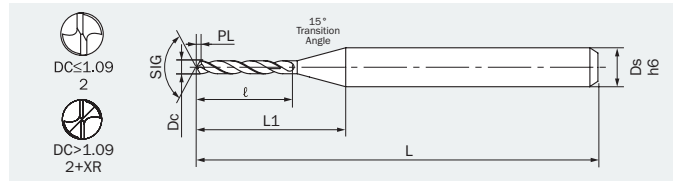

CARBIDE DRILLS

LIST 9880 Metric sizes

EDP #	Size mm	Decimal Equivalent	Flute Length	Neck Length	Overall Length	Shank Diameter
	Dc	ℓ	L1	L	Ds	
0788014	0.50	0.0197	6.0	11.2	38	3
0788020	0.51	0.0201	6.6	11.7		
0788037	0.52	0.0205				
0788043	0.53	0.0209				
0788050	0.54	0.0213				
0788066	0.55	0.0217				
0788072	0.56	0.0220	7.2	12.2		
0788089	0.57	0.0224				
0788095	0.58	0.0228				
0788100	0.59	0.0232				
0788117	0.60	0.0236				
0788123	0.61	0.0240	7.8	12.7		
0788130	0.62	0.0244				
0788146	0.63	0.0248				
0788152	0.64	0.0252				
0788169	0.65	0.0256				
0788175	0.66	0.0260	8.4	13.2		
0788181	0.67	0.0264				
0788198	0.68	0.0268				
0788203	0.69	0.0272				
0788210	0.70	0.0276				
0788226	0.71	0.0280	9.0	13.7		
0788232	0.72	0.0283				
0788249	0.73	0.0287				
0788255	0.74	0.0291				
0788261	0.75	0.0295				
0788278	0.76	0.0299	9.6	14.2		
0788284	0.77	0.0303				
0788290	0.78	0.0307				
0788306	0.79	0.0311				
0788312	0.80	0.0315				
0788329	0.81	0.0319	10.2	14.7		
0788335	0.82	0.0323				
0788341	0.83	0.0327				
0788358	0.84	0.0331				
0788364	0.85	0.0335				
0788370	0.86	0.0339	10.8	15.2		
0788387	0.87	0.0343				
0788393	0.88	0.0346				
0788409	0.89	0.0350				
0788415	0.90	0.0354				

Unit: mm

EDP #	Size mm	Decimal Equivalent	Flute Length	Neck Length	Overall Length	Shank Diameter
	Dc	ℓ	L1	L	Ds	
0788421	0.91	0.0358	11.4	15.7	45	3
0788438	0.92	0.0362				
0788444	0.93	0.0366				
0788450	0.94	0.0370				
0788467	0.95	0.0374				
0788473	0.96	0.0378	12.0	16.3		
0788480	0.97	0.0382				
0788496	0.98	0.0386				
0788501	0.99	0.0390				
0788518	1.00	0.0394				
0788524	1.01	0.0398	12.6	17.2		
0788530	1.02	0.0402				
0788547	1.03	0.0406				
0788553	1.04	0.0409				
0788560	1.05	0.0413				
0788576	1.06	0.0417	13.2	17.8		
0788582	1.07	0.0421				
0788599	1.08	0.0425				
0788604	1.09	0.0429				
0788610	1.10	0.0433				
0788627	1.11	0.0437	13.8	18.3		
0788633	1.12	0.0441				
0788640	1.13	0.0445				
0788656	1.14	0.0449				
0788662	1.15	0.0453				
0788679	1.16	0.0457	14.4	18.8		
0788685	1.17	0.0461				
0788691	1.18	0.0465				
0788707	1.19	0.0469				
0788713	1.20	0.0472				
0788720	1.21	0.0476	15.0	19.3		
0788736	1.22	0.0480				
0788742	1.23	0.0484				
0788759	1.24	0.0488				
0788765	1.25	0.0492				
0788771	1.26	0.0496	15.6	19.8		
0788788	1.27	0.0500				
0788794	1.28	0.0504				
0788800	1.29	0.0508				
0788816	1.30	0.0512				

HIGH PERFORMANCE DRILLS

LIST 9880 Metric sizes

EDP #	Size mm	Decimal Equivalent	Flute Length	Neck Length	Overall Length	Shank Diameter
		Dc	ℓ	L1	L	Ds
0788822	1.31	0.0516				
0788839	1.32	0.0520				
0788845	1.33	0.0524	16.2	20.3		
0788851	1.34	0.0528				
0788868	1.35	0.0531				
0788874	1.36	0.0535				
0788880	1.37	0.0539				
0788897	1.38	0.0543	16.8	20.8		
0788902	1.39	0.0547				
0788919	1.40	0.0551			45	
0788925	1.41	0.0555				
0788931	1.42	0.0559				
0788948	1.43	0.0563	17.4	21.3		
0788954	1.44	0.0567				
0788960	1.45	0.0571				
0788977	1.46	0.0575				
0788983	1.47	0.0579				
0788990	1.48	0.0583	18.0	21.8		3
0789004	1.49	0.0587				
0789010	1.50	0.0591				
0789027	1.51	0.0594				
0789033	1.52	0.0598				
0789040	1.53	0.0602	18.6	22.3		
0789056	1.54	0.0606				
0789062	1.55	0.0610				
0789079	1.56	0.0614				
0789085	1.57	0.0618				
0789091	1.58	0.0622	19.2	22.8	50	
0789107	1.59	0.0626				
0789113	1.60	0.0630				
0789120	1.61	0.0634				
0789136	1.62	0.0638				
0789142	1.63	0.0642	19.8	23.3		
0789159	1.64	0.0646				
0789165	1.65	0.0650				

EDP #	Size mm	Decimal Equivalent	Flute Length	Neck Length	Overall Length	Shank Diameter
		Dc	ℓ	L1	L	Ds
0789171	1.66	0.0654				
0789188	1.67	0.0657				
0789194	1.68	0.0661	20.4	23.8		
0789200	1.69	0.0665				
0789216	1.70	0.0669				
0789222	1.71	0.0673				
0789239	1.72	0.0677				
0789245	1.73	0.0681	21.0	24.3		
0789251	1.74	0.0685				
0789268	1.75	0.0689				
0789274	1.76	0.0693				
0789280	1.77	0.0697				
0789297	1.78	0.0701	21.6	24.8		
0789302	1.79	0.0705				
0789319	1.80	0.0709				
0789325	1.81	0.0713				
0789331	1.82	0.0717				
0789348	1.83	0.0720	22.2	25.3	50	3
0789354	1.84	0.0724				
0789360	1.85	0.0728				
0789377	1.86	0.0732				
0789383	1.87	0.0736				
0789390	1.88	0.0740	22.8	25.9		
0789405	1.89	0.0744				
0789411	1.90	0.0748				
0789428	1.91	0.0752				
0789434	1.92	0.0756				
0789440	1.93	0.0760	23.4	26.4		
0789457	1.94	0.0764				
0789463	1.95	0.0768				
0789470	1.96	0.0772				
0789486	1.97	0.0776				
0789492	1.98	0.0780	23.9	26.8		
0789508	1.99	0.0783				

CARBIDE DRILLS

*Tolerance of diameter is 0 to -0.009mm.

**Point angle is 120° for diameters 0.50 to 1.09mm or less and 135° for diameters over 1.09 to 1.99mm.

LIST 9880 Standard Wet Cutting Conditions

Work Material	Carbon Steel, Cast Iron (200 HB)		Alloy Steel (20 - 30 HRC)		Mold Steel (30 - 40 HRC)		Hardened Steel (40 - 55 HRC)		Ductile Cast Iron		Stainless Steel		PH Stainless		Aluminum Alloy	
	RPM	Feed (IPR)	RPM	Feed (IPR)	RPM	Feed (IPR)	RPM	Feed (IPR)	RPM	Feed (IPR)	RPM	Feed (IPR)	RPM	Feed (IPR)	RPM	Feed (IPR)
0.5	25500	0.0012	19100	0.0008	15900	0.0008	12750	0.0008	12600	0.0008	5600	0.0007	5600	0.0007	30000	0.0012
1	15000	0.0024	9900	0.0016	8500	0.0016	7500	0.0016	9900	0.0016	4200	0.0011	4200	0.0009	25000	0.0024
1.1	15000	0.0026	9900	0.0017	8500	0.0017	7500	0.0017	9900	0.0017	4100	0.0012	4100	0.0010	25000	0.0026
1.6	11940	0.0038	7900	0.0025	7000	0.0025	6000	0.0025	7900	0.0025	4000	0.0013	3200	0.0012	20000	0.0038
1.9	10050	0.0045	6700	0.0030	5900	0.0030	5030	0.0030	6700	0.0030	3350	0.0015	2700	0.0015	16760	0.0045

1. Adjust cutting condition according to the rigidity of the machine and work holding
2. If the machine you are using has rotation limitations, reduce the rotation and feed rate by the same ratio.
3. Wet condition refers to drilling with water soluble content.
4. In non-water soluble coolant, reduce the rotation and feed rate by 20%.
5. Please use pecking regardless of the hole depth.
6. Retract plane for pecking should return to the top of the hole.
7. Recommended peck increment is 0.2-0.5 x Dc.
8. Direct flood coolant along the work piece and not directly at the drill.

HIGH PERFORMANCE DRILLS

Aqua Drill Micro Solid Carbide

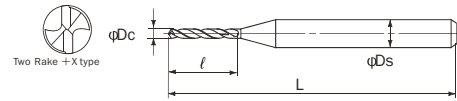

LIST 9544 Metric Range 0.20 to 1.99

CARBIDE DRILLS

EDP#	Size	Decimal Equiv.	Flute Length	Overall Length	Shank Diameter
	Dc		ℓ	L	Ds
0634002	0.20	0.0079	2.5	38	3
0634019	0.21	0.0083			
0634025	0.22	0.0087			
0634031	0.23	0.0091			
0634048	0.24	0.0094			
0634054	0.25	0.0098			
0634060	0.26	0.0102			
0634077	0.27	0.0106			
0634083	0.28	0.0110			
0634090	0.29	0.0114			
0634105	0.30	0.0118	3		
0634111	0.31	0.0122			
0634128	0.32	0.0126			
0634134	0.33	0.0130			
0634140	0.34	0.0134			
0634157	0.35	0.0138	4		
0634163	0.36	0.0142			
0634170	0.37	0.0146			
0634186	0.38	0.0150			
0634192	0.39	0.0154			
0634208	0.40	0.0157	5		
0634214	0.41	0.0161			
0634220	0.42	0.0165			
0634237	0.43	0.0169			
0634243	0.44	0.0173			
0634250	0.45	0.0177			
0634266	0.46	0.0181			
0634272	0.47	0.0185			
0634289	0.48	0.0189			
0634295	0.49	0.0193			
0634300	0.50	0.0197	6		
0634317	0.51	0.0201			
0634323	0.52	0.0205			
0634330	0.53	0.0209			
0634346	0.54	0.0213			
0634352	0.55	0.0217			
0634369	0.56	0.0220			
0634375	0.57	0.0224			
0634381	0.58	0.0228			
0634398	0.59	0.0232			
0634403	0.60	0.0236	7		
0634410	0.61	0.0240			

EDP#	Size	Decimal Equiv.	Flute Length	Overall Length	Shank Diameter
	Dc		ℓ	L	Ds
0634426	0.62	0.0244	7	38	3
0634432	0.63	0.0248			
0634449	0.64	0.0252			
0634455	0.65	0.0256			
0634461	0.66	0.0260			
0634478	0.67	0.0264			
0634484	0.68	0.0268			
0634490	0.69	0.0272			
0634506	0.70	0.0276			
0634512	0.71	0.0280			
0634529	0.72	0.0283	9		
0634535	0.73	0.0287			
0634541	0.74	0.0291			
0634558	0.75	0.0295			
0634564	0.76	0.0299			
0634570	0.77	0.0303			
0634587	0.78	0.0307			
0634593	0.79	0.0311			
0634609	0.80	0.0315			
0634615	0.81	0.0319			
0634621	0.82	0.0323			
0634638	0.83	0.0327			
0634644	0.84	0.0331			
0634650	0.85	0.0335			
0634667	0.86	0.0339			
0634673	0.87	0.0343			
0634680	0.88	0.0346			
0634696	0.89	0.0350			
0634701	0.90	0.0354	11		
0634718	0.91	0.0358			
0634724	0.92	0.0362			
0634730	0.93	0.0366			
0634747	0.94	0.0370			
0634753	0.95	0.0374			
0634760	0.96	0.0378			
0634776	0.97	0.0382			
0634782	0.98	0.0386			
0634799	0.99	0.0390			
0634804	1.00	0.0394	12		
0634810	1.01	0.0398			
0634827	1.02	0.0402			
0634833	1.03	0.0406			

HIGH PERFORMANCE DRILLS

EDP#	Size	Decimal Equiv.	Flute Length	Overall Length	Shank Diameter
	Dc		ℓ	L	Ds
0634840	1.04	0.0409	12	38	3
0634856	1.05	0.0413			
0634862	1.06	0.0417			
0634879	1.07	0.0421			
0634885	1.08	0.0425			
0634891	1.09	0.0429			
0634907	1.10	0.0433	14	47	
0634913	1.11	0.0437			
0634920	1.12	0.0441			
0634936	1.13	0.0445			
0634942	1.14	0.0449			
0634959	1.15	0.0453			
0634965	1.16	0.0457			
0634971	1.17	0.0461			
0634988	1.18	0.0465			
0634994	1.19	0.0469			
0635009	1.20	0.0472	15	47	
0635015	1.21	0.0476			
0635021	1.22	0.0480			
0635038	1.23	0.0484			
0635044	1.24	0.0488			
0635050	1.25	0.0492			
0635067	1.26	0.0496			
0635073	1.27	0.0500			
0635080	1.28	0.0504			
0635096	1.29	0.0508			
0635101	1.30	0.0512			
0635118	1.31	0.0516			
0635124	1.32	0.0520			
0635130	1.33	0.0524			
0635147	1.34	0.0528			
0635153	1.35	0.0531			
0635160	1.36	0.0535			
0635176	1.37	0.0539			
0635182	1.38	0.0543			
0635199	1.39	0.0547			
0635204	1.40	0.0551			
0635210	1.41	0.0555			
0635227	1.42	0.0559			
0635233	1.43	0.0563			
0635240	1.44	0.0567			
0635256	1.45	0.0571			
0635262	1.46	0.0575			
0635279	1.47	0.0579			
0635285	1.48	0.0583			
0635291	1.49	0.0587			
0635307	1.50	0.0591			
0635313	1.51	0.0594			
0635320	1.52	0.0598			

EDP#	Size	Decimal Equiv.	Flute Length	Overall Length	Shank Diameter
	Dc		ℓ	L	Ds
0635336	1.53	0.0602	15	47	3
0635342	1.54	0.0606			
0635359	1.55	0.0610			
0635365	1.56	0.0614			
0635371	1.57	0.0618			
0635388	1.58	0.0622			
0635394	1.59	0.0626			
0635400	1.60	0.0630			
0635416	1.61	0.0634			
0635422	1.62	0.0638			
0635439	1.63	0.0642			
0635445	1.64	0.0646			
0635451	1.65	0.0650			
0635468	1.66	0.0654			
0635474	1.67	0.0657			
0635480	1.68	0.0661			
0635497	1.69	0.0665			
0635502	1.70	0.0669			
0635519	1.71	0.0673			
0635525	1.72	0.0677			
0635531	1.73	0.0681			
0635548	1.74	0.0685			
0635554	1.75	0.0689			
0635560	1.76	0.0693			
0635577	1.77	0.0697			
0635583	1.78	0.0701			
0635590	1.79	0.0705			
0635605	1.80	0.0709			
0635611	1.81	0.0713			
0635628	1.82	0.0717			
0635634	1.83	0.0720			
0635640	1.84	0.0724			
0635657	1.85	0.0728			
0635663	1.86	0.0732			
0635670	1.87	0.0736			
0635686	1.88	0.0740			
0635692	1.89	0.0744			
0635708	1.90	0.0748			
0635714	1.91	0.0752			
0635720	1.92	0.0756			
0635737	1.93	0.0760			
0635743	1.94	0.0764			
0635750	1.95	0.0768			
0635766	1.96	0.0772			
0635772	1.97	0.0776			
0635789	1.98	0.0780			
0635795	1.99	0.0783			

1 per tube

⚠ WARNING: Cancer - www.P65Warnings.ca.gov

CARBIDE DRILLS

Standard Cutting Conditions

LIST 9544 AQMD

CARBIDE DRILLS

Work Material	"Carbon Steel, Cast Iron (200 HB)"			"Alloy Steel (20 - 30 HRC)"			"Mold Steel (30 - 40 HRC)"			"Hardened Steel (40 - 50 HRC)"			"Hardened Steel (50 - 55 HRC)"			Ductile Cast Iron			Stainless Steels					
	Drill Diameter (mm)	RPM	Feed (IPR)	Peck Increment (mm)	RPM	Feed (IPR)	Peck Increment (mm)	RPM	Feed (IPR)	Peck Increment (mm)	RPM	Feed (IPR)	Peck Increment (mm)	RPM	Feed (IPR)	Peck Increment (mm)	RPM	Feed (IPR)	Peck Increment (mm)	RPM	Feed (IPR)	Peck Increment (mm)		
0.2	31800	0.0001	0.1D	26500	0.0001	0.1D	21200	0.0001	0.1D	12700	0.0001	0.1D	10600	0.0001	0.1D	31800	0.0001	0.1D	10600	0.0001	0.1D	10600	0.0001	0.1D
0.3	31800	0.0001		26500	0.0001		21200	0.0001		12700	0.0001		10600	0.0001		31800	0.0001		10600	0.0001				
0.4	31800	0.0002		25900	0.0002		19900	0.0002		12700	0.0002		9900	0.0002		31800	0.0002		9500	0.0002				
0.5	31800	0.0002		25900	0.0002		19100	0.0002		12700	0.0002		9200	0.0002		31800	0.0002		9500	0.0002				
1	23900	0.0006	0.2D	15900	0.0006	0.2D	12700	0.0006	0.2D	8000	0.0005	0.2D	5600	0.0004	0.2D	19100	0.0006	0.2D	5600	0.0006	0.2D	5600	0.0006	0.2D
1.5	21200	0.0011		13800	0.0011		9500	0.0011		6400	0.0009		4200	0.0006		17000	0.0011		4200	0.0012				
1.99	19200	0.0019		12800	0.0020		8000	0.0020		5600	0.0015		3600	0.0008		16000	0.0014		3600	0.0015				

Cutting Condition Table Recommendations

- 1) Adjust cutting condition according to the rigidity of the machine and work holding.
- 2) If the machine you are using has rotation limitations, reduce the rotation and feed rate by the same ratio.
- 3) Wet condition refers to drilling with water soluble coolant.
- 4) In non-water soluble coolant, reduce the rotation and feed rate by 20%.
- 5) Please use pecking regardless of the hole depth.
- 6) Retract plane for pecking should return to the top of the hole.
- 7) Drill runout should be 0.005mm or less.
- 8) Direct flood coolant along the work piece and not directly at the drill.

HIGH PERFORMANCE DRILLS

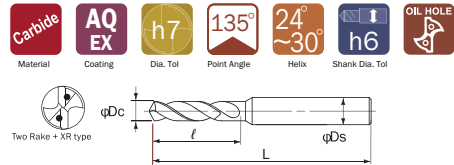

Aqua Drill EX Oil Hole Micro 3D



LIST 9604 Metric sizes

EDP#	Size	Decimal Equiv.	Flute Length	Overall Length	Shank Diameter
	Dc		ℓ	L	Ds
0754470	1.0	0.0394	6	54	3
0754492	1.1	0.0433	7	55	
0754514	1.2	0.0472	8		
0754537	1.3	0.0512	8	63	
0754550	1.4	0.0551	9		
0754572	1.5	0.0591	10	11	
0754595	1.6	0.0630	12		
0754617	1.7	0.0669		13	
0754630	1.8	0.0709	14		
0754652	1.9	0.0748		15	
0754675	2.0	0.0787	16		
0754698	2.1	0.0827		17.5	
0754710	2.2	0.0866	17.5		
0754732	2.3	0.0906		17.5	
0754755	2.4	0.0945	17.5		
0754778	2.5	0.0984		17.5	
0754790	2.6	0.1024	17.5		
0754812	2.7	0.1063		17.5	
0754835	2.8	0.1102	17.5		
0754858	2.9	0.1142		17.5	

1 per tube

⚠ WARNING: Cancer - www.P65Warnings.ca.gov

Aqua Drill EX Oil Hole Micro 5D



LIST 9606 Metric sizes

EDP#	Size	Decimal Equiv.	Flute Length	Overall Length	Shank Diameter
	Dc		ℓ	L	Ds
0737203	1.0	0.0394	8	56	3
0737210	1.1	0.0433	9	58	
0737226	1.2	0.0472	10		
0737232	1.3	0.0512	11	68	
0737249	1.4	0.0551	12		
0737255	1.5	0.0591	13	14	
0737261	1.6	0.0630	15		
0737278	1.7	0.0669		16	
0737284	1.8	0.0709	17		
0737290	1.9	0.0748		18	
0737306	2.0	0.0787	19		
0737312	2.1	0.0827		20	
0737329	2.2	0.0866	21		
0737335	2.3	0.0906		22	
0737341	2.4	0.0945	23		
0737358	2.5	0.0984		23	
0737364	2.6	0.1024	23		
0737370	2.7	0.1063		23	
0737387	2.8	0.1102	23		
0737393	2.9	0.1142		23	

1 per tube

⚠ WARNING: Cancer - www.P65Warnings.ca.gov

Drilling Conditions - Wet

LIST 9604, 9606

Work Material	Structural Steel Carbon Steel	Alloy Steel Heat Treated Steel (20 - 30 HRC)		Mold Steel Hardened Steel (30 - 40 HRC)		Hardened Steels (40 - 50 HRC)		Ductile Cast Iron		Stainless Steel (300 Series)		Nickel Alloys PH Stainless		Aluminum Alloy		
Speed (SFM)	160-200 SFM		140-180 SFM		130-165 SFM		95-115 SFM		130-165 SFM		90-115 SFM		30-50 SFM		255 - 310 SFM	
Drill Diameter Metric	RPM	Feed (IPR)	RPM	Feed (IPR)	RPM	Feed (IPR)	RPM	Feed (IPR)	RPM	Feed (IPR)	RPM	Feed (IPR)	RPM	Feed (IPR)	RPM	Feed (IPR)
1.0	15500	0.0009	13600	0.0008	12600	0.0006	9700	0.0005	12600	0.0008	9700	0.0005	3900	0.0004	24250	0.0005
1.5	10350	0.0013	9100	0.0012	8400	0.0009	6450	0.0007	8400	0.0012	6450	0.0007	2600	0.0006	16200	0.0008
2.0	7750	0.0017	6800	0.0016	6300	0.0012	4850	0.0009	6300	0.0016	4850	0.0010	1950	0.0008	12100	0.0012
2.5	6200	0.0024	5450	0.0021	5050	0.0013	3900	0.0012	5050	0.0021	3900	0.0015	1550	0.0012	9700	0.0022

Cutting Condition Table Recommendations

- 1) Adjust cutting condition according to the rigidity of machine or work clamp state.
- 2) The table values are for drilling with water-soluble cutting fluid.
- 3) Reduce RPM and feed rate by 30% for non-water soluble coolant.

HIGH PERFORMANCE DRILLS

DLC Drill



L9524 DLC Micro Range 0.5 to 1.9

L9520 DLC Regular Range 2.0 to 12.0

***JAPAN STOCK ITEM : Please allow 2-3 weeks delivery**

CARBIDE DRILLS

EDP#	Size	Decimal Equiv.	Flute Length	Overall Length	Shank Diameter
	Dc		ℓ	L	Ds
0626747	0.500	0.0197	6	44	3
0626753	0.600	0.0236	7		
0626760	0.700	0.0276	9		
0626776	0.800	0.0315	10		
0626782	0.900	0.0354	11		
0626799	1.000	0.0394	12		
0626804	1.100	0.0433	14	47	
0626810	1.200	0.0472	15		
0626827	1.300	0.0512			
0626833	1.400	0.0551			
0626840	1.500	0.0591			
0626856	1.600	0.0630			
0626862	1.700	0.0669			
0626879	1.800	0.0709			
0626885	1.900	0.0748			
0626346	2.000	0.0787			16
0626352	2.100	0.0827			
0626369	2.200	0.0866			
0626375	2.300	0.0906			
0626381	2.400	0.0945			
0626398	2.500	0.0984			
0626403	2.600	0.1024	17	49	
0626410	2.700	0.1063			
0626426	2.800	0.1102			
0626432	2.900	0.1142			
0626449	3.000	0.1181	19	51	
0626455	3.100	0.1220			
0626461	3.200	0.1260	21	53	
0626478	3.300	0.1299			
0626484	3.400	0.1339	24	56	
0626490	3.500	0.1378			
0626506	3.600	0.1417			
0626512	3.700	0.1457			
0626529	3.800	0.1496	27	59	
0626535	3.900	0.1535			
0626541	4.000	0.1575			
0626558	4.100	0.1614			
0626564	4.200	0.1654	31	71	
0626570	4.300	0.1693			
0626587	4.400	0.1732			
0626593	4.500	0.1772	33	75	
0626609	4.600	0.1811			
0626615	4.700	0.1850			
0626621	4.800	0.1890			
0626638	4.900	0.1929	38	77	
0626644	5.000	0.1969			
0626650	5.100	0.2008			
0626667	5.200	0.2047			
0626673	5.300	0.2087	41	82	
0626680	5.400	0.2126			
0626696	5.500	0.2165			
0626701	5.600	0.2205			
0626718	5.700	0.2244	41	85	
0626724	5.800	0.2283			
0626730	5.900	0.2323			
0625734	6.000	0.2362			
0625740	6.100	0.2402	41	85	
0625757	6.200	0.2441			
0625763	6.300	0.2480			
0625770	6.400	0.2520			
0625786	6.500	0.2559	41	85	

EDP#	Size	Decimal Equiv.	Flute Length	Overall Length	Shank Diameter
	Dc		ℓ	L	Ds
0625792	6.600	0.2598	43	87	8
0625808	6.700	0.2638			
0625814	6.800	0.2677			
0625820	6.900	0.2717			
0625837	7.000	0.2756			
0625843	7.100	0.2795			
0625850	7.200	0.2835	45	89	
0625866	7.300	0.2874			
0625872	7.400	0.2913			
0625889	7.500	0.2953			
0625895	7.600	0.2992	48	92	
0625900	7.700	0.3031			
0625917	7.800	0.3071			
0625923	7.900	0.3110			
0625930	8.000	0.3150	53	103	
0625946	8.100	0.3189			
0625952	8.200	0.3228			
0625969	8.300	0.3268			
0625975	8.400	0.3307			
0625981	8.500	0.3346			
0625998	8.600	0.3386	55	105	
0626002	8.700	0.3425			
0626019	8.800	0.3465			
0626025	8.900	0.3504			
0626031	9.000	0.3543	58	108	
0626048	9.100	0.3583			
0626054	9.200	0.3622			
0626060	9.300	0.3661			
0626077	9.400	0.3701	60	110	
0626083	9.500	0.3740			
0626090	9.600	0.3780			
0626105	9.700	0.3819			
0626111	9.800	0.3858	66	123	
0626128	9.900	0.3898			
0626134	10.000	0.3937			
0626140	10.100	0.3976			
0626157	10.200	0.4016	68	125	
0626163	10.300	0.4055			
0626170	10.400	0.4094			
0626186	10.500	0.4134			
0626192	10.600	0.4173	71	128	
0626208	10.700	0.4213			
0626214	10.800	0.4252			
0626220	10.900	0.4291			
0626237	11.000	0.4331	73	130	
0626243	11.100	0.4370			
0626250	11.200	0.4409			
0626266	11.300	0.4449			
0626272	11.400	0.4488	73	130	
0626289	11.500	0.4528			
0626295	11.600	0.4567			
0626300	11.700	0.4606			
0626317	11.800	0.4646	73	130	
0626323	11.900	0.4685			
0626330	12.000	0.4724			

1 per tube

⚠ WARNING: Cancer - www.P65Warnings.ca.gov

HIGH PERFORMANCE DRILLS

Standard Drilling Condition

L9524, L9520

Drilling in Wet & Semi Dry (Mist Coolant) Condition

Workpiece Material		Aluminum 1017		Aluminum Alloys						Aluminum Alloy Casting		Copper Alloys	
Speed (SFM)				4032, 6061		5052		7075					
Drill Diameter		650 - 820 SFM		330 - 500 SFM		500 - 650 SFM		500 - 650 SFM		430 - 590 SFM		260 - 330 SFM	
Metric mm	Decimal	RPM	Feed (IPR)	RPM	Feed (IPR)	RPM	Feed (IPR)	RPM	Feed (IPR)	RPM	Feed (IPR)	RPM	Feed (IPR)
0.5	0.0197	60,000	0.0002	58,000	0.0002	60,000	0.0002	60,000	0.0003	60,000	0.0003	38,000	0.0003
1	0.0394	50,000	0.0006	38,000	0.0006	50,000	0.0006	50,000	0.0007	48,000	0.0007	25,000	0.0007
2	0.0787	40,000	0.0014	24,000	0.0014	32,000	0.0015	32,000	0.0016	29,000	0.0016	16,000	0.0016
3	0.1181	26,500	0.0021	16,000	0.0021	21,000	0.0022	21,000	0.0024	19,000	0.0025	10,500	0.0024
5	0.1969	16,000	0.003	9,600	0.004	12,700	0.004	12,700	0.004	11,500	0.004	6,400	0.004
8	0.3150	10,000	0.006	6,000	0.006	8,000	0.006	8,000	0.006	7,200	0.007	4,000	0.006
10	0.3937	8,000	0.007	4,800	0.007	6,400	0.007	6,400	0.008	5,700	0.008	3,200	0.008
12	0.4724	6,600	0.008	4,000	0.008	5,300	0.009	5,300	0.010	4,800	0.010	2,650	0.010

Drilling in Dry Condition

Workpiece Material		Aluminum 1017		Aluminum Alloys						Aluminum Alloy Casting		Copper Alloys	
Speed (SFM)				4032, 6061		5052		7075					
Drill Diameter		--		210 - 260 SFM		280 - 330 SFM		330 - 390 SFM		280 - 330 SFM		164 - 196 SFM	
Metric mm	Decimal	RPM	Feed (IPR)	RPM	Feed (IPR)	RPM	Feed (IPR)	RPM	Feed (IPR)	RPM	Feed (IPR)	RPM	Feed (IPR)
0.5	0.0197	Not Used		30,000	0.0002	38,000	0.0002	45,000	0.0002	38,000	0.0002	22,000	0.0002
1	0.0394			20,000	0.0004	25,000	0.0004	30,000	0.0005	25,000	0.0005	15,000	0.0005
2	0.0787			12,500	0.0010	16,000	0.0010	19,000	0.0012	16,000	0.0012	9,500	0.0012
3	0.1181			8,500	0.0015	10,600	0.0016	12,700	0.0018	10,600	0.0018	6,400	0.0017
5	0.1969			5,100	0.0025	6,400	0.0026	7,600	0.003	6,400	0.003	3,800	0.003
8	0.3150			3,200	0.004	4,000	0.004	4,800	0.005	4,000	0.005	2,400	0.005
10	0.3937			2,550	0.005	3,200	0.005	3,800	0.006	3,200	0.006	1,900	0.006
12	0.4724			2,100	0.006	2,650	0.006	3,200	0.007	2,650	0.007	1,600	0.007

- 1) DLC Drills are used in Nonferrous Metals such as Aluminum or Copper Alloys.
- 2) Adjust drilling condition when unusual vibration or different sound occurs.
- 3) When using low speed machines, use the maximum speed and adjust the feed rate.

CARBIDE DRILLS

HIGH PERFORMANCE DRILLS

Aqua Drill EX Flat Stub

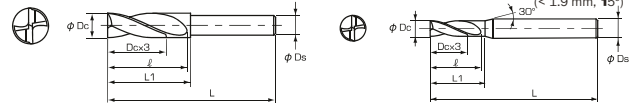

L9610 Metric Size
L9611 Fractional Size

CARBIDE DRILLS

List #	EDP #	Size	Decimal Equivalent	Flute Length	Overall Length	L1	Shank Dia.	Stock
		Dc		ℓ	L	L1	Ds	
L9610	0751974	0.2	0.0079	0.66	47	0.98	3	•
L9610	0751968	0.3	0.0118	0.99		1.36		•
L9610	0751951	0.4	0.0157	1.32		1.65		•
L9610	0737198	0.5	0.0197	1.65		2.03		•
L9610	0737181	0.6	0.0236	1.98		2.32		•
L9610	0737175	0.7	0.0276	2.31		2.71		•
L9610	0737169	0.8	0.0315	2.64		2.99		•
L9610	0737152	0.9	0.0354	2.97		3.28		•
L9610	0715148	1.0	0.0394	3.3		3.6		•
L9610	0715154	1.1	0.0433	3.5		3.9		•
L9610	0715160	1.2	0.0472	3.9	4.2	•		
L9610	0715177	1.3	0.0512	4.2	4.5	•		
L9610	0715183	1.4	0.0551	4.6	4.9	•		
L9610	0715190	1.5	0.0591	4.9	5.2	•		
L9610	0715205	1.6	0.0630	5.2	5.5	•		
L9610	0715211	1.7	0.0669	5.5	5.8	•		
L9610	0715228	1.8	0.0709	5.8	6.1	•		
L9610	0715234	1.9	0.0748	6.2	6.5	•		
L9610	0711354	2.0	0.0787	9	9.8	•		
L9610	0713180	2.1	0.0827		11.4	•		
L9610	0711360	2.2	0.0866	11	11.4	•		
L9610	0713197	2.3	0.0906		11.5	•		
L9610	0713202	2.4	0.0945		12.6	•		
L9610	0711377	2.5	0.0984	12	12.7	•		
L9610	0713219	2.6	0.1024		12.8	•		
L9610	0713225	2.7	0.1063		14.9	•		
L9610	0713231	2.8	0.1102	14	15.0	•		
L9610	0713248	2.9	0.1142		15.0	•		
L9610	0709920	3.0	0.1181		14.4	•		
L9610	0713254	3.1	0.1220		15.5	•		
L9611	1455595	1/8	0.1250	15	18	•		
L9610	0713260	3.2	0.1260		15.6	•		
L9610	0710839	3.3	0.1299		15.7	•		
L9610	0713277	3.4	0.1339		16.2	•		
L9610	0709936	3.5	0.1378	16	16.3	•		
L9610	0713283	3.6	0.1417		16.4	•		
L9610	0713290	3.7	0.1457		18.0	•		
L9610	0713305	3.8	0.1496		18.1	•		
L9610	0713311	3.9	0.1535	18	18.2	•		
L9611	1455600	5/32	0.1563		20	•		
L9610	0709942	4.0	0.1575		18.3	•		
L9610	0713328	4.1	0.1614		20.4	•		
L9610	0710845	4.2	0.1654	19	20.4	•		
L9610	0713334	4.3	0.1693		20.5	•		
L9610	0713340	4.4	0.1732		22.6	•		
L9610	0709959	4.5	0.1772	21	22.7	•		
L9610	0713357	4.6	0.1811		22.8	•		
L9610	0713363	4.7	0.1850		22.9	•		
L9611	1455617	3/16	0.1875	22	24	•		
L9610	0713370	4.8	0.1890		23.0	•		
L9610	0713386	4.9	0.1929		23.0	•		
L9610	0709965	5.0	0.1969	23	23.1	•		
L9610	0713392	5.1	0.2008		26.2	•		
L9610	0713408	5.2	0.2047	24	26.3	•		
L9610	0711390	5.3	0.2087		26.4	•		
L9610	0713414	5.4	0.2126		27.5	•		
L9610	0709971	5.5	0.2165	25	27.6	•		
L9611	1455623	7/32	0.2188		28	•		
L9610	0713420	5.6	0.2205		27.7	•		
L9610	0713437	5.7	0.2244		29.7	•		
L9610	0713443	5.8	0.2283	27	29.8	•		
L9610	0713450	5.9	0.2323		29.9	•		
L9610	0709988	6.0	0.2362		30	•		

List #	EDP #	Size	Decimal Equivalent	Flute Length	Overall Length	L1	Shank Dia.	Stock	
		Dc		ℓ	L	L1	Ds		
L9610	0713466	6.1	0.2402	28	70	31	6	•	
L9610	0713472	6.2	0.2441					•	
L9610	0713489	6.3	0.2480					•	
L9611	1455630	1/4	0.2500					•	
L9610	0713495	6.4	0.2520					•	
L9610	0709994	6.5	0.2559					•	
L9610	0713500	6.6	0.2598					•	
L9610	0713517	6.7	0.2638					•	
L9610	0710851	6.8	0.2677					•	
L9610	0713523	6.9	0.2717					•	
L9610	0710008	7.0	0.2756	32	•				
L9610	0713530	7.1	0.2795	33	36	6	•		
L9611	1455646	9/32	0.2812				•		
L9610	0713546	7.2	0.2835				•		
L9610	0713552	7.3	0.2874				•		
L9610	0713569	7.4	0.2913				•		
L9610	0710014	7.5	0.2953				34	•	
L9610	0713575	7.6	0.2992				•		
L9610	0713581	7.7	0.3031				•		
L9610	0713598	7.8	0.3071				•		
L9610	0713603	7.9	0.3110				36	39	•
L9611	1455652	5/16	0.3125	37	40	8	•		
L9610	0710020	8.0	0.3150				•		
L9610	0713610	8.1	0.3189				•		
L9610	0713626	8.2	0.3228				•		
L9610	0713632	8.3	0.3268				•		
L9611	1455669	21/64	0.3281				•		
L9610	0713649	8.4	0.3307				39	42	•
L9610	0710037	8.5	0.3346				•		
L9610	0713655	8.6	0.3386				•		
L9610	0713661	8.7	0.3425				40	•	
L9610	0711405	8.8	0.3465	41	45	8	•		
L9610	0713678	8.9	0.3504				•		
L9610	0710043	9.0	0.3543				42	•	
L9610	0713684	9.1	0.3583				•		
L9611	1455675	23/64	0.3594				•		
L9610	0713690	9.2	0.3622				•		
L9610	0713706	9.3	0.3661				43	•	
L9610	0713712	9.4	0.3701				•		
L9610	0710050	9.5	0.3740				•		
L9611	1455681	3/8	0.3750				•		
L9610	0713729	9.6	0.3780	45	48	8	•		
L9610	0713735	9.7	0.3819				•		
L9610	0713741	9.8	0.3858				•		
L9610	0713758	9.9	0.3898				•		
L9610	0710066	10.0	0.3937				•		
L9610	0713764	10.1	0.3976				•		
L9610	0713770	10.2	0.4016				46	49	•
L9610	0710868	10.3	0.4055				•		
L9611	1455698	13/32	0.4063				•		
L9610	0713787	10.4	0.4094				48	•	
L9610	0710072	10.5	0.4134	49	51	10	•		
L9610	0713793	10.6	0.4173				•		
L9610	0713809	10.7	0.4213				•		
L9610	0711411	10.8	0.4252				•		
L9610	0713815	10.9	0.4291				•		
L9610	0710089	11.0	0.4331				50	•	
L9610	0713821	11.1	0.4370				•		
L9611	1455703	7/16	0.4375				•		
L9610	0713838	11.2	0.4409				51	54	•
L9610	0713844	11.3	0.4449				•		
L9610	0713850	11.4	0.4488	•					
L9610	0710095	11.5	0.4528	52	•				

HIGH PERFORMANCE DRILLS

L9610 Metric Size

L9611 Fractional Size

List #	EDP #	Size	Decimal Equivalent	Flute Length ℓ	Overall Length L	L1 L1	Shank Dia. Ds	Stock
L9611	1455710	29/64	0.4531	52	90	54	10	•
L9610	0713867	11.6	0.4567					•
L9610	0713873	11.7	0.4606					•
L9610	0713880	11.8	0.4646					•
L9610	0713896	11.9	0.4685					•
L9611	1455726	15/32	0.4688					•
L9610	0710100	12.0	0.4724	54	57	10	•	
L9610	0724619	12.1	0.4764				•	
L9610	0724625	12.2	0.4803				•	
L9610	0724631	12.3	0.4843				•	
L9610	0724648	12.4	0.4882				•	
L9610	0710117	12.5	0.4921				•	
L9610	0724654	12.6	0.4961	57	60	12	•	
L9610	0724660	12.7	0.5000				•	
L9611	1455732	1/2	0.5000				•	
L9610	0724677	12.8	0.5039				•	
L9610	0724683	12.9	0.5079				•	
L9610	0710123	13.0	0.5118				•	
L9610	0724690	13.1	0.5157	59	63	12	•	
L9610	0724705	13.2	0.5197				•	
L9610	0724711	13.3	0.5236				•	
L9610	0724728	13.4	0.5276				•	
L9610	0710130	13.5	0.5315				•	
L9610	0724734	13.6	0.5354				•	
L9610	0724740	13.7	0.5394	61	66	20	•	
L9610	0724757	13.8	0.5433				•	
L9610	0724763	13.9	0.5472				•	
L9610	0710146	14.0	0.5512				•	
L9610	0724770	14.1	0.5551				•	
L9610	0724786	14.2	0.5591				•	

List #	EDP #	Size	Decimal Equivalent	Flute Length ℓ	Overall Length L	L1 L1	Shank Dia. Ds	Stock
L9611	1455749	9/16	0.5625	64	105	67	12	•
L9610	0724792	14.3	0.5630					•
L9610	0724808	14.4	0.5669					•
L9610	0710152	14.5	0.5709	66	105	69	•	
L9610	0724814	14.6	0.5748				•	
L9610	0724820	14.7	0.5787				•	
L9610	0724837	14.8	0.5827				•	
L9610	0724843	14.9	0.5866				•	
L9610	0710169	15.0	0.5906				•	
L9610	0724850	15.1	0.5945	68	115	72	•	
L9610	0724866	15.2	0.5984				•	
L9610	0724872	15.3	0.6024				•	
L9610	0724889	15.4	0.6063				•	
L9610	0710175	15.5	0.6102				•	
L9610	0724895	15.6	0.6142				•	
L9610	0724900	15.7	0.6181	70	115	75	•	
L9610	0724917	15.8	0.6220				•	
L9611	1455755	5/8	0.6250				•	
L9610	0724923	15.9	0.6260	72	125	81	•	
L9610	0710181	16.0	0.6299				•	
L9610	0710198	16.5	0.6496				•	
L9610	0710203	17.0	0.6693				•	
L9611	1455761	11/16	0.6875				•	
L9610	0710210	17.5	0.6890				•	
L9610	0710226	18.0	0.7087	81	135	87	•	
L9610	0710232	18.5	0.7283				•	
L9610	0710249	19.0	0.7480				•	
L9611	1455778	3/4	0.7500	87	145	90	•	
L9610	0710255	19.5	0.7677				•	
L9610	0710261	20.0	0.7874				•	

⚠ WARNING: Cancer - www.P65Warnings.ca.gov

CARBIDE DRILLS

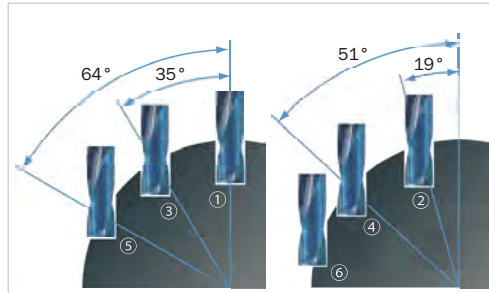

HIGH PERFORMANCE DRILLS

Aqua Drill EX Flat Radius

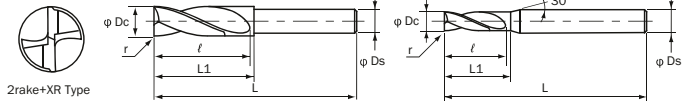

L9830 Metric Size
L9831 Fractional Size

CARBIDE DRILLS

List No.	EDP NO.	Size	Decimal Equivalent	Radius	FL	OAL	L1	Shank Dia.	Stock	List No.	EDP NO.	Size	Decimal Equivalent	Radius	FL	OAL	L1	Shank Dia.	Stock
		Dc		r	ℓ	L	L1	Ds				Dc		r	ℓ	L	L1	Ds	
9830	0732580	3.0	0.1181	0.3	14	50	16	6	•	9830	1490507	7.9	0.3110	0.4	36	70	39	8	•
9830	1490158	3.1	0.1220		15		17		•										
9831	1489960	1/8	0.1250		16		18		•										
9830	1490164	3.2	0.1260		17		19		•										
9830	0732597	3.3	0.1299		18		20		•										
9830	1490170	3.4	0.1339		19		21		•										
9830	0732602	3.5	0.1378		20		22		•										
9830	1490187	3.6	0.1417		21		23		•										
9830	1490193	3.7	0.1457		22		24		•										
9830	1490209	3.8	0.1496		23		25		•										
9830	1490215	3.9	0.1535	24	26	•													
9831	1489977	5/32	0.1563	25	27	•													
9830	0732619	4.0	0.1575	26	28	•													
9830	1490221	4.1	0.1614	27	29	•													
9830	0732625	4.2	0.1654	28	30	•													
9830	1490238	4.3	0.1693	29	31	•													
9830	1490244	4.4	0.1732	30	32	•													
9830	0732631	4.5	0.1772	31	33	•													
9830	1490250	4.6	0.1811	32	34	•													
9830	1490267	4.7	0.1850	33	35	•													
9831	1489983	3/16	0.1875	34	36	•													
9830	1490273	4.8	0.1890	35	37	•													
9830	1490280	4.9	0.1929	36	38	•													
9830	0732648	5.0	0.1969	37	39	•													
9830	1490296	5.1	0.2008	0.4	70	36	12	•	9831	1490122	9/16	0.5625	0.6	64	105	67	16	•	
9830	1490301	5.2	0.2047					38	40	•									
9830	0732654	5.3	0.2087					39	41	•									
9830	1490318	5.4	0.2126					40	42	•									
9830	0732660	5.5	0.2165					41	43	•									
9831	1489990	7/32	0.2188					42	44	•									
9830	1490324	5.6	0.2205					43	45	•									
9830	1490330	5.7	0.2244					44	46	•									
9830	1490347	5.8	0.2283					45	47	•									
9830	1490353	5.9	0.2323					46	48	•									
9830	0732677	6.0	0.2362	47	49	•													
9830	1490360	6.1	0.2402	48	50	•													
9830	1490376	6.2	0.2441	49	51	•													
9830	1490382	6.3	0.2480	50	52	•													
9831	1490003	1/4	0.2500	51	53	•													
9830	1490399	6.4	0.2520	52	54	•													
9830	0732683	6.5	0.2559	53	55	•													
9830	1490404	6.6	0.2598	54	56	•													
9830	1490410	6.7	0.2638	55	57	•													
9830	0732690	6.8	0.2677	56	58	•													
9830	1490427	6.9	0.2717	57	59	•													
9830	0732705	7.0	0.2756	58	60	•													
9830	1490433	7.1	0.2795	59	61	•													
9831	1490010	9/32	0.2812	60	62	•													
9830	1490440	7.2	0.2835	61	63	•													
9830	1490456	7.3	0.2874	62	64	•													
9830	1490462	7.4	0.2913	63	65	•													
9830	0732711	7.5	0.2953	64	66	•													
9830	1490479	7.6	0.2992	65	67	•													
9830	1490485	7.7	0.3031	66	68	•													
9830	1490491	7.8	0.3071	67	69	•													
9831	1490135	11/16	0.6875	68	70	•													
9831	1490141	3/4	0.7500	69	71	•													

⚠ WARNING: Cancer - www.P65Warnings.ca.gov

Drilling Conditions - Wet

LIST 9610, 9611, 9830, 9831

Work Material	Structural Steel Carbon Steel Cast Iron		Alloy Steel Heat Treated Steel (20 - 30 HRC)		Mold Steel Hardened Steel (30 - 40 HRC)		Ductile Cast Iron		Stainless Steel (300 Series)		Nickel Alloys PH Stainless		Aluminum Alloy		Aluminum Casting	
Speed (SFM)	65 - 150 SFM		60 - 140 SFM		40 - 110 SFM		60 - 140 SFM		55 - 85 SFM		50 - 75 SFM		80 - 190 SFM		70 - 175 SFM	
Drill Diameter Metric	RPM	Feed (IPR)	RPM	Feed (IPR)	RPM	Feed (IPR)	RPM	Feed (IPR)	RPM	Feed (IPR)	RPM	Feed (IPR)	RPM	Feed (IPR)	RPM	Feed (IPR)
0.2	31000	0.00008	28650	0.00006	19100	0.00004	28650	0.00005	26300	0.00006	24000	0.00006	38200	0.00016	33500	0.00008
0.5	16200	0.0002	15200	0.00015	11400	0.0001	15200	0.00012	14300	0.00015	12400	0.00015	19100	0.00040	17100	0.00020
1.0	13600	0.0004	12600	0.0003	9700	0.0002	12600	0.0002	7300	0.0003	6300	0.0003	17450	0.0008	16000	0.0004
1.5	9100	0.0006	8400	0.0005	6500	0.0004	8400	0.0004	4850	0.0005	4200	0.0005	11650	0.0012	10700	0.0007
2.0	6800	0.0009	6300	0.0008	4850	0.0007	6300	0.0007	3650	0.0008	3150	0.0008	8750	0.0014	8000	0.0009
Speed (SFM)	235 - 255 SFM		210 - 230 SFM		110 - 130 SFM		210 - 230 SFM		80 - 100 SFM		75 - 85 SFM		340 - 360 SFM		300-320 SFM	
3.0	7950	0.0020	6900	0.0020	3700	0.0020	6900	0.0015	2600	0.0020	2450	0.0018	11000	0.0025	9700	0.0020
4.0	5950	0.0025	5150	0.0025	2800	0.0025	5150	0.0025	1950	0.0023	1850	0.0020	8400	0.0030	7300	0.0025
5.0	4800	0.0035	4150	0.0035	2200	0.0030	4150	0.0030	1550	0.0026	1450	0.0022	6700	0.0040	5900	0.0035
6.0	4000	0.0040	3450	0.0040	1800	0.0035	3450	0.0035	1300	0.0031	1200	0.0026	5600	0.0045	4900	0.0040
8.0	3000	0.0055	2600	0.0055	1400	0.0050	2600	0.0045	970	0.0038	920	0.0032	4200	0.0065	3700	0.0055
10.0	2400	0.0070	2050	0.0070	1100	0.0060	2050	0.0060	780	0.0047	730	0.0039	3400	0.0080	3000	0.0070
12.0	2000	0.0085	1700	0.0085	950	0.0070	1700	0.0070	650	0.0057	610	0.0048	2800	0.0095	2500	0.0080
16.0	1500	0.0110	1300	0.0110	700	0.0095	1300	0.0095	550	0.0063	460	0.0057	2100	0.0125	1850	0.0110
20.0	1200	0.0140	1050	0.0135	550	0.0120	1050	0.0115	480	0.0066	370	0.0063	1700	0.0155	1500	0.0135

Cutting Condition Table Recommendations

- 1) Adjust cutting condition according to the rigidity of machine or work clamp state.
- 2) The table values are for drilling with water-soluble cutting fluid.
- 3) Reduce RPM and feed rate by 20% for non-water soluble coolant.

Reduction % to above table values				
Degree of Angle	Reduction %		Reduction % (Multiplier)	
	RPM	Feed	RPM	Feed
0° - 5°	100%	100%	Table Value	Table Value
6° - 20°	50%	50%	(Table Value)x0.5	(Table Value)x0.5
21 - 35°	70%	40%	(Table Value)x0.3	(Table Value)x0.6
36° - 60°	70%	40%	(Table Value)x0.3	(Table Value)x0.6
61° and above	70%	30%	(Table Value)x0.3	(Table Value)x0.7

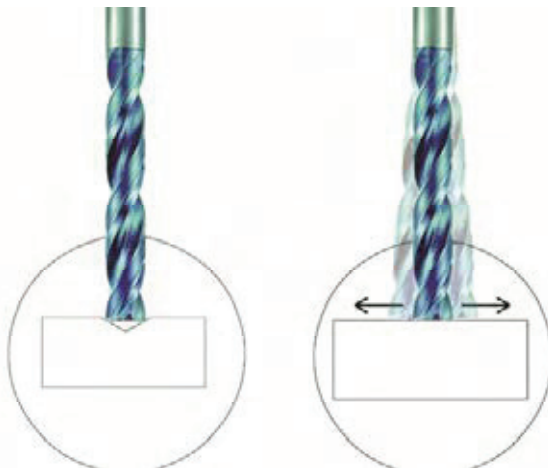

The longer a drill is, the higher the chance that it will walk. Flat bottom drills have a true 180° point. When entering on a flat surface, this amount of surface contact can cause the drill to walk. If this occurs, using a spot drill prior to the flat bottom drill will help to alleviate some of the surface contact to allow the drill to start properly.

HIGH PERFORMANCE DRILLS

Aqua Drill EX Flat Jobber Length



L9818 Metric Size
L9819 Fractional Size

• For entry on flat surfaces, Center Drill Hole is recommended

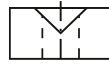

• Center Hole Diameter should be 0.5mm larger than Flat Drill Diameter

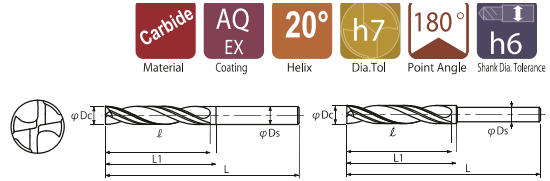

CARBIDE DRILLS

List #	EDP #	Size	Decimal Equivalent	Flute Length ℓ	Overall Length L	L1	Shank Dia. Ds	Stock	
L9818	0720751	3.0	0.1181	19	60	20	6	•	
L9818	0720768	3.1	0.1220	21		23		•	
L9819	1489249	1/8	0.1250			23		•	
L9818	0720774	3.2	0.1260	23		24		•	
L9818	0720780	3.3	0.1299			24		•	
L9818	0720797	3.4	0.1339	25		25		•	
L9818	0720802	3.5	0.1378			25		•	
L9818	0720819	3.6	0.1417	25		25		•	
L9818	0720825	3.7	0.1457			25		•	
L9818	0720831	3.8	0.1496	25		25		•	
L9818	0720848	3.9	0.1535		25	•			
L9819	1489255	5/32	0.1563	70	6	6	•		
L9818	0720854	4.0	0.1575				27	29	•
L9818	0720860	4.1	0.1614					29	•
L9818	0720877	4.2	0.1654				27	30	•
L9818	0720883	4.3	0.1693					30	•
L9818	0720890	4.4	0.1732				29	32	•
L9818	0720905	4.5	0.1772					32	•
L9818	0720911	4.6	0.1811				31	33	•
L9818	0720928	4.7	0.1850					33	•
L9819	1489261	3/16	0.1875				31	32	•
L9818	0720934	4.8	0.1890	32	•				
L9818	0720940	4.9	0.1929	32	36	•			
L9818	0720957	5.0	0.1969		36	•			
L9818	0720963	5.1	0.2008	34	37	•			
L9818	0720970	5.2	0.2047		37	•			
L9818	0720986	5.3	0.2087	36	39	•			
L9818	0720992	5.4	0.2126		39	•			
L9818	0721007	5.5	0.2165	38	41	•			
L9819	1489278	7/32	0.2188		41	•			
L9818	0721013	5.6	0.2205	40	43	•			
L9818	0721020	5.7	0.2244		43	•			
L9818	0721036	5.8	0.2283	42	45	•			
L9818	0721042	5.9	0.2323		45	•			
L9818	0721059	6.0	0.2362	44	47	•			
L9818	0721065	6.1	0.2402		47	•			
L9818	0721071	6.2	0.2441	46	49	•			
L9818	0721088	6.3	0.2480		49	•			
L9819	1489284	1/4	0.2500	48	52	•			
L9818	0721094	6.4	0.2520		52	•			
L9818	0721100	6.5	0.2559	48	53	•			
L9818	0721116	6.6	0.2598		53	•			
L9818	0721122	6.7	0.2638	51	55	•			
L9818	0721139	6.8	0.2677		55	•			
L9818	0721145	6.9	0.2717	51	55	•			
L9818	0721151	7.0	0.2756		55	•			
L9818	0721168	7.1	0.2795	52	55	•			
L9819	1489290	9/32	0.2812		55	•			
L9818	0721174	7.2	0.2835	52	55	•			
L9818	0721180	7.3	0.2874		55	•			
L9818	0721197	7.4	0.2913	52	55	•			
L9818	0721202	7.5	0.2953		55	•			
L9818	0721219	7.6	0.2992	52	55	•			
L9818	0721225	7.7	0.3031		55	•			
L9818	0721231	7.8	0.3071	52	55	•			
L9818	0721248	7.9	0.3110		55	•			
L9819	1489306	5/16	0.3125	52	55	•			
L9818	0721254	8.0	0.3150		55	•			
L9818	0721260	8.1	0.3189	52	55	•			
L9818	0721277	8.2	0.3228		55	•			
L9818	0721283	8.3	0.3268	52	55	•			
L9819	1489312	21/64	0.3281		55	•			
L9818	0721290	8.4	0.3307	55	•				

* Package Qty: 1 per Tube Size

List #	EDP #	Size	Decimal Equivalent	Flute Length ℓ	Overall Length L	L1	Shank Dia. Ds	Stock
L9818	0721305	8.5	0.3346	54	100	55	8	•
L9818	0721311	8.6	0.3386	56		57		•
L9818	0721328	8.7	0.3425			57		•
L9818	0721334	8.8	0.3465	56		59		•
L9818	0721340	8.9	0.3504			59		•
L9818	0721357	9.0	0.3543	59		60		•
L9818	0721363	9.1	0.3583			60		•
L9819	1489329	23/64	0.3594	61		62		•
L9818	0721370	9.2	0.3622			62		•
L9818	0721386	9.3	0.3661	63		64		•
L9818	0721392	9.4	0.3701		64	•		
L9818	0721408	9.5	0.3740	63	65	•		
L9819	1489335	3/8	0.3750		65	•		
L9818	0721414	9.6	0.3780	65	66	•		
L9818	0721420	9.7	0.3819		66	•		
L9818	0721437	9.8	0.3858	67	68	•		
L9818	0721443	9.9	0.3898		68	•		
L9818	0721450	10.0	0.3937	67	70	•		
L9818	0721466	10.1	0.3976		70	•		
L9818	0721472	10.2	0.4016	69	71	•		
L9818	0721489	10.3	0.4055		71	•		
L9819	1489341	13/32	0.4063	71	72	•		
L9818	0721495	10.4	0.4094		72	•		
L9818	0721500	10.5	0.4134	73	74	•		
L9818	0721517	10.6	0.4173		74	•		
L9818	0721523	10.7	0.4213	76	77	•		
L9818	0721530	10.8	0.4252		77	•		
L9818	0721546	10.9	0.4291	80	78	•		
L9818	0721552	11.0	0.4331		78	•		
L9818	0721569	11.1	0.4370	81	81	•		
L9819	1489358	7/16	0.4375		81	•		
L9818	0721575	11.2	0.4409	82	83	•		
L9818	0721581	11.3	0.4449		83	•		
L9818	0721598	11.4	0.4488	86	87	•		
L9818	0721603	11.5	0.4528		87	•		
L9819	1489364	29/64	0.4531	88	89	•		
L9818	0721610	11.6	0.4567		89	•		
L9818	0721626	11.7	0.4606	90	91	•		
L9818	0721632	11.8	0.4646		91	•		
L9818	0721649	11.9	0.4685	92	93	•		
L9819	1489370	15/32	0.4688		93	•		
L9818	0721655	12.0	0.4724	92	96	•		
L9818	0721661	12.5	0.4921		96	•		
L9819	1489387	1/2	0.5000	92	99	•		
L9818	0721678	13.0	0.5118		99	•		
L9818	0721684	13.5	0.5315	98	102	•		
L9818	0721690	14.0	0.5512		102	•		
L9819	1489393	9/16	0.5625	98	104	•		
L9818	0721706	14.5	0.5709		104	•		
L9818	0721712	15.0	0.5906	101	106	•		
L9818	0721729	15.5	0.6102		106	•		
L9819	1489409	5/8	0.6250	101	109	•		
L9818	0721735	16.0	0.6299		109	•		
L9818	0721741	16.5	0.6496	108	112	•		
L9818	0721758	17.0	0.6693		112	•		
L9819	1489415	11/16	0.6875	108	114	•		
L9818	0721764	17.5	0.6890		114	•		
L9818	0721770	18.0	0.7087	111	119	•		
L9818	0721787	18.5	0.7283		119	•		
L9818	0721793	19.0	0.7480	113	121	•		
L9819	1489421	3/4	0.7500		121	•		
L9818	0721809	19.5	0.7677	113	125	•		
L9818	0721815	20.0	0.7874		125	•		

⚠ WARNING: Cancer - www.P65Warnings.ca.gov

HIGH PERFORMANCE DRILLS

Aqua Drill EX Flat Long Shank



For entry on flat surfaces, Center Drill Hole is recommended



Center Hole Diameter should be 0.5mm larger than Flat drill Diameter

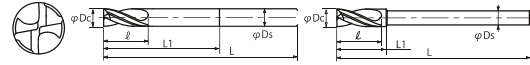

L9816 Metric Size
L9817 Fractional Size *Reach up to 10XD

List #	EDP #	Size	Decimal Equivalent	Flute Length ℓ	Overall Length L	L1	Shank Dia. Ds	Stock
L9816	0717701	3.0	0.1181	14	100	30	6	•
L9816	0717718	3.1	0.1220	15		31		•
L9817	1489438	1/8	0.1250			32		•
L9816	0717724	3.2	0.1260	32		•		
L9816	0717730	3.3	0.1299	16		33		•
L9816	0717747	3.4	0.1339			34		•
L9816	0717753	3.5	0.1378	18		35		•
L9816	0717760	3.6	0.1417			36		•
L9816	0717776	3.7	0.1457	19		37		•
L9816	0717782	3.8	0.1496			38		•
L9816	0717799	3.9	0.1535	21		39		•
L9817	1489444	5/32	0.1563			40		•
L9816	0717804	4.0	0.1575	22		40		•
L9816	0717810	4.1	0.1614			41		•
L9816	0717827	4.2	0.1654	23	42	•		
L9816	0717833	4.3	0.1693		43	•		
L9816	0717840	4.4	0.1732	24	44	•		
L9816	0717856	4.5	0.1772		45	•		
L9816	0717862	4.6	0.1811	25	46	•		
L9816	0717879	4.7	0.1850		47	•		
L9817	1489450	3/16	0.1875	26	48	•		
L9816	0717885	4.8	0.1890		48	•		
L9816	0717891	4.9	0.1929	27	49	•		
L9816	0717907	5.0	0.1969		50	•		
L9816	0717913	5.1	0.2008	28	51	•		
L9816	0717920	5.2	0.2047		52	•		
L9816	0717936	5.3	0.2087	29	53	•		
L9816	0717942	5.4	0.2126		54	•		
L9816	0717959	5.5	0.2165	30	55	•		
L9817	1489467	7/32	0.2188		56	•		
L9816	0717965	5.6	0.2205	31	56	•		
L9816	0717971	5.7	0.2244		57	•		
L9816	0717988	5.8	0.2283	32	58	•		
L9816	0717994	5.9	0.2323		59	•		
L9816	0718009	6.0	0.2362	33	60	•		
L9816	0718015	6.1	0.2402		30	•		
L9816	0718021	6.2	0.2441	34	32	•		
L9816	0718038	6.3	0.2480		32	•		
L9817	1489473	1/4	0.2500	35	32	•		
L9816	0718044	6.4	0.2520		32	•		
L9816	0718050	6.5	0.2559	36	32	•		
L9816	0718067	6.6	0.2598		32	•		
L9816	0718073	6.7	0.2638	37	33	•		
L9816	0718080	6.8	0.2677		33	•		
L9816	0718096	6.9	0.2717	38	34	•		
L9816	0718101	7.0	0.2756		34	•		
L9816	0718118	7.1	0.2795	39	35	•		
L9817	1489480	9/32	0.2812		35	•		
L9816	0718124	7.2	0.2835	40	35	•		
L9816	0718130	7.3	0.2874		35	•		
L9816	0718147	7.4	0.2913	41	36	•		
L9816	0718153	7.5	0.2953		36	•		
L9816	0718160	7.6	0.2992	42	36	•		
L9816	0718176	7.7	0.3031		36	•		
L9816	0718182	7.8	0.3071	43	38	•		
L9816	0718199	7.9	0.3110		38	•		
L9817	1489496	5/16	0.3125	44	80	•		
L9816	0718204	8.0	0.3150		80	•		
L9816	0718210	8.1	0.3189	45	39	•		
L9816	0718227	8.2	0.3228		39	•		
L9816	0718233	8.3	0.3268	46	39	•		
L9817	1489501	21/64	0.3281		39	•		
L9816	0718240	8.4	0.3307	39	•			

List #	EDP #	Size	Decimal Equivalent	Flute Length ℓ	Overall Length L	L1	Shank Dia. Ds	Stock
L9816	0718256	8.5	0.3346	39	130	41	8	•
L9816	0718262	8.6	0.3386			41		•
L9816	0718279	8.7	0.3425	40		42		•
L9816	0718285	8.8	0.3465			42		•
L9816	0718291	8.9	0.3504	41		43		•
L9816	0718307	9.0	0.3543			43		•
L9816	0718313	9.1	0.3583	42		44		•
L9817	1489518	23/64	0.3594			44		•
L9816	0718320	9.2	0.3622	43		45		•
L9816	0718336	9.3	0.3661			45		•
L9816	0718342	9.4	0.3701	44		47		•
L9816	0718359	9.5	0.3740			47		•
L9817	1489524	3/8	0.3750	45		47		•
L9816	0718365	9.6	0.3780			47		•
L9816	0718371	9.7	0.3819	46	100	•		
L9816	0718388	9.8	0.3858		48	•		
L9816	0718394	9.9	0.3898	47	48	•		
L9816	0718400	10.0	0.3937		48	•		
L9816	0718416	10.1	0.3976	48	50	•		
L9816	0718422	10.2	0.4016		50	•		
L9816	0718439	10.3	0.4055	49	51	•		
L9817	1489530	13/32	0.4063		51	•		
L9816	0718445	10.4	0.4094	50	52	•		
L9816	0718451	10.5	0.4134		52	•		
L9816	0718468	10.6	0.4173	51	53	•		
L9816	0718474	10.7	0.4213		53	•		
L9816	0718480	10.8	0.4252	52	54	•		
L9816	0718497	10.9	0.4291		54	•		
L9816	0718502	11.0	0.4331	53	56	•		
L9816	0718519	11.1	0.4370		56	•		
L9817	1489547	7/16	0.4375	54	120	•		
L9816	0718525	11.2	0.4409		57	•		
L9816	0718531	11.3	0.4449	55	170	•		
L9816	0718548	11.4	0.4488		58	•		
L9816	0718554	11.5	0.4528	56	180	•		
L9817	1489553	29/64	0.4531		59	•		
L9816	0718560	11.6	0.4567	57	61	•		
L9816	0718577	11.7	0.4606		61	•		
L9816	0718583	11.8	0.4646	58	63	•		
L9816	0718590	11.9	0.4685		63	•		
L9817	1489560	15/32	0.4688	59	65	•		
L9816	0718605	12.0	0.4724		65	•		
L9816	0718611	12.5	0.4921	60	66	•		
L9817	1489576	1/2	0.5000		66	•		
L9816	0718628	13.0	0.5118	61	68	•		
L9816	0718634	13.5	0.5315		68	•		
L9816	0718640	14.0	0.5512	62	69	•		
L9817	1489582	9/16	0.5625		69	•		
L9816	0718657	14.5	0.5709	63	72	•		
L9816	0718663	15.0	0.5906		72	•		
L9816	0718670	15.5	0.6102	64	74	•		
L9817	1489599	5/8	0.6250		74	•		
L9816	0718686	16.0	0.6299	65	160	•		
L9816	0718692	16.5	0.6496		75	•		
L9816	0718708	17.0	0.6693	66	200	•		
L9817	1489604	11/16	0.6875		77	•		
L9816	0718714	17.5	0.6890	67	81	•		
L9816	0718720	18.0	0.7087		81	•		
L9816	0718737	18.5	0.7283	68	83	•		
L9816	0718743	19.0	0.7480		83	•		
L9817	1489610	3/4	0.7500	69	86	•		
L9816	0718750	19.5	0.7677		86	•		
L9816	0718750	19.5	0.7677	70	88	•		
L9816	0718766	20.0	0.7874		88	•		
L9816	0718766	20.0	0.7874	90	•			

* Package Qty: 1 per Tube Size

⚠ WARNING: Cancer - www.P65Warnings.ca.gov

HIGH PERFORMANCE DRILLS

Standard Drilling Conditions

LIST 9818, 9819 - AQDEXZR

Work Material			Cast Irons / Carbon Steels		Alloy Steels (20-30 HRC)		Mold Steels/ Hardened Steels (30-35 HRC)		Ductile Cast Irons		Aluminum Alloys		Aluminum Casting	
Speed (SFM)			325-328 SFM		290-295 SFM		220-225 SFM		290-295 SFM		515-525 SFM		260-400 SFM	
Drill Diameter			325-328 SFM		290-295 SFM		220-225 SFM		290-295 SFM		515-525 SFM		260-400 SFM	
Metric	mm	Decimal	RPM	Feed (IPR)	RPM	Feed (IPR)	RPM	Feed (IPR)	RPM	Feed (IPR)	RPM	Feed (IPR)	RPM	Feed (IPR)
3	0.118		10600	0.002	9500	0.002	7400	0.002	9500	0.002	17000	0.002	12700	0.002
4	0.157		7900	0.003	7100	0.002	5550	0.002	7100	0.002	12500	0.002	9500	0.003
5	0.197		6300	0.004	5700	0.003	4450	0.003	5700	0.003	10000	0.003	7600	0.004
6	0.236		5300	0.005	4750	0.004	3700	0.004	4750	0.004	8500	0.003	6400	0.005
8	0.315		3950	0.006	3550	0.005	2790	0.005	3550	0.005	6350	0.005	4780	0.006
10	0.394		3150	0.008	2860	0.006	2230	0.006	2860	0.006	5100	0.006	3800	0.008
12	0.472		2650	0.009	2390	0.007	1860	0.007	2390	0.007	4250	0.007	3180	0.009
16	0.630		1990	0.012	1790	0.009	1390	0.009	1790	0.009	3200	0.009	2390	0.013
20	0.787		1590	0.016	1430	0.012	1110	0.012	1430	0.012	2550	0.012	1910	0.016

CARBIDE DRILLS

LIST 9816, 9817 - AQDEXZLS

Work Material			Cast Irons / Carbon Steels		Alloy Steels (20-30 HRC)		Mold Steels/ Hardened Steels (30-35 HRC)		Ductile Cast Irons		Aluminum Alloys		Aluminum Casting	
Speed (SFM)			325-328 SFM		290-295 SFM		220-225 SFM		290-295 SFM		515-525 SFM		260-400 SFM	
Drill Diameter			325-328 SFM		290-295 SFM		220-225 SFM		290-295 SFM		515-525 SFM		260-400 SFM	
Metric	mm	Decimal	RPM	Feed (IPR)	RPM	Feed (IPR)	RPM	Feed (IPR)	RPM	Feed (IPR)	RPM	Feed (IPR)	RPM	Feed (IPR)
3	0.118		10600	0.003	9500	0.002	7400	0.002	9500	0.002	17000	0.002	12700	0.002
4	0.157		7900	0.004	7100	0.003	5550	0.002	7100	0.003	12500	0.002	9500	0.003
5	0.197		6300	0.005	5700	0.004	4450	0.003	5700	0.004	10000	0.003	7600	0.004
6	0.236		5300	0.006	4750	0.005	3700	0.004	4750	0.005	8500	0.003	6400	0.005
8	0.315		3950	0.008	3550	0.006	2790	0.005	3550	0.006	6350	0.005	4780	0.006
10	0.394		3150	0.010	2860	0.008	2230	0.006	2860	0.008	5100	0.006	3800	0.008
12	0.472		2650	0.012	2390	0.009	1860	0.007	2390	0.009	4250	0.007	3180	0.009
16	0.630		1990	0.016	1790	0.013	1390	0.009	1790	0.013	3200	0.009	2390	0.013
20	0.787		1590	0.020	1430	0.016	1110	0.012	1430	0.016	2550	0.012	1910	0.016

- Note : 1) Adjust drilling conditions according to the rigidity of machine or work clamp state.
 2) Use the table values for drilling depths upto 2xD. Adjust cutting conditions per table based on "degree angle to be drilled."
 3) Above table values are for drilling water soluble cutting fluid. For non-water soluble cutting fluid reduce the RPM and feed rates by 20%.
 4) Not recommended for drilling in Stainless Steel. We recommend using List9814 AQUA EX Flat OH3Dor OH5D for Stainless Steel & Hi-temp alloys.
 5) Center Drill or Guide hole required. (1: Use AG Starting drill or Aqua Ex Flat drill)

Formulas : $RPM = \frac{SFM \times 3.82}{\text{Drill dia.}}$ Feed Rate (in/min) : $RPM \times IPR$

Drilling Conditions for Angled Surfaces					
Reduction % to above table values					
Degree Angle		Reduction %		Reduction % (Multiplier)	
		RPM	Feed	RPM	Feed
0°	5°	100%	100%	Table Value	Table Value
6°	20°	50%	50%	(Table Value)x0.5	(Table Value)x0.5
21°	35°	70%	40%	(Table Value)x0.3	(Table Value)x0.6
36°	60°	70%	40%	(Table Value)x0.3	(Table Value)x0.6
61°		70%	30%	(Table Value)x0.3	(Table Value)x0.7

HIGH PERFORMANCE DRILLS

Aqua Drill EX Flat Oil Hole 3D



Drill Dia (in mm)		Corner Chamfer
Above	Up to	C (mm)
	6.0	0.04
6.0	10.0	0.1
10.0		0.2

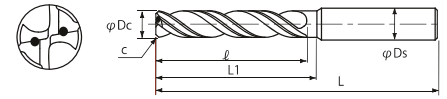

• For entry on flat surfaces, Center Drill Hole is recommended



• Center hole diameter should be 75% of flat drill diameter, or larger.

L9812 Metric Sizes
L9813 Fractional Size

List #	EDP #	Size	Decimal Equivalent	Flute Length	Overall Length	L1	Shank Dia.	Stock
L9812	0760322	1.0	0.0394	4.3	55	4.6		•
L9812	0760339	1.1	0.0433	4.7		5		•
L9812	0760345	1.2	0.0472	5.2		5.5		•
L9812	0760351	1.3	0.0512	5.6		5.9		•
L9812	0760368	1.4	0.0551	6		6.3		•
L9812	0760374	1.5	0.0591	6.5		6.8		•
L9812	0760380	1.6	0.0630	6.9		7.2		•
L9812	0760397	1.7	0.0669	7.3		7.6		•
L9812	0760402	1.8	0.0709	7.7		8		•
L9812	0760419	1.9	0.0748	8.2		8.5		•
L9812	0760425	2.0	0.0787	8.6		8.9		•
L9812	0760431	2.1	0.0827	9		9.3		•
L9812	0760448	2.2	0.0866	9.5		9.8		•
L9812	0760454	2.3	0.0906	9.9		10.2		•
L9812	0760460	2.4	0.0945	10.3		10.6		•
L9812	0760477	2.5	0.0984	10.8		11.1		•
L9812	0760483	2.6	0.1024	11.2		11.5		•
L9812	0760490	2.7	0.1063	11.6		11.9		•
L9812	0760505	2.8	0.1102	12		12.3		•
L9812	0760511	2.9	0.1142	12.5		12.9		•
L9812	0718772	3.0	0.1181	14	68	15		•
L9812	0718789	3.1	0.1220					•
L9813	1489627	1/8	0.1250	15				•
L9812	0718795	3.2	0.1260					•
L9812	0718800	3.3	0.1299					•
L9812	0718817	3.4	0.1339					•
L9812	0718823	3.5	0.1378					•
L9812	0718830	3.6	0.1417					•
L9812	0718846	3.7	0.1457					•
L9812	0718852	3.8	0.1496					•
L9812	0718869	3.9	0.1535					•
L9813	1489633	5/32	0.1563					•
L9812	0718875	4.0	0.1575					•
L9812	0718881	4.1	0.1614					•
L9812	0718898	4.2	0.1654					•
L9812	0718903	4.3	0.1693					•
L9812	0718910	4.4	0.1732					•
L9812	0718926	4.5	0.1772					•
L9812	0718932	4.6	0.1811					•
L9812	0718949	4.7	0.1850					•
L9813	1489640	3/16	0.1875					•
L9812	0718955	4.8	0.1890					•
L9812	0718961	4.9	0.1929					•
L9812	0718978	5.0	0.1969					•
L9812	0718984	5.1	0.2008					•
L9812	0718990	5.2	0.2047					•
L9812	0719005	5.3	0.2087					•
L9812	0719011	5.4	0.2126					•
L9812	0719028	5.5	0.2165					•
L9813	1489656	7/32	0.2188					•
L9812	0719034	5.6	0.2205					•
L9812	0719040	5.7	0.2244					•
L9812	0719057	5.8	0.2283					•
L9812	0719063	5.9	0.2323					•

List #	EDP #	Size	Decimal Equivalent	Flute Length	Overall Length	L1	Shank Dia.	Stock
L9812	0719070	6.0	0.2362	27	82	28	6	•
L9812	0719086	6.1	0.2402					•
L9812	0719092	6.2	0.2441	28				•
L9812	0719108	6.3	0.2480					•
L9813	1489662	1/4	0.2500					•
L9812	0719114	6.4	0.2520					•
L9812	0719120	6.5	0.2559					•
L9812	0719137	6.6	0.2598					•
L9812	0719143	6.7	0.2638					•
L9812	0719150	6.8	0.2677					•
L9812	0719166	6.9	0.2717					•
L9812	0719172	7.0	0.2756					•
L9812	0719189	7.1	0.2795					•
L9813	1489679	9/32	0.2812					•
L9812	0719195	7.2	0.2835					•
L9812	0719200	7.3	0.2874					•
L9812	0719217	7.4	0.2913					•
L9812	0719223	7.5	0.2953					•
L9812	0719230	7.6	0.2992					•
L9812	0719246	7.7	0.3031					•
L9812	0719252	7.8	0.3071					•
L9812	0719269	7.9	0.3110					•
L9813	1489685	5/16	0.3125					•
L9812	0719275	8.0	0.3150					•
L9812	0719281	8.1	0.3189					•
L9812	0719298	8.2	0.3228					•
L9812	0719303	8.3	0.3268					•
L9813	1489691	21/64	0.3281					•
L9812	0719310	8.4	0.3307					•
L9812	0719326	8.5	0.3346					•
L9812	0719332	8.6	0.3386					•
L9812	0719349	8.7	0.3425					•
L9812	0719355	8.8	0.3465					•
L9812	0719361	8.9	0.3504					•
L9812	0719378	9.0	0.3543					•
L9812	0719384	9.1	0.3583					•
L9813	1489707	23/64	0.3594					•
L9812	0719390	9.2	0.3622					•
L9812	0719406	9.3	0.3661					•
L9812	0719412	9.4	0.3701					•
L9812	0719429	9.5	0.3740					•
L9813	1489713	3/8	0.3750					•
L9812	0719435	9.6	0.3780					•
L9812	0719441	9.7	0.3819					•
L9812	0719458	9.8	0.3858					•
L9812	0719464	9.9	0.3898					•
L9812	0719470	10.0	0.3937					•
L9812	0719487	10.1	0.3976					•
L9812	0719493	10.2	0.4016					•
L9812	0719509	10.3	0.4055					•
L9813	1489720	13/32	0.4063					•
L9812	0719515	10.4	0.4094					•
L9812	0719521	10.5	0.4134					•
L9812	0719538	10.6	0.4173					•

* Package Qty: 1 per Tube Size

CARBIDE DRILLS

HIGH PERFORMANCE DRILLS

L9812 Metric Size
L9813 Fractional Size

CARBIDE DRILLS

List #	EDP #	Size	Decimal Equivalent	Flute Length ℓ	Overall Length L	L1	Shank Dia. Ds	Stock
L9812	0719544	10.7	0.4213	49	116	51	11	•
L9812	0719550	10.8	0.4252					•
L9812	0719567	10.9	0.4291					•
L9812	0719573	11.0	0.4331	50	122	53	12	•
L9812	0719580	11.1	0.4370					•
L9813	1489736	7/16	0.4375	51	122	53	12	•
L9812	0719596	11.2	0.4409					•
L9812	0719601	11.3	0.4449	52	122	54	12	•
L9812	0719618	11.4	0.4488					•
L9812	0719624	11.5	0.4528					•
L9813	1489742	29/64	0.4531	54	122	55	12	•
L9812	0719630	11.6	0.4567					•
L9812	0719647	11.7	0.4606	54	122	55	12	•
L9812	0719653	11.8	0.4646					•
L9812	0719660	11.9	0.4685					•

List #	EDP #	Size	Decimal Equivalent	Flute Length ℓ	Overall Length L	L1	Shank Dia. Ds	Stock
L9813	1489759	15/32	0.4688	54	122	55	12	•
L9812	0719676	12.0	0.4724					•
L9812	0719682	12.5	0.4921	57	128	59	13	•
L9813	1489765	1/2	0.5000					•
L9812	0719699	13.0	0.5118	61	134	63	14	•
L9812	0719704	13.5	0.5315					•
L9812	0719710	14.0	0.5512	63	140	68	15	•
L9813	1489771	9/16	0.5625					•
L9812	0719727	14.5	0.5709	66	140	69	16	•
L9812	0719733	15.0	0.5906					•
L9812	0719740	15.5	0.6102	70	146	72	17	•
L9813	1489788	5/8	0.6250					•
L9812	0719756	16.0	0.6299	72	146	73	18	•
L9813	1496964	11/16	0.6875					•
L9813	1496970	3/4	0.7500	76	152	77	20	•

* Package Qty: 1 per Tube Size

⚠ WARNING: Cancer - www.P65Warnings.ca.gov

Drilling Conditions - Wet

LIST 9812, 9813

Work Material	Structural Steel Carbon Steel	Alloy Steel Heat Treated Steel (20 - 30 HRC)	Mild Steel Hardened Steel (30 - 40 HRC)	Hardened Steels (40 - 50 HRC)	Ductile Cast Iron	Stainless Steel (300 Series)	Nickel Alloys PH Stainless	Aluminum Alloy	Aluminum Casting										
Speed (SFM)	160-200 SFM	130 - 170 SFM	100 - 140 SFM	80 - 100 SFM	130-165 SFM	90-115 SFM	70 - 80 SFM	180 - 200 SFM	160 - 185 SFM										
Drill Diameter	RPM	Feed (IPR)	RPM	Feed (IPR)	RPM	Feed (IPR)	RPM	Feed (IPR)	RPM	Feed (IPR)	RPM	Feed (IPR)	RPM	Feed (IPR)	RPM	Feed (IPR)	RPM	Feed (IPR)	
	Metric	Dec. Inch																	
1.0	0.039	15500	0.0004	13600	0.0003	10700	0.0002	8700	0.0002	12600	0.0002	9700	0.0003	6800	0.0003	18300	0.0008	15500	0.0004
1.5	0.059	10350	0.0006	9100	0.0005	7100	0.0004	5800	0.0004	8400	0.0004	6450	0.0005	4500	0.0005	12300	0.0012	10350	0.0007
2.0	0.079	7750	0.0009	6800	0.0008	5350	0.0007	4350	0.0007	6300	0.0007	4850	0.0008	3400	0.0008	9200	0.0014	7750	0.0009
Speed (SFM)	320 - 370 SFM	250 - 310 SFM	225 - 245 SFM	145 - 165 SFM	250 - 310 SFM	115-145 SFM	80 - 100 SFM	380 - 420 SFM	320 - 360 SFM										
3.0	0.118	10000	0.0030	9700	0.0019	7600	0.0016	4600	0.0016	9700	0.0016	4200	0.0024	2750	0.0018	12200	0.0035	10500	0.0033
4.0	0.157	8250	0.0040	7500	0.0024	5700	0.0020	3800	0.0020	7500	0.0020	3150	0.0031	2050	0.0024	9200	0.0047	8000	0.0044
5.0	0.197	6600	0.0050	6000	0.0031	4550	0.0026	3000	0.0026	6000	0.0026	2550	0.0039	1650	0.0030	7400	0.0059	6400	0.0055
6.0	0.236	5500	0.0060	4850	0.0040	3800	0.0036	2500	0.0036	4850	0.0036	2100	0.0047	1400	0.0035	6200	0.0071	5350	0.0066
8.0	0.315	4300	0.0080	3650	0.0052	2850	0.0046	1900	0.0046	3650	0.0046	1600	0.0063	1050	0.0047	4600	0.0094	4000	0.0088
10.0	0.394	3400	0.0100	2900	0.0063	2300	0.0057	1500	0.0057	2900	0.0057	1300	0.0071	830	0.0051	3700	0.0118	3200	0.0110
12.0	0.472	2850	0.0120	2450	0.0070	1900	0.0065	1300	0.0065	2450	0.0065	1050	0.0085	690	0.0061	3100	0.0142	2700	0.0132
16.0	0.630	2150	0.0160	1850	0.0090	1450	0.0085	1000	0.0085	1850	0.0085	790	0.0113	520	0.0082	2300	0.0189	2000	0.0176

Cutting Condition Table Recommendations

- 1) Adjust cutting condition according to the rigidity of machine or work clamp state.
- 2) The table values are for drilling with water-soluble cutting fluid.
- 3) Reduce RPM and feed rate by 20% for non-water soluble coolant.
- 4) Use 9812 3xD for angled and irregular entries. See chart below.
- 5) Recommended feeds and speeds are starting points only and may require adjustment based on specific material, condition of equipment, and coolant condition.

9812 Drilling Conditions for Angled Surfaces				
Reduction % to above table values				
Degree of Angle	Reduction %		Reduction % (Multiplier)	
	RPM	Feed	RPM	Feed
0° - 5°	100%	100%	Table Value	Table Value
6° - 20°	50%	50%	(Table Value)x0.5	(Table Value)x0.5
21 - 35°	70%	40%	(Table Value)x0.3	(Table Value)x0.6
36° - 60°	70%	40%	(Table Value)x0.3	(Table Value)x0.6
61° and above	70%	30%	(Table Value)x0.3	(Table Value)x0.7

HIGH PERFORMANCE DRILLS

Aqua Drill EX Flat Oil Hole 5D

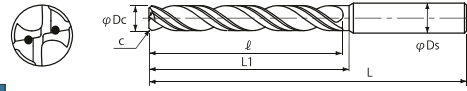

Drill Dia (in mm)		Corner Chamfer
Above	Up to	C (mm)
	6.0	0.04
6.0	10.0	0.1
10.0		0.2

L9814 Metric Sizes
L9815 Fractional Size

* For entry on flat surfaces, Center Drill Hole is recommended
* Center hole diameter should be 75% of flat drill diameter, or larger.

List #	EDP #	Size	Decimal Equivalent	Flute Length	Overall Length	L1	Shank Dia.	Stock
L9814	0760528	1.0	0.0394	6.3	57	6.6	3	•
L9814	0760534	1.1	0.0433	6.9		7.2		•
L9814	0760540	1.2	0.0472	7.6		7.9		•
L9814	0760557	1.3	0.0512	8.2		8.5		•
L9814	0760563	1.4	0.0551	8.8		9.1		•
L9814	0760570	1.5	0.0591	9.5		9.8		•
L9814	0760586	1.6	0.0630	10.1		10.4		•
L9814	0760592	1.7	0.0669	10.7		11		•
L9814	0760608	1.8	0.0709	11.3		11.6		•
L9814	0760614	1.9	0.0748	12		12.3		•
L9814	0760620	2.0	0.0787	12.6		12.9		•
L9814	0760637	2.1	0.0827	13.2		13.5		•
L9814	0760643	2.2	0.0866	13.9		14.2		•
L9814	0760650	2.3	0.0906	14.5		14.8		•
L9814	0760666	2.4	0.0945	15.1		15.4		•
L9814	0760672	2.5	0.0984	15.8		16.1		•
L9814	0760689	2.6	0.1024	16.4		16.7		•
L9814	0760695	2.7	0.1063	17		17.3		•
L9814	0760700	2.8	0.1102	17.6		17.9		•
L9814	0760717	2.9	0.1142	18.3		18.6		•
L9814	0719762	3.0	0.1181	20	74	21	•	
L9814	0719779	3.1	0.1220				•	
L9815	1489794	1/8	0.1250	22		25	•	
L9814	0719785	3.2	0.1260				•	
L9814	0719791	3.3	0.1299				•	
L9814	0719807	3.4	0.1339				•	
L9814	0719813	3.5	0.1378	24	80		4	•
L9814	0719820	3.6	0.1417				•	
L9814	0719836	3.7	0.1457				•	
L9814	0719842	3.8	0.1496			27	•	
L9814	0719859	3.9	0.1535				•	
L9815	1489800	5/32	0.1563	26			•	
L9814	0719865	4.0	0.1575				•	
L9814	0719871	4.1	0.1614				•	
L9814	0719888	4.2	0.1654	28		30	•	
L9814	0719894	4.3	0.1693				•	
L9814	0719900	4.4	0.1732				•	
L9814	0719916	4.5	0.1772	29		31	•	
L9814	0719922	4.6	0.1811		90		5	•
L9814	0719939	4.7	0.1850				•	
L9815	1489816	3/16	0.1875	32		34	•	
L9814	0719945	4.8	0.1890				•	
L9814	0719951	4.9	0.1929				•	
L9814	0719968	5.0	0.1969	33			•	
L9814	0719974	5.1	0.2008				•	
L9814	0719980	5.2	0.2047	35		38	•	
L9814	0719997	5.3	0.2087				•	
L9814	0720000	5.4	0.2126				•	
L9814	0720017	5.5	0.2165	37	94	39	6	•
L9815	1489822	7/32	0.2188				•	
L9814	0720023	5.6	0.2205				•	
L9814	0720030	5.7	0.2244				•	
L9814	0720046	5.8	0.2283	39		40	•	
L9814	0720052	5.9	0.2323				•	

List #	EDP #	Size	Decimal Equivalent	Flute Length	Overall Length	L1	Shank Dia.	Stock
L9814	0720069	6.0	0.2362	39	94		6	•
L9814	0720075	6.1	0.2402				•	
L9814	0720081	6.2	0.2441	41			•	
L9814	0720098	6.3	0.2480			44	•	
L9815	1489839	1/4	0.2500				•	
L9814	0720103	6.4	0.2520	43	101		7	•
L9814	0720110	6.5	0.2559			45	•	
L9814	0720126	6.6	0.2598				•	
L9814	0720132	6.7	0.2638				•	
L9814	0720149	6.8	0.2677	45		46	•	
L9814	0720155	6.9	0.2717				•	
L9814	0720161	7.0	0.2756	46			•	
L9814	0720178	7.1	0.2795				•	
L9815	1489845	9/32	0.2812	48			•	
L9814	0720184	7.2	0.2835			51	•	
L9814	0720190	7.3	0.2874				•	
L9814	0720206	7.4	0.2913				•	
L9814	0720212	7.5	0.2953	50	110	52	8	•
L9814	0720229	7.6	0.2992				•	
L9814	0720235	7.7	0.3031				•	
L9814	0720241	7.8	0.3071			53	•	
L9814	0720258	7.9	0.3110	52			•	
L9815	1489851	5/16	0.3125				•	
L9814	0720264	8.0	0.3150				•	
L9814	0720270	8.1	0.3189				•	
L9814	0720287	8.2	0.3228	54			•	
L9814	0720293	8.3	0.3268			57	•	
L9815	1489868	21/64	0.3281				•	
L9814	0720309	8.4	0.3307				•	
L9814	0720315	8.5	0.3346	56	117	58	9	•
L9814	0720321	8.6	0.3386				•	
L9814	0720338	8.7	0.3425				•	
L9814	0720344	8.8	0.3465	58		59	•	
L9814	0720350	8.9	0.3504				•	
L9814	0720367	9.0	0.3543	59			•	
L9814	0720373	9.1	0.3583			64	•	
L9815	1489874	23/64	0.3594	61		65	•	
L9814	0720380	9.2	0.3622				•	
L9814	0720396	9.3	0.3661			64	•	
L9814	0720401	9.4	0.3701				•	
L9814	0720418	9.5	0.3740	63	126	65	10	•
L9815	1489880	3/8	0.3750				•	
L9814	0720424	9.6	0.3780				•	
L9814	0720430	9.7	0.3819				•	
L9814	0720447	9.8	0.3858			66	•	
L9814	0720453	9.9	0.3898	65			•	
L9814	0720460	10.0	0.3937				•	
L9814	0720476	10.1	0.3976				•	
L9814	0720482	10.2	0.4016	67		70	•	
L9814	0720499	10.3	0.4055				•	
L9815	1489897	13/32	0.4063		138		11	•
L9814	0720504	10.4	0.4094				•	
L9814	0720510	10.5	0.4134	69		71	•	
L9814	0720527	10.6	0.4173				•	

* Package Qty: 1 per Tube Size

CARBIDE DRILLS

HIGH PERFORMANCE DRILLS

L9814 Metric Size
L9815 Fractional Size

CARBIDE DRILLS

List #	EDP #	Size	Decimal Equivalent	Flute Length	Overall Length	L1	Shank Dia.	Stock
L9814	0720533	Dc	0.4213	ℓ	L	L1	Ds	•
L9814	0720540	10.8	0.4252	72	138	73	11	•
L9814	0720556	10.9	0.4291	73	146	77	12	•
L9814	0720562	11.0	0.4331					•
L9814	0720579	11.1	0.4370	74	146	77	12	•
L9815	1489902	7/16	0.4375					•
L9814	0720585	11.2	0.4409					•
L9814	0720591	11.3	0.4449	76	146	78	12	•
L9814	0720607	11.4	0.4488					•
L9814	0720613	11.5	0.4528	76	146	79	12	•
L9815	1489919	29/64	0.4531					•
L9814	0720620	11.6	0.4567					•
L9814	0720636	11.7	0.4606	78	146	79	12	•
L9814	0720642	11.8	0.4646					•

List #	EDP #	Size	Decimal Equivalent	Flute Length	Overall Length	L1	Shank Dia.	Stock
L9814	0720659	Dc	0.4685	ℓ	L	L1	Ds	•
L9815	1489925	15/32	0.4688	78	146	79	12	•
L9814	0720665	12.0	0.4724	82	153	84	13	•
L9814	0720671	12.5	0.4921					•
L9815	1489931	1/2	0.5000	85	162	86	14	•
L9814	0720688	13.0	0.5118	86		86		•
L9814	0720694	13.5	0.5315	89	169	91	15	•
L9814	0720700	14.0	0.5512	91		92		•
L9815	1489948	9/16	0.5625	93	178	97	16	•
L9814	0720716	14.5	0.5709	95		97		•
L9814	0720722	15.0	0.5906	98	104	98	105	•
L9814	0720739	15.5	0.6102	102		104		•
L9815	1489954	5/8	0.6250	104	104	105	105	•
L9814	0720745	16.0	0.6299	104		105		•

* Package Qty: 1 per Tube Size

⚠ WARNING: Cancer - www.P65Warnings.ca.gov

Drilling Conditions - Wet

LIST 9814, 9815

Work Material		Structural Steel Carbon Steel	Alloy Steel Heat Treated Steel (20 - 30 HRC)		Mold Steel Hardened Steel (30 - 40 HRC)		Hardened Steels (40 - 50 HRC)		Ductile Cast Iron		Stainless Steel (300 Series)		Nickel Alloys PH Stainless		Aluminum Alloy		Aluminum Casting		
Speed (SFM)		160-200 SFM		130 - 170 SFM		100 - 140 SFM		80 - 100 SFM		130-165 SFM		90-115 SFM		70 - 80 SFM		180 - 200 SFM		160 - 185 SFM	
Drill Diameter	Metric	RPM	Feed (IPR)	RPM	Feed (IPR)	RPM	Feed (IPR)	RPM	Feed (IPR)	RPM	Feed (IPR)	RPM	Feed (IPR)	RPM	Feed (IPR)	RPM	Feed (IPR)	RPM	Feed (IPR)
1.0	0.039	15500	0.0004	13600	0.0003	10700	0.0002	8700	0.0002	12600	0.0002	9700	0.0003	6800	0.0003	18300	0.0008	15500	0.0004
1.5	0.059	10350	0.0006	9100	0.0005	7100	0.0004	5800	0.0004	8400	0.0004	6450	0.0005	4500	0.0005	12300	0.0012	10350	0.0007
2.0	0.079	7750	0.0009	6800	0.0008	5350	0.0007	4350	0.0007	6300	0.0007	4850	0.0008	3400	0.0008	9200	0.0014	7750	0.0009
Speed (SFM)		320 - 370 SFM		250 - 310 SFM		225 - 245 SFM		145 - 165 SFM		250 - 310 SFM		115-145 SFM		80 - 100 SFM		380 - 420 SFM		320 - 360 SFM	
3.0	0.118	10000	0.0030	9700	0.0019	7600	0.0016	4600	0.0016	9700	0.0016	4200	0.0024	2750	0.0018	12200	0.0035	10500	0.0033
4.0	0.157	8250	0.0040	7500	0.0024	5700	0.0020	3800	0.0020	7500	0.0020	3150	0.0031	2050	0.0024	9200	0.0047	8000	0.0044
5.0	0.197	6600	0.0050	6000	0.0031	4550	0.0026	3000	0.0023	6000	0.0026	2550	0.0039	1650	0.0028	7400	0.0059	6400	0.0055
6.0	0.236	5500	0.0060	4850	0.0040	3800	0.0032	2500	0.0030	4850	0.0036	2100	0.0044	1400	0.0033	6200	0.0071	5350	0.0066
8.0	0.315	4300	0.0080	3650	0.0052	2850	0.0042	1900	0.0040	3650	0.0046	1600	0.0059	1050	0.0045	4600	0.0094	4000	0.0088
10.0	0.394	3400	0.0100	2900	0.0063	2300	0.0053	1500	0.0050	2900	0.0057	1300	0.0067	830	0.0049	3700	0.0118	3200	0.0110
12.0	0.472	2850	0.0120	2450	0.0070	1900	0.0061	1300	0.0059	2450	0.0065	1050	0.0083	690	0.0059	3100	0.0142	2700	0.0132
16.0	0.630	2150	0.0160	1850	0.0090	1450	0.0081	1000	0.0078	1850	0.0085	790	0.0110	520	0.0076	2300	0.0189	2000	0.0176

Cutting Condition Table Recommendations

- 1) Adjust cutting condition according to the rigidity of machine or work clamp state.
- 2) The table values are for drilling with water-soluble cutting fluid.
- 3) Reduce RPM and feed rate by 20% for non-water soluble coolant.
- 4) For best results, use 9812 3xD for angled and irregular entries.
- 5) Recommended feeds and speeds are starting points only and may require adjustment based on specific material, condition of equipment, and coolant condition.

Drilling Conditions for Angled Surfaces				
Reduction % to above table values				
Degree of Angle	Reduction %		Reduction % (Multiplier)	
	RPM	Feed	RPM	Feed
0° - 5°	100%	100%	Table Value	Table Value
6° - 20°	50%	50%	(Table Value)x0.5	(Table Value)x0.5
21 - 35°	70%	40%	(Table Value)x0.3	(Table Value)x0.6
36° - 60°	70%	40%	(Table Value)x0.3	(Table Value)x0.6
61° and above	70%	30%	(Table Value)x0.3	(Table Value)x0.7

HIGH PERFORMANCE DRILLS

Aqua Drill EX Flat Super Stub

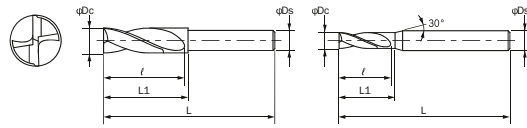

L9628

Metric Sizes

***JAPAN STOCK ITEM :**
Please allow 2-3 weeks delivery

List #	EDP #	Size	Decimal Equivalent	Flute Length	Overall Length	L1	Shank Dia.	Stock	
		Dc		ℓ	L	L1	Ds		
L9628	0765754	2.0	0.0787	7	50	7.8	4	•	
L9628	0765760	2.1	0.0827	8		8.4		8.4	•
L9628	0765777	2.2	0.0866			8.4		8.4	•
L9628	0765783	2.3	0.0906	9		8.5		9.6	•
L9628	0765790	2.4	0.0945			9.6		9.6	•
L9628	0765805	2.5	0.0984	10		9.7		9.8	•
L9628	0765811	2.6	0.1024			9.8		9.8	•
L9628	0765828	2.7	0.1063	11		10.9		10.9	•
L9628	0765834	2.8	0.1102			10.9		10.9	•
L9628	0765840	2.9	0.1142	12		11		11	•
L9628	0765055	3.0	0.1181			11		11	•
L9628	0765061	3.1	0.1220	13		12.5		12.5	•
L9628	0765078	3.2	0.1260			12.5		12.5	•
L9628	0765084	3.3	0.1299	14		12.6		12.6	•
L9628	0765090	3.4	0.1339		12.6	12.6	•		
L9628	0765106	3.5	0.1378	15	12.7	12.7	•		
L9628	0765112	3.6	0.1417		12.7	12.7	•		
L9628	0765129	3.7	0.1457	16	13.2	13.2	•		
L9628	0765135	3.8	0.1496		13.2	13.2	•		
L9628	0765141	3.9	0.1535	17	13.3	13.3	•		
L9628	0765158	4.0	0.1575		13.3	13.3	•		
L9628	0765164	4.1	0.1614	18	13.4	13.4	•		
L9628	0765170	4.2	0.1654		13.4	13.4	•		
L9628	0765187	4.3	0.1693	19	14	14	•		
L9628	0765193	4.4	0.1732		14	14	•		
L9628	0765209	4.5	0.1772	20	14.1	14.1	•		
L9628	0765215	4.6	0.1811		14.1	14.1	•		
L9628	0765221	4.7	0.1850	21	14.2	14.2	•		
L9628	0765238	4.8	0.1890		14.2	14.2	•		
L9628	0765244	4.9	0.1929	22	14.3	14.3	•		
L9628	0765250	5.0	0.1969		14.3	14.3	•		
L9628	0765267	5.1	0.2008	23	16.4	16.4	•		
L9628	0765273	5.2	0.2047		16.4	16.4	•		
L9628	0765280	5.3	0.2087	24	16.5	16.5	•		
L9628	0765296	5.4	0.2126		16.5	16.5	•		
L9628	0765301	5.5	0.2165	25	17.6	17.6	•		
L9628	0765318	5.6	0.2205		17.6	17.6	•		
L9628	0765324	5.7	0.2244	26	17.7	17.7	•		
L9628	0765330	5.8	0.2283		17.7	17.7	•		
L9628	0765347	5.9	0.2323	27	17.8	17.8	•		
L9628	0765353	6.0	0.2362		17.8	17.8	•		
L9628	0765360	6.1	0.2402	28	18.9	18.9	•		
L9628	0765376	6.2	0.2441		18.9	18.9	•		
L9628	0765382	6.3	0.2480	29	19	19	•		
L9628	0765399	6.4	0.2520		19	19	•		
L9628	0765404	6.5	0.2559	30	19.1	19.1	•		
L9628	0765410	6.6	0.2598		19.1	19.1	•		
L9628	0765427	6.7	0.2638	31	21.2	21.2	•		
L9628	0765433	6.8	0.2677		21.2	21.2	•		
L9628	0765440	6.9	0.2717	32	21.3	21.3	•		
L9628	0765456	7.0	0.2756		21.3	21.3	•		
L9628	0765462	7.1	0.2795	33	21.4	21.4	•		
L9628	0765479	7.2	0.2835		21.4	21.4	•		
L9628	0765485	7.3	0.2874	34	22.5	22.5	•		
L9628	0765491	7.4	0.2913		22.5	22.5	•		
L9628	0765507	7.5	0.2953	35	22.6	22.6	•		
L9628	0765513	7.6	0.2992		22.6	22.6	•		
L9628	0765520	7.7	0.3031	36	22.7	22.7	•		
L9628	0765536	7.8	0.3071		22.7	22.7	•		
L9628	0765542	7.9	0.3110	37	23.7	23.7	•		
L9628	0765559	8.0	0.3150		23.7	23.7	•		

List #	EDP #	Size	Decimal Equivalent	Flute Length	Overall Length	L1	Shank Dia.	Stock		
		Dc		ℓ	L	L1	Ds			
L9628	0765565	8.1	0.3189	29	80	8.1	8	•		
L9628	0765571	8.2	0.3228			8.2		8.2	•	
L9628	0765588	8.3	0.3268			30		33	33	•
L9628	0765594	8.4	0.3307							30
L9628	0765600	8.5	0.3346			31		34	34	•
L9628	0765616	8.6	0.3386							31
L9628	0765622	8.7	0.3425			32		35	35	•
L9628	0765639	8.8	0.3465							32
L9628	0765645	8.9	0.3504			33		36	36	•
L9628	0765651	9.0	0.3543							33
L9628	0765668	9.1	0.3583			34		37	37	•
L9628	0765674	9.2	0.3622							34
L9628	0765680	9.3	0.3661			35		38	38	•
L9628	0764690	9.4	0.3701							35
L9628	0764706	9.5	0.3740	36	39	39	•			
L9628	0764712	9.6	0.3780				36	36	•	
L9628	0764729	9.7	0.3819	37	40	40	•			
L9628	0764735	9.8	0.3858				37	37	•	
L9628	0764741	9.9	0.3898	38	41	41	•			
L9628	0764758	10.0	0.3937				38	38	•	
L9628	0764764	10.1	0.3976	39	42	42	•			
L9628	0764770	10.2	0.4016				39	39	•	
L9628	0764787	10.3	0.4055	40	43	43	•			
L9628	0764793	10.4	0.4094				40	40	•	
L9628	0764809	10.5	0.4134	41	44	44	•			
L9628	0764815	10.6	0.4173				41	41	•	
L9628	0764821	10.7	0.4213	42	45	45	•			
L9628	0764838	10.8	0.4252				42	42	•	
L9628	0764844	10.9	0.4291	43	46	46	•			
L9628	0764850	11.0	0.4331				43	43	•	
L9628	0764867	11.1	0.4370	44	47	47	•			
L9628	0764873	11.2	0.4409				44	44	•	
L9628	0764880	11.3	0.4449	45	48	48	•			
L9628	0764896	11.4	0.4488				45	45	•	
L9628	0764901	11.5	0.4528	46	49	49	•			
L9628	0764918	11.6	0.4567				46	46	•	
L9628	0764924	11.7	0.4606	47	50	50	•			
L9628	0764930	11.8	0.4646				47	47	•	
L9628	0764947	11.9	0.4685	48	51	51	•			
L9628	0764953	12.0	0.4724				48	48	•	
L9628	0764960	12.1	0.4764	49	52	52	•			
L9628	0764976	12.2	0.4803				49	49	•	
L9628	0764982	12.3	0.4843	50	53	53	•			
L9628	0764999	12.4	0.4882				50	50	•	
L9628	0765003	12.5	0.4921	51	54	54	•			
L9628	0765010	12.6	0.4961				51	51	•	
L9628	0765026	12.7	0.5000	52	55	55	•			
L9628	0765032	12.8	0.5039				52	52	•	
L9628	0765049	12.9	0.5079	53	56	56	•			
L9628	0764305	13.0	0.5118				53	53	•	
L9628	0764311	13.1	0.5157	54	57	57	•			
L9628	0764328	13.2	0.5197				54	54	•	
L9628	0764334	13.3	0.5236	55	58	58	•			
L9628	0764340	13.4	0.5276				55	55	•	
L9628	0764357	13.5	0.5315	56	59	59	•			
L9628	0764363	13.6	0.5354				56	56	•	
L9628	0764370	13.7	0.5394	57	60	60	•			
L9628	0764386	13.8	0.5433				57	57	•	
L9628	0764392	13.9	0.5472	58	61	61	•			
L9628	0764408	14.0	0.5512				58	58	•	
L9628	0764414	14.1	0.5551	59	59	•				

* Package Qty: 1 per Tube Size

HIGH PERFORMANCE DRILLS

L9628 Metric Size

*Japan Stock Item

List #	EDP #	Size	Decimal Equivalent	Flute Length ℓ	Overall Length L	L1	Shank Dia. Ds	Stock
L9628	0764420	14.2	0.5591	50	105	53	12	•
L9628	0764437	14.3	0.5630					•
L9628	0764443	14.4	0.5669	51		54		•
L9628	0764450	14.5	0.5709					•
L9628	0764466	14.6	0.5748	52		54		•
L9628	0764472	14.7	0.5787		•			
L9628	0764489	14.8	0.5827	53	54	•		
L9628	0764495	14.9	0.5866			•		
L9628	0764500	15.0	0.5906	54	54	•		
L9628	0764517	15.1	0.5945			•		
L9628	0764523	15.2	0.5984	55	57	•		
L9628	0764530	15.3	0.6024			•		
L9628	0764546	15.4	0.6063	55	57	•		
L9628	0764552	15.5	0.6102			•		

* Package Qty: 1 per Tube Size

List #	EDP #	Dc	ℓ	L	L1	Ds	Stock
L9628	0764569	15.6	0.6142	55	115	57	•
L9628	0764575	15.7	0.6181				•
L9628	0764581	15.8	0.6220	56	115	59	•
L9628	0764598	15.9	0.6260				•
L9628	0764603	16.0	0.6299	57	115	61	•
L9628	0764610	16.1	0.6338				•
L9628	0764626	17.0	0.6693	59	125	62	•
L9628	0764632	17.5	0.6890				•
L9628	0764649	18.0	0.7087	63	135	66	•
L9628	0764655	18.5	0.7283				•
L9628	0764661	19.0	0.7480	66	145	68	•
L9628	0764678	19.5	0.7677				•
L9628	0764684	20.0	0.7874	70	145	73	•
L9628	0764690	20.5	0.8071				•

⚠ WARNING: Cancer - www.P65Warnings.ca.gov

CARBIDE DRILLS

Drilling Conditions - Wet

LIST 9628

Work Material	Structural Steel Carbon Steel Cast Iron	Alloy Steel Heat Treated Steel (20 - 30 HRC)	Mold Steel Hardened Steel (30 - 40 HRC)	Ductile Cast Iron	Stainless Steel (300 Series)	Nickel Alloys PH Stainless	Aluminum Alloy	Aluminum Casting								
Speed (SFM)	235 - 255 SFM	210 - 230 SFM	110 - 130 SFM	210 - 230 SFM	80 - 100 SFM	75 - 85 SFM	340 - 360 SFM	300-320 SFM								
Drill Diameter Metric	RPM	Feed (IPR)	RPM	Feed (IPR)	RPM	Feed (IPR)	RPM	Feed (IPR)	RPM	Feed (IPR)	RPM	Feed (IPR)	RPM	Feed (IPR)	RPM	Feed (IPR)
	2.0	11400	0.0012	10450	0.0011	5350	0.0010	10200	0.0010	3900	0.0011	3650	0.0011	16500	0.0017	14600
3.0	7950	0.0020	6900	0.0020	3700	0.0020	6900	0.0015	2600	0.0020	2450	0.0018	11000	0.0025	9700	0.0020
4.0	5950	0.0025	5150	0.0025	2800	0.0025	5150	0.0025	1950	0.0023	1850	0.0020	8400	0.0030	7300	0.0025
5.0	4800	0.0035	4150	0.0035	2200	0.0030	4150	0.0030	1550	0.0026	1450	0.0022	6700	0.0040	5900	0.0035
6.0	4000	0.0040	3450	0.0040	1800	0.0035	3450	0.0035	1300	0.0031	1200	0.0026	5600	0.0045	4900	0.0040
8.0	3000	0.0055	2600	0.0055	1400	0.0050	2600	0.0045	970	0.0038	920	0.0032	4200	0.0065	3700	0.0055
10.0	2400	0.0070	2050	0.0070	1100	0.0060	2050	0.0060	780	0.0047	730	0.0039	3400	0.0080	3000	0.0070
12.0	2000	0.0085	1700	0.0085	950	0.0070	1700	0.0070	650	0.0057	610	0.0048	2800	0.0095	2500	0.0080
16.0	1500	0.0110	1300	0.0110	700	0.0095	1300	0.0095	550	0.0063	460	0.0057	2100	0.0125	1850	0.0110
20.0	1200	0.0140	1050	0.0135	550	0.0120	1050	0.0115	480	0.0066	370	0.0063	1700	0.0155	1500	0.0135

Cutting Condition Table Recommendations

- 1) Adjust cutting condition according to the rigidity of machine or work clamp state.
- 2) The table values are for drilling with water-soluble cutting fluid.
- 3) Reduce RPM and feed rate by 20% for non-water soluble coolant.

Drilling Conditions for Angled Surfaces				
Reduction % to above table values				
Degree of Angle	Reduction %		Reduction % (Multiplier)	
	RPM	Feed	RPM	Feed
0° - 5°	100%	100%	Table Value	Table Value
6° - 20°	50%	50%	(Table Value)x0.5	(Table Value)x0.5
21 - 35°	70%	40%	(Table Value)x0.3	(Table Value)x0.6
36° - 60°	70%	40%	(Table Value)x0.3	(Table Value)x0.6
61° and above	70%	30%	(Table Value)x0.3	(Table Value)x0.7

HIGH PERFORMANCE DRILLS

Aqua Drill EX Starting Drill

For use with Aqua Flat Drills (List 9819, 9817, 9815)

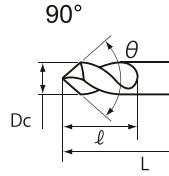

List 9624

Item Code	Size	Decimal Equivalent	Drill Point Angle	Flute Length	Overall Length	Shank Dia
EDP	Dc		90°	l	L	Ds
0727355	3.0	0.1181		9	48	3.0
0727361	4.0	0.1575		12	52	4.0
0727378	5.0	0.1969		14	60	5.0
0727384	6.0	0.2362		15	66	6.0
0727390	8.0	0.3150		20	79	8.0
0727406	10.0	0.3937		25	89	10.0
0727412	12.0	0.4724		30	102	12.0
0727429	16.0	0.6299		35	115	16.0
0727435	20.0	0.7874		40	131	20.0

Package Qty: 1 per Tube Size

WARNING: Cancer - www.P65Warnings.ca.gov

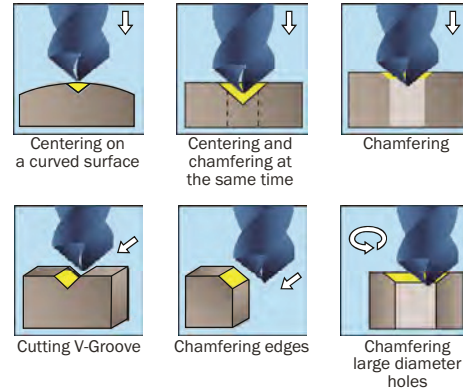

Standard Drilling Conditions

Centering

Work Material		Carbon Steels / Cast Irons <20 HRC		Alloy Steels 20 ~ 30 HRC		Mold Steels 30 ~ 40 HRC		Hardened Steel 40 ~ 50 HRC		Stainless Steel 300 /Series		Aluminum Alloy Copper Alloy	
Drill Diameter		RPM	Feed (IPM)	RPM	Feed (IPM)	RPM	Feed (IPM)	RPM	Feed (IPM)	RPM	Feed (IPM)	RPM	Feed (IPM)
Metric mm	Decimal												
3	0.118	7400	17.7	4800	11.4	2100	3.7	1900	2.8	2650	5.1	10600	43.3
4	0.157	5600	16.9	3600	10.2	1600	3.3	1450	2.6	2000	4.3	7950	41.3
5	0.197	4450	15.0	2850	9.4	1250	3.0	1150	2.4	1600	3.9	6350	37.4
6	0.236	3700	15.0	2400	9.4	1050	3.0	950	2.4	1300	3.9	5300	37.4
8	0.315	2800	15.0	1800	9.4	800	3.0	700	2.4	1000	3.9	4000	37.4
10	0.394	2200	13.0	1450	8.7	650	2.8	550	2.2	800	3.7	3200	31.5
12	0.472	1850	13.0	1200	8.7	530	2.8	480	2.2	650	3.7	2650	31.5
16	0.630	1400	11.4	900	7.5	400	2.6	350	2.0	500	3.5	2000	27.6
20	0.787	1100	10.2	720	6.7	320	2.6	280	2.0	400	3.1	1600	25.6

- Note : 1) Adjust drilling conditions according to the rigidity of machine or work clamp state.
 2) Above table values are for drilling water soluble cutting fluid. For non-water soluble cutting fluid reduce the RPM and feed rates by 20%
 3) Apply sufficient cutting fluid to work area.
 4) Use these cutting conditions for centering work.
 5) Reduce RPM and feed rates by 20% for centering work on rolled steel or forged surfaces, curved or angled surfaces.
 4) Use collet chucks or milling chucks.

Chamfering

Work Material		Carbon Steels / Cast Irons <20 HRC		Alloy Steels 20 ~ 30 HRC		Mold Steels/ Hardened Steels 30 ~ 40 HRC		Hardened Steel 40 ~ 50 HRC		Stainless Steel 300 /Series		Aluminum Alloy Copper Alloy	
Drill Diameter		RPM	Feed (IPM)	RPM	Feed (IPM)	RPM	Feed (IPM)	RPM	Feed (IPM)	RPM	Feed (IPM)	RPM	Feed (IPM)
Metric mm	Decimal												
3	0.118	7400	14.2	4800	9.1	2100	2.6	1900	2.0	2650	3.9	10600	35.0
4	0.157	5600	13.4	3600	8.3	1600	2.4	1450	1.8	2000	3.3	7950	33.1
5	0.197	4450	11.8	2850	7.5	1250	2.2	1150	1.6	1600	3.1	6350	29.9
6	0.236	3700	11.8	2400	7.5	1050	2.2	950	1.6	1300	3.1	5300	29.9
8	0.315	2800	11.8	1800	7.5	800	2.2	700	1.6	1000	3.1	4000	29.9
10	0.394	2200	10.2	1450	6.9	650	2.0	550	1.4	800	3.0	3200	25.2
12	0.472	1850	10.2	1200	6.9	530	2.0	480	1.4	650	3.0	2650	25.2
16	0.630	1400	9.1	900	5.9	400	1.8	350	1.2	500	2.8	2000	22.0
20	0.787	1100	8.3	720	5.3	320	1.8	280	1.2	400	2.4	1600	20.1

- Note : 1) Adjust drilling conditions according to the rigidity of machine or work clamp state.
 2) Above table values are for drilling water soluble cutting fluid. For non-water soluble cutting fluid reduce the RPM and feed rates by 20%
 3) Apply sufficient cutting fluid to work area.
 4) Use these cutting conditions for chamfering.
 5) Reduce RPM and feed rates at the same ratio if chattering occurs, because the workpiece is not rigidly mounted to the machine.
 4) Use collet chucks or milling chucks.

HIGH PERFORMANCE HSS/COBALT DRILLS

AG Starting Drill

For use with Aqua Flat Drills (List 9814, 9815, 9816, 9817, 9818, 9819)



List 6502 Metric Sizes

90° Range 3.0 to 20.0

140° Range 3.0 to 20.0

Item Code	Size	Decimal Equivalent	Drill Point Angle	Flute Length	Overall Length	Shank Dia
EDP	Dc			ℓ	L	Ds
0710358	3.0	0.1181	90°	9	48	3.0
0710364	4.0	0.1575		12	52	4.0
0712613	5.0	0.1969		14	60	5.0
0710370	6.0	0.2362		15	66	6.0
0710387	8.0	0.3150		20	79	8.0
0710393	10.0	0.3937		25	89	10.0
0710409	12.0	0.4724		30	102	12.0
0710415	16.0	0.6299		35	115	16.0
0710421	20.0	0.7874	40	131	20.0	
0710518	3.0	0.1181	140°	9	48	3.0
0710524	4.0	0.1575		12	52	4.0
0712636	5.0	0.1969		14	60	5.0
0710530	6.0	0.2362		15	66	6.0
0710547	8.0	0.3150		20	79	8.0
0710553	10.0	0.3937		25	89	10.0
0710560	12.0	0.4724		30	102	12.0
0710576	16.0	0.6299		35	115	16.0
0710582	20.0	0.7874	40	131	20.0	

Package Qty: 1 per Tube Size

⚠ WARNING: Cancer - www.P65Warnings.ca.gov

AG Starting Drill Extended Length

For use with Aqua Flat Drills (List 9814, 9815, 9816, 9817, 9818, 9819)



List 6504 Metric Sizes

90° Range 3.0 to 12.0

140° Range 3.0 to 12.0

Item Code	Size	Decimal Equivalent	Drill Point Angle	Flute Length	Overall Length	Shank Dia
EDP	Dc			ℓ	L	Ds
0710656	3.0	0.1181	90°	9	75	3.0
0710662	4.0	0.1575		12	100	4.0
0712659	5.0	0.1969		14	100	5.0
0710679	6.0	0.2362		15	150	6.0
0710685	8.0	0.3150		20	150	8.0
0710691	10.0	0.3937		25	200	10.0
0710707	12.0	0.4724		30	200	12.0
0710771	3.0	0.1181		140°	9	75
0710788	4.0	0.1575	12		100	4.0
0712671	5.0	0.1969	14		100	5.0
0710794	6.0	0.2362	15		150	6.0
0710800	8.0	0.3150	20		150	8.0
0710816	10.0	0.3937	25		200	10.0
0710822	12.0	0.4724	30		200	12.0

Package Qty: 1 per Tube Size

⚠ WARNING: Cancer - www.P65Warnings.ca.gov

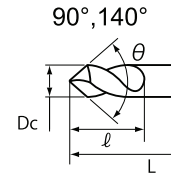

AREAS OF APPLICATION FOR AG STARTING

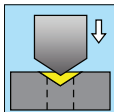
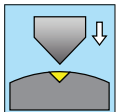

For Pre-Drilling of Drills that have inconsistent bite and drilling holes on curved or inclined surfaces

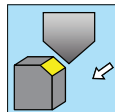
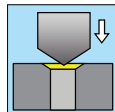

For Chamfering of Holes and Chamfering Edges

HIGH PERFORMANCE HSS/COBALT DRILLS

SG-ESS Drill Micro

High Performance (3xD)

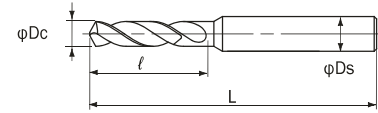

SG-ESS Drill Stub Length



LIST 7572P

Metric: Micro & Stub Length

LIST 7573P

Fractional, Wire & Letter

Metric Range .50 to 20.0
*Replacing AG-SUS Drill Short L6596P

EDP No.	Size	Decimal	Wire/Fractional Equivalent	Flute Length	Overall Length	Shank Dia.
EDP	Dc			ℓ	L	Ds
0716602	0.50	0.0197		3	38	3
0716705	0.51	0.0201	#76			
0716711	0.52	0.0205				
0716728	0.53	0.0209				
0716734	0.54	0.0213				
0716619	0.55	0.0217				
0716740	0.56	0.0220				
0716757	0.57	0.0224				
0716763	0.58	0.0228				
0716770	0.59	0.0232				
0716625	0.60	0.0236		3.5	38	3
0716786	0.61	0.0240	#73			
0716792	0.62	0.0244				
0716808	0.63	0.0248				
0716814	0.64	0.0252				
0716631	0.65	0.0256				
0716820	0.66	0.0260	#71			
0716837	0.67	0.0264				
0716843	0.68	0.0268				
0716850	0.69	0.0272				
0716648	0.70	0.0276		4.5	38	3
0716866	0.71	0.0280	#70			
0716872	0.72	0.0283				
0716889	0.73	0.0287				
0716895	0.74	0.0291				
0716654	0.75	0.0295				
0716900	0.76	0.0299				
0716917	0.77	0.0303				
0716923	0.78	0.0307	#68			
0716930	0.79	0.0311				
0716660	0.80	0.0315		5	38	3
0716946	0.81	0.0319				
0716952	0.82	0.0323	#67			
0716969	0.83	0.0327				
0716975	0.84	0.0331	#66			
0716677	0.85	0.0335				
0716981	0.86	0.0339				
0716998	0.87	0.0343				
0717002	0.88	0.0346				
0717019	0.89	0.0350	#65			
0716683	0.90	0.0354		5.5	38	3
0717025	0.91	0.0358				
0717031	0.92	0.0362				
0717048	0.93	0.0366				
0717054	0.94	0.0370	#63			
0716690	0.95	0.0374				
0717060	0.96	0.0378				
0717077	0.97	0.0382				
0717083	0.98	0.0386				
0717090	0.99	0.0390	#61			

EDP No.	Size	Decimal	Wire/Fractional Equivalent	Flute Length	Overall Length	Shank Dia.
EDP	Dc			ℓ	L	Ds
0573780	1.00	0.0394		6	38	3
0693862	1.01	0.0398				
0693879	1.02	0.0402	#60			
0693885	1.03	0.0406				
0693891	1.04	0.0409	#59			
0575347	1.05	0.0413				
0693907	1.06	0.0417				
0693913	1.07	0.0421	#58			
0693920	1.08	0.0425				
0693936	1.09	0.0429	#57			
0573797	1.10	0.0433		7	39	3
0693942	1.11	0.0437				
0693959	1.12	0.0441				
0693965	1.13	0.0445				
0693971	1.14	0.0449				
0575353	1.15	0.0453				
0693988	1.16	0.0457				
0693994	1.17	0.0461				
0694009	1.18	0.0465	#56			
0694015	1.19	0.0469	3/64			
0573802	1.20	0.0472		8	40	3
0694021	1.21	0.0476				
0694038	1.22	0.0480				
0694044	1.23	0.0484				
0694050	1.24	0.0488				
0575360	1.25	0.0492				
0694067	1.26	0.0496				
0694073	1.27	0.0500				
0694080	1.28	0.0504				
0694096	1.29	0.0508				
0573819	1.30	0.0512		9	41	3
0694101	1.31	0.0516				
0694118	1.32	0.0520	#55			
0694124	1.33	0.0524				
0694130	1.34	0.0528				
0575376	1.35	0.0531				
0694147	1.36	0.0535				
0694153	1.37	0.0539				
0694160	1.38	0.0543				
0694176	1.39	0.0547				
0573825	1.40	0.0551		9	41	3
0694182	1.41	0.0555				
0694199	1.42	0.0559				
0694204	1.43	0.0563				
0694210	1.44	0.0567				
0575382	1.45	0.0571				
0694227	1.46	0.0575				
0694233	1.47	0.0579				
0694240	1.48	0.0583				
0694256	1.49	0.0587				

HSS DRILLS

SG-ESS Drill Stub Length

L7572P Metric

L7573P Fractional, Wire & Letter

*Replacing AG-SUS Drill Short L6596P

HSS DRILLS

EDP No.	Size	Decimal	Wire/Fractional Equivalent	Flute Length	Overall Length	Shank Dia.
EDP	Dc			ℓ	L	Ds
0573831	1.50	0.0591		9	41	
0694262	1.51	0.0594	#53			
0694279	1.52	0.0598				
0694285	1.53	0.0602				
0694291	1.54	0.0606				
0575399	1.55	0.0610				
0694307	1.56	0.0614				
0694313	1.57	0.0618				
0694320	1.58	0.0622				
0694336	1.59	0.0626	1/16			
0573848	1.60	0.0630				
0694342	1.61	0.0634	#52	10	42	
0694359	1.62	0.0638				
0694365	1.63	0.0642				
0694371	1.64	0.0646				
0575404	1.65	0.0650				
0694388	1.66	0.0654				
0694394	1.67	0.0657				
0694400	1.68	0.0661				
0694416	1.69	0.0665				
0573854	1.70	0.0669				
0694422	1.71	0.0673				
0694439	1.72	0.0677				
0694445	1.73	0.0681				
0694451	1.74	0.0685				
0575410	1.75	0.0689				
0694468	1.76	0.0693				
0694474	1.77	0.0697				
0694480	1.78	0.0701	#50			
0694497	1.79	0.0705				
0573860	1.80	0.0709				
0694502	1.81	0.0713		11	43	3
0694519	1.82	0.0717				
0694525	1.83	0.0720	#49			
0694531	1.84	0.0724				
0575427	1.85	0.0728				
0694548	1.86	0.0732				
0694554	1.87	0.0736				
0694560	1.88	0.0740				
0694577	1.89	0.0744				
0573877	1.90	0.0748				
0694583	1.91	0.0752				
0694590	1.92	0.0756				
0694605	1.93	0.0760	#48			
0694611	1.94	0.0764				
0575433	1.95	0.0768				
0694628	1.96	0.0772				
0694634	1.97	0.0776				
0694640	1.98	0.0780	5/64			
0694657	1.99	0.0783	#47			
0572514	2.00	0.0787				
0694663	2.01	0.0791		12	44	
0694670	2.02	0.0795				
0694686	2.03	0.0799				
0694692	2.04	0.0803				
0575440	2.05	0.0807				
0694708	2.06	0.0811	#46			
0694714	2.07	0.0815				
0694720	2.08	0.0819				
1363043	2.08	0.0820	#45	3/4	2	1/8
0694737	2.09	0.0823		12	44	3

• USA Stock Size

EDP No.	Size	Decimal	Wire/Fractional Equivalent	Flute Length	Overall Length	Shank Dia.
EDP	Dc			ℓ	L	Ds
0572520	2.10	0.0827				
0694743	2.11	0.0831		12	44	
0694750	2.12	0.0835				
0694766	2.13	0.0839				
0694772	2.14	0.0843				
0575456	2.15	0.0846				
0694789	2.16	0.0850		13	45	3
0694795	2.17	0.0854				
0694800	2.18	0.0858				
1363050	2.18	0.0860	#44	3/4	2	1/8
0694817	2.19	0.0862				
0572537	2.20	0.0866				
0694823	2.21	0.0870				
0694830	2.22	0.0874		13	45	3
0694846	2.23	0.0878				
0694852	2.24	0.0882				
0575462	2.25	0.0886				
0694869	2.26	0.0890				
1363066	2.26	0.0890	#43	3/4	2	1/8
0694875	2.27	0.0894				
0694881	2.28	0.0898				
0694898	2.29	0.0902				
0572543	2.30	0.0906				
0694903	2.31	0.0909				
0694910	2.32	0.0913		13	45	3
0694926	2.33	0.0917				
0694932	2.34	0.0921				
0575479	2.35	0.0925				
0694949	2.36	0.0929				
0694955	2.37	0.0933		14	46	
1363072	2.37	0.0935	#42	3/4	2	1/8
0694961	2.38	0.0937		14	46	3
1245365	2.38	0.0938	3/32	1/2	1-3/4	1/8
0694978	2.39	0.0941				
0572550	2.40	0.0945				
0694984	2.41	0.0949		14	46	3
0694990	2.42	0.0953				
0695005	2.43	0.0957				
1363089	2.44	0.0960	#41	13/16	2-1/16	1/8
0695011	2.44	0.0961				
0575485	2.45	0.0965				
0695028	2.46	0.0969		14	46	3
0695034	2.47	0.0972				
0695040	2.48	0.0976				
0695057	2.49	0.0980				
1280931	2.49	0.0980	#40	13/16	2-1/16	1/8
0572566	2.50	0.0984				
0695063	2.51	0.0988		14	46	3
0695070	2.52	0.0992				
1363095	2.53	0.0995	#39	13/16	2-1/4	1/8
0695086	2.53	0.0996				
0695092	2.54	0.1000				
0575491	2.55	0.1004		14	46	3
0695108	2.56	0.1008				
0695114	2.57	0.1012				
1363100	2.58	0.1015	#38	13/16	2-1/4	1/8
0695120	2.58	0.1016				
0695137	2.59	0.1020				
0572572	2.60	0.1024		14	46	3
0695143	2.61	0.1028				
0695150	2.62	0.1031				

0.01mm size Diameter Tolerance : 0~-0.009mm

SG-ESS Drill Stub Length

L7572P Metric
L7573P Fractional, Wire & Letter

*Replacing AG-SUS Drill Short L6596P

EDP No.	Size	Decimal	Wire/Fractional Equivalent	Flute Length	Overall Length	Shank Dia.
EDP	Dc			ℓ	L	Ds
0695166	2.63	0.1035		14	46	3
0695172	2.64	0.1039		14	46	3
1363117	2.64	0.1040	#37	13/16	2-1/4	1/8
0575507	2.65	0.1043		14	46	
0695189	2.66	0.1047				
0695195	2.67	0.1051		16	48	3
0695200	2.68	0.1055				
0695217	2.69	0.1059				
0572589	2.70	0.1063				
1245823	2.71	0.1065	#36	13/16	2-1/4	1/8
0695223	2.71	0.1067				
0695230	2.72	0.1071				
0695246	2.73	0.1075				
0695252	2.74	0.1079		16	48	3
0575513	2.75	0.1083				
0695269	2.76	0.1087				
0695275	2.77	0.1091				
0695281	2.78	0.1094				
1245371	2.78	0.1094	7/64	5/8	1-7/8	1/8
0695298	2.79	0.1098				
0572595	2.80	0.1102		16	48	3
0695303	2.81	0.1106				
0695310	2.82	0.1110				
1363130	2.82	0.1110	#34	7/8	2-5/16	1/8
0695326	2.83	0.1114				
0695332	2.84	0.1118				
0575520	2.85	0.1122		16	48	3
0695349	2.86	0.1126				
0695355	2.87	0.1130				
1363146	2.87	0.1130	#33	7/8	2-5/16	1/8
0695361	2.88	0.1134				
0695378	2.89	0.1138				
0572600	2.90	0.1142				
0695384	2.91	0.1146				
0695390	2.92	0.1150				
0695406	2.93	0.1154				
0695412	2.94	0.1157		16	48	3
0575536	2.95	0.1161				
0695429	2.96	0.1165				
0695435	2.97	0.1169				
0695441	2.98	0.1173				
0695458	2.99	0.1177				
0572617	3.00	0.1181				
0695464	3.01	0.1185				
0695470	3.02	0.1189				
0695487	3.03	0.1193				
0695493	3.04	0.1197				
0575542	3.05	0.1201				
0695509	3.06	0.1205				
0695515	3.07	0.1209				
0695521	3.08	0.1213				
0695538	3.09	0.1217				
0572623	3.10	0.1220		18	50	4
0695544	3.11	0.1224				
0695550	3.12	0.1228				
0695567	3.13	0.1232				
0695573	3.14	0.1236				
0575559	3.15	0.1240				
0695580	3.16	0.1244				
0695596	3.17	0.1248				
1245388	3.18	0.1250	1/8	3/4	2	1/8
0695601	3.18	0.1252				
0695618	3.19	0.1256				
0572630	3.20	0.1260				
0695624	3.21	0.1264				
0695630	3.22	0.1268		18	50	4
0695647	3.23	0.1272				
0695653	3.24	0.1276				
0575565	3.25	0.1280				
0695660	3.26	0.1283				
1289836	3.26	0.1285	#30	15/16	2-3/8	3/16
0695676	3.27	0.1287				
0695682	3.28	0.1291				
0695699	3.29	0.1295		18	50	4
0572646	3.30	0.1299				

• USA Stock Size

EDP No.	Size	Decimal	Wire/Fractional Equivalent	Flute Length	Overall Length	Shank Dia.
EDP	Dc			ℓ	L	Ds
0695704	3.31	0.1303				
0695710	3.32	0.1307				
0695727	3.33	0.1311		18	50	
0695733	3.34	0.1315				
0575571	3.35	0.1319				
0695740	3.36	0.1323				
0695756	3.37	0.1327				
0695762	3.38	0.1331				
0695779	3.39	0.1335				
0572652	3.40	0.1339				
0695785	3.41	0.1343		20	52	4
0695791	3.42	0.1346				
0695807	3.43	0.1350				
0695813	3.44	0.1354				
0575588	3.45	0.1358				
0695820	3.46	0.1362				
1245817	3.46	0.1365	#29	15/16	2-3/8	3/16
0695836	3.47	0.1366				
0695842	3.48	0.1370				
0695859	3.49	0.1374				
0572669	3.50	0.1378				
0695865	3.51	0.1382		20	52	4
0695871	3.52	0.1386				
0695888	3.53	0.1390				
0695894	3.54	0.1394				
0575594	3.55	0.1398				
0695900	3.56	0.1402				
1363169	3.57	0.1405	#28	15/16	2-3/8	3/16
0695916	3.57	0.1406		20	52	4
1245394	3.57	0.1406	9/64	13/16	2-1/8	3/16
0695922	3.58	0.1409				
0695939	3.59	0.1413				
0572675	3.60	0.1417				
0695945	3.61	0.1421		20	52	4
0695951	3.62	0.1425				
0695968	3.63	0.1429				
0695974	3.64	0.1433				
0575600	3.65	0.1437				
1363175	3.66	0.1440	#27	1	2-7/16	3/16
0695980	3.66	0.1441				
0695997	3.67	0.1445				
0696001	3.68	0.1449				
0696018	3.69	0.1453		20	52	4
0572681	3.70	0.1457				
0696024	3.71	0.1461				
0696030	3.72	0.1465				
0696047	3.73	0.1469				
1363181	3.73	0.1470	#26	1	2-7/16	3/16
0696053	3.74	0.1472		20	52	
0575616	3.75	0.1476				
0696060	3.76	0.1480				
0696076	3.77	0.1484				
0696082	3.78	0.1488		22	54	4
0696099	3.79	0.1492				
1245800	3.80	0.1495	#25	1	2-7/16	3/16
0572698	3.80	0.1496				
0696104	3.81	0.1500				
0696110	3.82	0.1504				
0696127	3.83	0.1508		22	54	4
0696133	3.84	0.1512				
0575622	3.85	0.1516				
0696140	3.86	0.1520				
1363198	3.86	0.1520	#24	1	2-7/16	3/16
0696156	3.87	0.1524				
0696162	3.88	0.1528				
0696179	3.89	0.1531		22	54	4
0572703	3.90	0.1535				
0696185	3.91	0.1539				
1363203	3.91	0.1540	#23	1	2-7/16	3/16
0696191	3.92	0.1543				
0696207	3.93	0.1547				
0696213	3.94	0.1551		22	54	4
0575639	3.95	0.1555				
0696220	3.96	0.1559				

0.01mm size Diameter Tolerance : 0 ~-.009mm

HSS DRILLS

SG-ESS Drill Stub Length

L7572P Metric
L7573P Fractional, Wire & Letter

*Replacing AG-SUS Drill Short L6596P

HSS DRILLS

EDP No.	Size	Decimal	Wire/Fractional Equivalent	Flute Length	Overall Length	Shank Dia.
EDP	Dc			ℓ	L	Ds
0696236	3.97	0.1563		22	54	4
1245400	3.97	0.1563	5/32	13/16	2-1/8	3/16
0696242	3.98	0.1567		22	54	4
1363210	3.99	0.1570	#22	1-1/16	2-7/16	3/16
0696259	3.99	0.1571			54	4
0572710	4.00	0.1575				
0696265	4.01	0.1579		22		
0696271	4.02	0.1583			66	6
0696288	4.03	0.1587				
1245795	4.04	0.1590	#21	1-1/16	2-7/16	3/16
0696294	4.04	0.1591				
0575645	4.05	0.1594				
0696300	4.06	0.1598		22	66	6
0696316	4.07	0.1602				
0696322	4.08	0.1606				
0696339	4.09	0.1610				
1363226	4.09	0.1610	#20	1-1/16	2-7/16	3/16
0572726	4.10	0.1614				
0696345	4.11	0.1618				
0696351	4.12	0.1622				
0696368	4.13	0.1626				
0696374	4.14	0.1630				
0575651	4.15	0.1634		22	66	6
0696380	4.16	0.1638				
0696397	4.17	0.1642				
0696402	4.18	0.1646				
0696419	4.19	0.1650				
0572732	4.20	0.1654				
0696425	4.21	0.1657				
1363232	4.22	0.1660	#19	1-1/16	2-7/16	3/16
0696431	4.22	0.1661				
0696448	4.23	0.1665				
0696454	4.24	0.1669		22		
0575668	4.25	0.1673				
0696460	4.26	0.1677				
0696477	4.27	0.1681				
0696483	4.28	0.1685				
0696490	4.29	0.1689			68	6
0572749	4.30	0.1693				
0696505	4.31	0.1697		24		
0696511	4.32	0.1701				
0696528	4.33	0.1705				
0696534	4.34	0.1709				
0575674	4.35	0.1713				
0696540	4.36	0.1717				
1245416	4.37	0.1719	11/64	1	2-3/8	3/16
0696557	4.37	0.1720				
0696563	4.38	0.1724				
0696570	4.39	0.1728				
0572755	4.40	0.1732				
0696586	4.41	0.1736				
0696592	4.42	0.1740				
0696608	4.43	0.1744				
0696614	4.44	0.1748				
0575680	4.45	0.1752				
0696620	4.46	0.1756				
0696637	4.47	0.1760		24	68	6
0696643	4.48	0.1764				
0696650	4.49	0.1768				
0572761	4.50	0.1772				
0696666	4.51	0.1776				
0696672	4.52	0.1780				
0696689	4.53	0.1783				
0696695	4.54	0.1787				
0575697	4.55	0.1791				
0696700	4.56	0.1795				
0696717	4.57	0.1799				
1363278	4.57	0.1800	#15	1-1/8	2-9/16	3/16
0696723	4.58	0.1803				
0696730	4.59	0.1807				
0572778	4.60	0.1811		24	68	6
0696746	4.61	0.1815				
0696752	4.62	0.1819				
1363284	4.62	0.1820	#14	1-1/8	2-9/16	3/16

• USA Stock Size

EDP No.	Size	Decimal	Wire/Fractional Equivalent	Flute Length	Overall Length	Shank Dia.
EDP	Dc			ℓ	L	Ds
0696769	4.63	0.1823				
0696775	4.64	0.1827				
0575702	4.65	0.1831				
0696781	4.66	0.1835				
0696798	4.67	0.1839				
0696803	4.68	0.1843				
0696810	4.69	0.1846		24	68	6
0572784	4.70	0.1850				
0696826	4.71	0.1854				
0696832	4.72	0.1858				
0696849	4.73	0.1862				
0696855	4.74	0.1866				
0575719	4.75	0.1870				
0696861	4.76	0.1874				
1245422	4.76	0.1875	3/16	26	70	6
0696878	4.77	0.1878		1	2-3/8	3/16
0696884	4.78	0.1882				
0696890	4.79	0.1886				
0572790	4.80	0.1890				
0696906	4.81	0.1894				
0696912	4.82	0.1898				
0696929	4.83	0.1902				
0696935	4.84	0.1906		26	70	6
0575725	4.85	0.1909				
0696941	4.86	0.1913				
0696958	4.87	0.1917				
0696964	4.88	0.1921				
0696970	4.89	0.1925				
0572806	4.90	0.1929				
0696987	4.91	0.1933				
1363329	4.91	0.1935	#10	1-3/16	3	1/4
0696993	4.92	0.1937				
0697008	4.93	0.1941				
0697014	4.94	0.1945		26	70	6
0575731	4.95	0.1949				
0697020	4.96	0.1953				
0697037	4.97	0.1957				
1363335	4.98	0.1960	#9	1-3/16	3	1/4
0697043	4.98	0.1961				
0697050	4.99	0.1965				
0572812	5.00	0.1969				
0697066	5.01	0.1972		26	70	6
0697072	5.02	0.1976				
0697089	5.03	0.1980				
0697095	5.04	0.1984				
0575748	5.05	0.1988				
1280954	5.05	0.1990	#8	1-3/16	3	1/4
0697100	5.06	0.1992				
0697117	5.07	0.1996				
0697123	5.08	0.2000		26	70	6
0697130	5.09	0.2004				
0572829	5.10	0.2008				
1245789	5.11	0.2010	#7	1-3/16	3	1/4
0697146	5.11	0.2012				
0697152	5.12	0.2016				
0697169	5.13	0.2020		26	70	6
0697175	5.14	0.2024				
0575754	5.15	0.2028				
0697181	5.16	0.2031				
1245439	5.16	0.2031	13/64	1-1/8	2-7/8	1/4
0697198	5.17	0.2035		26	70	6
0697203	5.18	0.2039				
1280960	5.18	0.2040	#6	1-1/4	3-1/16	1/4
0697210	5.19	0.2043				
0572835	5.20	0.2047		26	70	6
0697226	5.21	0.2051				
0697232	5.22	0.2055				
1363341	5.22	0.2055	#5	1-1/4	3-1/16	1/4
0697249	5.23	0.2059				
0697255	5.24	0.2063				
0575760	5.25	0.2067		26	70	6
0697261	5.26	0.2071				
0697278	5.27	0.2075				
0697284	5.28	0.2079				

0.01mm size Diameter Tolerance : 0 ~ -.009mm

SG-ESS Drill Stub Length

L7572P Metric

L7573P Fractional, Wire & Letter

*Replacing AG-SUS Drill Short L6596P

EDP No.	Size	Decimal	Wire, Fractional & Letter Equivalent	Flute Length	Overall Length	Shank Dia.
EDP	Dc			ℓ	L	Ds
0697290	5.29	0.2083		26	70	6
0572841	5.30	0.2087				
1363358	5.31	0.2090	#4	1-1/4	3-1/16	1/4
0697306	5.31	0.2091				
0697312	5.32	0.2094				
0697329	5.33	0.2098				
0697335	5.34	0.2102				
0575777	5.35	0.2106				
0697341	5.36	0.2110		28	72	6
0697358	5.37	0.2114				
0697364	5.38	0.2118				
0697370	5.39	0.2122				
0572858	5.40	0.2126				
0697387	5.41	0.2130				
1363364	5.41	0.2130	#3	1-1/4	3-1/16	1/4
0697393	5.42	0.2134				
0697409	5.43	0.2138				
0697415	5.44	0.2142				
0575783	5.45	0.2146				
0697421	5.46	0.2150				
0697438	5.47	0.2154				
0697444	5.48	0.2157		28	72	6
0697450	5.49	0.2161				
0572864	5.50	0.2165				
0697467	5.51	0.2169				
0697473	5.52	0.2173				
0697480	5.53	0.2177				
0697496	5.54	0.2181				
0575790	5.55	0.2185				
1245445	5.56	0.2188	7/32	1-1/8	2-7/8	1/4
0697501	5.56	0.2189				
0697518	5.57	0.2193				
0697524	5.58	0.2197				
0697530	5.59	0.2201		28	72	6
0572870	5.60	0.2205				
0697547	5.61	0.2209				
1363370	5.61	0.2210	#2	1-5/16	3-1/8	1/4
0697553	5.62	0.2213				
0697560	5.63	0.2217				
0697576	5.64	0.2220				
0575805	5.65	0.2224				
0697582	5.66	0.2228				
0697599	5.67	0.2232				
0697604	5.68	0.2236				
0697610	5.69	0.2240				
0572887	5.70	0.2244				
0697627	5.71	0.2248		28	72	6
0697633	5.72	0.2252				
0697640	5.73	0.2256				
0697656	5.74	0.2260				
0575811	5.75	0.2264				
0697662	5.76	0.2268				
0697679	5.77	0.2272				
0697685	5.78	0.2276				
0697691	5.79	0.2280				
1363387	5.79	0.2280	#1	1-5/16	3-1/8	1/4
0572893	5.80	0.2283				
0697707	5.81	0.2287				
0697713	5.82	0.2291				
0697720	5.83	0.2295				
0697736	5.84	0.2299				
0575828	5.85	0.2303				
0697742	5.86	0.2307				
0697759	5.87	0.2311				
0697765	5.88	0.2315		28	72	6
0697771	5.89	0.2319				
0572909	5.90	0.2323				
0697788	5.91	0.2327				
0697794	5.92	0.2331				
0697800	5.93	0.2335				
0697816	5.94	0.2339				
0575834	5.95	0.2343				
1245451	5.95	0.2344	15/64	1-1/4	3	1/4
0697822	5.96	0.2346				
0697839	5.97	0.2350				
0697845	5.98	0.2354		28	72	6
0697851	5.99	0.2358				
0572915	6.00	0.2362				
1363409	6.05	0.2380	B	1-3/8	3-3/16	1/4

• USA Stock Size

EDP No.	Size	Decimal	Wire/Letter Equivalent	Flute Length	Overall Length	Shank Dia.
EDP	Dc			ℓ	L	Ds
0572921	6.10	0.2402		31	75	8
1363415	6.15	0.2420	C	1-3/8	3-3/16	1/4
0572938	6.20	0.2441		31	75	8
1363421	6.25	0.2460	D	1-3/8	3-3/16	1/4
0572944	6.30	0.2480		31	75	8
1245468	6.35	0.2500	1/4	1-1/4	3	1/4
0572950	6.40	0.2520		31	75	8
0572967	6.50	0.2559		31	75	8
1245830	6.53	0.2570	F	1-7/16	3-1/4	3/8
0572973	6.60	0.2598		31	75	8
1363444	6.63	0.2610	G	1-7/16	3-1/4	3/8
0572980	6.70	0.2638		31	75	8
1245474	6.75	0.2656	17/64	1-3/8	3-3/16	3/8
0572996	6.80	0.2677		34	78	8
0573000	6.90	0.2717		34	78	8
1363450	6.91	0.2720	I	1-1/2	3-5/16	3/8
0573017	7.00	0.2756		34	78	8
1363467	7.04	0.2770	J	1-1/2	3-5/16	3/8
0573023	7.10	0.2795		34	78	8
1245480	7.14	0.2813	9/32	1-3/8	3-3/16	3/8
0573030	7.20	0.2835		34	78	8
0573046	7.30	0.2874		34	78	8
1363473	7.37	0.2900	L	1-9/16	3-3/8	3/8
0573052	7.40	0.2913		34	78	8
1363480	7.49	0.2950	M	1-9/16	3-3/8	3/8
0573069	7.50	0.2953		34	78	8
1245497	7.54	0.2969	19/64	1-3/8	3-3/16	3/8
0573075	7.60	0.2992		37	81	8
1363496	7.67	0.3020	N	1-5/8	3-7/16	3/8
0573081	7.70	0.3031				
0573098	7.80	0.3071		37	81	8
0573103	7.90	0.3110				
1245502	7.94	0.3125	5/16	1-1/2	3-3/8	3/8
0573110	8.00	0.3150		37	81	8
1363501	8.03	0.3160	O	1-11/16	3-1/2	3/8
0573126	8.10	0.3189				
0573132	8.20	0.3228		37	87	10
0573149	8.30	0.3268				
1245519	8.33	0.3281	21/64	1-1/2	3-3/8	3/8
0573155	8.40	0.3307		37	87	10
1363524	8.43	0.3320	Q	1-11/16	3-1/2	3/8
0573161	8.50	0.3346		37	87	10
0573178	8.60	0.3386		40	90	10
1363530	8.61	0.3390	R	1-11/16	3-1/2	3/8
0573184	8.70	0.3425		40	90	10
1245525	8.73	0.3438	11/32	1-5/8	3-1/2	3/8
0573190	8.80	0.3465				
0573206	8.90	0.3504		40	90	10
0573212	9.00	0.3543				
0573229	9.10	0.3583				
1245531	9.13	0.3594	23/64	1-5/8	3-1/2	3/8
0573235	9.20	0.3622		40	90	10
0573241	9.30	0.3661		40	90	10
1280977	9.35	0.3680	U	1-13/16	3-5/8	3/8
0573258	9.40	0.3701		40	90	10
0573264	9.50	0.3740		40	90	10
1245548	9.53	0.3750	3/8	1-5/8	3-1/2	3/8
1363560	9.58	0.3770	V	1-7/8	3-31/32	1/2
0573270	9.60	0.3780				
0573287	9.70	0.3819				
0573293	9.80	0.3858		43	93	10
0573309	9.90	0.3898				
1245554	9.92	0.3906	25/64	1-11/16	3-7/8	1/2
0573315	10.00	0.3937		43	93	10
1363582	10.08	0.3970	X	1-15/16	4-1/32	1/2
0573321	10.10	0.3976		43	93	10
0573338	10.20	0.4016		43	100	12
1363599	10.26	0.4040	Y	1-15/16	4-1/32	1/2
0573344	10.30	0.4055		43	100	12
1245560	10.32	0.4063	13/32	1-11/16	3-7/8	1/2
0573350	10.40	0.4094		43	100	12
1363604	10.49	0.4130	Z	2	4-3/32	1/2
0573367	10.50	0.4134		43	100	12
0573373	10.60	0.4173		43	100	12
0573380	10.70	0.4213		47	104	12
1245577	10.72	0.4219	27/64	1-7/8	4-1/8	1/2
0573396	10.80	0.4252				
0573401	10.90	0.4291		47	104	12
0573418	11.00	0.4331				

0.01mm size Diameter Tolerance : 0 ~ -.009mm

HSS DRILLS

HIGH PERFORMANCE HSS/COBALT DRILLS

SG-ESS Drill Stub Length

L7572P

Metric

L7573P

Fractional, Wire & Letter

*Replacing AG-SUS Drill Short L6596P

HSS DRILLS

EDP No.	Size	Decimal	Wire/Fractional Equivalent	Flute Length	Overall Length	Shank Dia.
EDP	Dc			ℓ	L	Ds
0573424	11.10	0.4370		47	104	12
1245583	11.11	0.4375	7/16	1-7/8	4-1/8	1/2
0573430	11.20	0.4409				
0573447	11.30	0.4449		47	104	12
0573453	11.40	0.4488				
0573460	11.50	0.4528				
1245590	11.51	0.4531	29/64	1-7/8	4-1/8	1/2
0573476	11.60	0.4567				
0573482	11.70	0.4606		47	104	12
0573499	11.80	0.4646				
0573504	11.90	0.4685		51	108	12
1245605	11.91	0.4688	15/32	2	4-1/4	1/2
0573510	12.00	0.4724				
0573527	12.10	0.4764				
0573533	12.20	0.4803		51	108	12
0573540	12.30	0.4843				
1245611	12.30	0.4844	31/64	2	4-1/4	1/2
0573556	12.40	0.4882				
0573562	12.50	0.4921				
0573579	12.60	0.4961		51	108	12
0573585	12.70	0.5000				
1245628	12.70	0.5000	1/2	2	4-1/4	1/2
0573591	12.80	0.5039				
0573607	12.90	0.5079		51	108	12

EDP No.	Size	Decimal	Wire/Fractional Equivalent	Flute Length	Overall Length	Shank Dia.
EDP	Dc			ℓ	L	Ds
0573613	13.00	0.5118		51	108	12
1280851	13.49	0.5313	17/32	2-7/8	5-3/16	5/8
0573620	13.50	0.5315		72	132	16
0573636	14.00	0.5512		72	132	16
1280868	14.29	0.5625	9/16	3	5-3/8	1/2
0573642	14.50	0.5709		76	136	16
0573659	15.00	0.5906		76	142	20
1280874	15.08	0.5938	19/32	3	5-5/8	3/4
0573665	15.50	0.6102		80	146	20
1280880	15.88	0.6250	5/8	3-3/16	5-3/4	3/4
0573671	16.00	0.6299		80	146	20
0573688	16.50	0.6496		84	150	20
1280897	16.67	0.6563	21/32	3-3/8	5-15/16	3/4
0573694	17.00	0.6693		84	150	20
1280902	17.46	0.6875	11/16	3-7/16	6	3/4
0573700	17.50	0.6890		87	153	20
0573716	18.00	0.7087		87	153	20
1280919	18.26	0.7188	23/32	3-7/16	6	7/8
0573722	18.50	0.7283		90	156	20
0573739	19.00	0.7480		90	164	25
1280925	19.05	0.7500	3/4	3-9/16	6-1/2	7/8
0573745	19.50	0.7677		94	168	25
0573751	20.00	0.7874		94	168	25

1 per tube

⚠ WARNING: Cancer - www.P65Warnings.ca.gov

Standard Drilling Conditions

L7572, 7573

Work Material			Structural Steel Carbon Steel		Alloy Steel (20-30 HRC)		Die Steels Hardened Steels		Stainless Steel 300 Series		Nickel Alloys Titanium Alloys PH Stainless		Cast Iron		Aluminum Alloys Copper Alloy	
Speed (SFM)			80 - 90 SFM		65 - 85 SFM		35 - 45 SFM		20 - 30 SFM		10 -20 SFM		100 - 110 SFM		110 - 120 SFM	
Drill Diameter			RPM	Feed (IPR)	RPM	Feed (IPR)	RPM	Feed (IPR)	RPM	Feed (IPR)	RPM	Feed (IPR)	RPM	Feed (IPR)	RPM	Feed (IPR)
Fractional	Metric	Dec. Inch														
	0.5		16000	0.0005	13000	0.0004	7750	0.0004	5250	0.0004	2500	0.0003	20000	0.0005	23000	0.0006
	0.75		10500	0.0008	8550	0.0007	5100	0.0006	3800	0.0006	2150	0.0005	13100	0.0008	15150	0.0009
Speed (SFM)			115 - 135 SFM		95 - 105 SFM		40 - 50 SFM		30 - 50 SFM		20 -30 SFM		115 - 135 SFM		120 - 140 SFM	
	1	0.0394	11200	0.0010	9200	0.0009	3900	0.0008	3600	0.0008	1950	0.0006	11200	0.0010	13100	0.0012
	2	0.0787	5600	0.0020	4600	0.0018	1950	0.0016	1450	0.0016	970	0.0012	5600	0.0020	6550	0.0024
3/32	2.381	0.0937	4700	0.0028	3900	0.0026	1450	0.0024	1200	0.0024	820	0.0018	4100	0.0035	4500	0.0036
	3	0.1181	3700	0.0037	3100	0.0035	1150	0.0031	940	0.0031	650	0.0022	3250	0.0045	3550	0.0048
1/8	3.175	0.1250	3500	0.0040	2900	0.0037	1100	0.0032	890	0.0032	610	0.0024	3050	0.0055	3350	0.0055
5/32	3.969	0.1563	2800	0.0050	2350	0.0047	850	0.0038	710	0.0038	490	0.0030	2450	0.0066	2700	0.0066
3/16	4.763	0.1875	2350	0.0060	1950	0.0056	720	0.0045	590	0.0045	410	0.0032	2050	0.0079	2250	0.0078
	5	0.1969	2250	0.0067	1850	0.0059	680	0.0047	560	0.0047	390	0.0033	1950	0.0083	2150	0.0081
1/4	6.35	0.2500	1750	0.0080	1450	0.0072	540	0.0057	440	0.0057	310	0.0042	1500	0.0101	1700	0.0101
5/16	7.938	0.3125	1400	0.0094	1150	0.0088	430	0.0072	350	0.0072	240	0.0053	1200	0.0121	1350	0.0114
	8	0.3150	1400	0.0094	1150	0.0088	430	0.0072	350	0.0072	240	0.0054	1200	0.0122	1350	0.0116
3/8	9.525	0.3750	1200	0.0103	970	0.0092	360	0.0082	300	0.0082	200	0.0064	1000	0.0132	1150	0.0125
	10	0.3937	1100	0.0108	920	0.0094	340	0.0087	280	0.0087	190	0.0067	1000	0.0135	1100	0.0131
	12	0.4724	930	0.0113	770	0.0109	280	0.0094	240	0.0094	160	0.0080	810	0.0144	890	0.0149
1/2	12.7	0.5000	880	0.0120	730	0.0110	270	0.0095	220	0.0095	150	0.0082	770	0.0151	840	0.0154
	16.0	0.6299	700	0.0145	580	0.0132	220	0.0107	170	0.0107	120	0.0094	610	0.0172	670	0.0174
	20.0	0.7874	560	0.0165	460	0.0142	170	0.0118	140	0.0118	100	0.0102	490	0.0202	530	0.0205
	25.0	0.9843	450	0.0187	370	0.0157	140	0.0128	110	0.0128	80	0.0123	390	0.0231	430	0.0229
	32.0	1.2598	350	0.0189	290	0.0157	110	0.0132	90	0.0132	60	0.0132	300	0.0222	330	0.0230

Cutting Condition Table Recommendations

- 1) Adjust drilling condition according to the rigidity of the machine or workholding.
- 2) The table values are for drilling with water-soluble cutting fluid in vertical and horizontal machines.
- 3) When drilling stainless or other tough to machine materials, use peck drilling.
- 4) When pecking, set retract to the hole entrance.
- 5) Peck increment should be 0.5xD - 1xD. For small diameters, use 0.2xD - 0.5xD.
- 6) Recommended feeds and speeds are starting points only and may require adjustment based on specific material, condition of equipment, and coolant condition.

Formulas: $RPM = \frac{SFM \times 3.82}{\text{Drill Diam.}}$ $\text{Feed Rate (in/min)} = RPM \times IPR$

HIGH PERFORMANCE HSS/COBALT DRILLS

SG-ESR Drill



L7574P Metric

L7575P Fractional, Wire & Letter

Metric Range 2.0 to 32.0
Fractional Range 3/32 to 3/4

EDP No.	Size	Decimal Equivalent	Wire / Fractional Equivalent	Flute Length	Overall Length	Shank Dia.
EDP	Dc			ℓ	L	Ds
0721821	2.00	0.0787		24	56	3
1464190	2.08	0.0820	#45	1-1/8	2-3/8	1/8
0721838	2.10	0.0827		24	56	3
1464206	2.18	0.0860	#44	1-1/8	2-3/8	1/8
0721844	2.20	0.0866		25	56	3
1464212	2.26	0.0890	#43	1-1/4	2-1/2	1/8
0721850	2.30	0.0906		25	56	3
1464229	2.37	0.0935	#42	1-1/4	2-1/2	1/8
1464739	2.38	0.0938	3/32	1-1/8	2-3/8	1/8
0721867	2.40	0.0945		30	61	3
1464235	2.44	0.0960	#41			
1464241	2.49	0.0980	#40	1-3/8	2-5/8	1/8
0721873	2.50	0.0984		30	61	3
1464258	2.53	0.0995	#39	1-3/8	2-13/16	1/8
1464264	2.58	0.1015	#38	1-7/16	2-7/8	1/8
0721880	2.60	0.1024		30	61	3
1464270	2.64	0.1040	#37	1-7/16	2-7/8	1/8
0721896	2.70	0.1063		33	64	3
1464287	2.71	0.1065	#36	1-7/16	2-7/8	1/8
1464745	2.78	0.1094	7/64	1-1/4	2-1/2	1/8
0721901	2.80	0.1102		33	64	3
1464293	2.82	0.1110	#34			
1464309	2.87	0.1130	#33	1-1/2	2-15/16	1/8
0721918	2.90	0.1142		33	64	3
0721924	3.00	0.1181				
0721930	3.10	0.1220		36	68	4
1464751	3.18	0.1250	1/8	1-3/8	2-5/8	1/8
0721947	3.20	0.1260		36	68	4
1464315	3.26	0.1285	#30	1-5/8	3-1/16	3/16
0721953	3.30	0.1299		36	68	4
0721960	3.40	0.1339		39	71	4
1464321	3.47	0.1365	#29	1-3/4	3-3/16	3/16
0721976	3.50	0.1378		39	71	4
1464338	3.57	0.1405	#28	1-3/4	3-3/16	3/16
1464768	3.57	0.1406	9/64	1-1/2	2-7/8	3/16
0721982	3.60	0.1417		39	71	4
1464344	3.66	0.1440	#27	1-7/8	3-5/16	3/16
0721999	3.70	0.1457		39	71	4
1464350	3.73	0.1470	#26	1-7/8	3-5/16	3/16
1464367	3.80	0.1495	#25			
0722003	3.80	0.1496		43	75	4
1464373	3.86	0.1520	#24	2	3-7/16	3/16
0722010	3.90	0.1535		43	75	4
1464380	3.91	0.1540	#23	2	3-7/16	3/16
1464774	3.97	0.1563	5/32	1-3/4	3-1/8	3/16
1464396	3.99	0.1570	#22	2	3-7/16	3/16
0722026	4.00	0.1575		43	75	4
1464401	4.04	0.1590	#21			
1464418	4.09	0.1610	#20	2-1/8	3-9/16	3/16
0722032	4.10	0.1614		43	85	6
0722049	4.20	0.1654				
1464424	4.22	0.1660	#19	2-1/8	3-9/16	3/16
0722055	4.30	0.1693		47	89	6
1464780	4.37	0.1719	11/64	1-7/8	3-1/4	3/16
0722061	4.40	0.1732		47	89	6
0722078	4.50	0.1772				
1464430	4.57	0.1800	#15	2-3/16	3-5/8	3/16

• USA Stock Size

EDP No.	Size	Decimal Equivalent	Wire / Fractional Equivalent	Flute Length	Overall Length	Shank Dia.
EDP	Dc			ℓ	L	Ds
0722084	4.60	0.1811		47	89	6
1464447	4.62	0.1820	#14	2-3/16	3-5/8	3/16
0722090	4.70	0.1850		47	89	6
1464797	4.76	0.1875	3/16	2	3-3/8	3/16
0722106	4.80	0.1890		52	94	6
0722112	4.90	0.1929				
1464453	4.91	0.1935	#10	2-7/16	4-1/4	1/4
1464460	4.98	0.1960	#9			
0722129	5.00	0.1969		52	94	6
1464476	5.05	0.1990	#8	2-7/16	4-1/4	1/4
0722135	5.10	0.2008		52	94	6
1464482	5.11	0.2010	#7	2-7/16	4-1/4	1/4
1464802	5.16	0.2031	13/64	2-1/16	3-7/8	1/4
1464499	5.18	0.2040	#6	2-7/16	4-1/4	1/4
0722141	5.20	0.2047		52	94	6
1464504	5.22	0.2055	#5	2-1/2	4-5/16	1/4
0722158	5.30	0.2087		52	94	6
1464510	5.31	0.2090	#4	2-1/2	4-5/16	1/4
0722164	5.40	0.2126		57	99	6
1464527	5.41	0.2130	#3	2-1/2	4-5/16	1/4
0722170	5.50	0.2165		57	99	6
1464819	5.56	0.2188	7/32	2-1/16	3-7/8	1/4
0722187	5.60	0.2205		57	99	6
1464533	5.61	0.2210	#2	2-5/8	4-7/16	1/4
0722193	5.70	0.2244		57	99	6
1464540	5.79	0.2280	#1	2-5/8	4-7/16	1/4
0722209	5.80	0.2283		57	99	6
0722215	5.90	0.2323				
1464825	5.95	0.2344	15/64	2-3/8	4-1/4	1/4
0722221	6.00	0.2362		57	99	6
1464556	6.05	0.2380	B	2-3/4	4-9/16	1/4
0722238	6.10	0.2402		63	107	8
1464562	6.15	0.2420	C	2-3/4	4-9/16	1/4
0722244	6.20	0.2441		63	107	8
1464579	6.25	0.2460	D	2-3/4	4-9/16	1/4
0722250	6.30	0.2480		63	107	8
1464831	6.35	0.2500	1/4	2-3/8	4-1/4	1/4
0722267	6.40	0.2520				
0722273	6.50	0.2559		63	107	8
1464585	6.53	0.2570	F	2-7/8	4-11/16	3/8
0722280	6.60	0.2598		63	107	8
1464591	6.63	0.2610	G	2-7/8	4-11/16	3/8
0722296	6.70	0.2638		63	107	8
1464848	6.75	0.2656	17/64	2-3/4	4-5/8	3/8
0722301	6.80	0.2677		69	113	8
0722318	6.90	0.2717				
1464607	6.91	0.2720	I	2-7/8	4-11/16	3/8
0722324	7.00	0.2756		69	113	8
1464613	7.04	0.2770	J	2-7/8	4-11/16	3/8
0722330	7.10	0.2795		69	113	8
1464854	7.15	0.2813	9/32	2-3/4	4-5/8	3/8
0722347	7.20	0.2835				
0722353	7.30	0.2874		69	113	8
1464620	7.37	0.2900	L	2-15/16	4-3/4	3/8
0722360	7.40	0.2913		69	113	8
1464636	7.49	0.2950	M	3-1/16	4-7/8	3/8
0722376	7.50	0.2953		69	113	8

1 per tube

HSS DRILLS

HIGH PERFORMANCE HSS/COBALT DRILLS

L7574P
L7575P

Metric
Fractional

Metric Range 2.0 to 32.0
Fractional Range 3/32 to 3/4

HSS DRILLS

EDP No.	Size	Decimal Equivalent	Wire / Fractional Equivalent	Flute Length	Overall Length	Shank Dia.
EDP	Dc			ℓ	L	Ds
1464860	7.54	0.2969	19/64	2-7/8	4-3/4	3/8
0722382	7.60	0.2992		75	119	8
1464642	7.67	0.3020	N	3-1/16	4-7/8	3/8
0722399	7.70	0.3031				
0722404	7.80	0.3071		75	119	8
0722410	7.90	0.3110				
1464877	7.94	0.3125	5/16	2-7/8	4-3/4	3/8
0722427	8.00	0.3150		75	119	8
1464659	8.03	0.3160	0	3-3/16	5	3/8
0722433	8.10	0.3189				
0722440	8.20	0.3228		75	125	10
0722456	8.30	0.3268				
1464883	8.33	0.3281	21/64	2-7/8	4-3/4	3/8
0722462	8.40	0.3307		75	125	10
1464665	8.43	0.3320	Q	3-7/16	5-1/4	3/8
0722479	8.50	0.3346		75	125	10
0722485	8.60	0.3386		81	131	10
1464671	8.61	0.3390	R	3-7/16	5-1/4	3/8
0722491	8.70	0.3425		81	131	10
1464890	8.73	0.3438	11/32	3-1/4	5-1/8	3/8
0722507	8.80	0.3465				
0722513	8.90	0.3504		81	131	10
0722520	9.00	0.3543				
0722536	9.10	0.3583				
1464905	9.13	0.3594	23/64	3-1/4	5-1/8	3/8
0722542	9.20	0.3622		81	131	10
0722559	9.30	0.3661				
1464688	9.35	0.3680	U	3-5/8	5-7/16	3/8
0722565	9.40	0.3701		81	131	10
0722571	9.50	0.3740				
1464911	9.53	0.3750	3/8	3-1/4	5-1/8	3/8
1464694	9.58	0.3770	V	3-5/8	5-23/32	1/2
0722588	9.60	0.3780				
0722594	9.70	0.3819		87	137	10
0722600	9.80	0.3858				
0722616	9.90	0.3898				
1464928	9.92	0.3906	25/64	3-3/8	5-1/2	1/2
0722622	10.00	0.3937		87	137	10
1464700	10.08	0.3970	X	3-3/4	5-27/32	1/2
0722639	10.10	0.3976		87	144	12
0722645	10.20	0.4016				
1464716	10.26	0.4040	Y	3-7/8	5-31/32	1/2
0722651	10.30	0.4055		87	144	12
1464934	10.32	0.4063	13/32	3-3/8	5-1/2	1/2
0722668	10.40	0.4094		87	144	12
1464722	10.49	0.4130	Z	3-7/8	5-31/32	1/2
0722674	10.50	0.4134				
0722680	10.60	0.4173		87	144	12
0722697	10.70	0.4213		94	151	12
1464940	10.72	0.4219	27/64	3-3/4	5-7/8	1/2
0722702	10.80	0.4252				
0722719	10.90	0.4291		94	151	12
0722725	11.00	0.4331				
0722731	11.10	0.4370				
1464957	11.11	0.4375	7/16	3-3/4	5-7/8	1/2
0722748	11.20	0.4409				
0722754	11.30	0.4449		94	151	12
0722760	11.40	0.4488				
0722777	11.50	0.4528				
1464963	11.51	0.4531	29/64	3-3/4	5-7/8	1/2
0722783	11.60	0.4567				
0722790	11.70	0.4606		94	151	12
0722805	11.80	0.4646				

• USA Stock Size

EDP No.	Size	Decimal Equivalent	Wire / Fractional Equivalent	Flute Length	Overall Length	Shank Dia.
EDP	Dc			ℓ	L	Ds
0722811	11.90	0.4685		101	158	12
1464970	11.91	0.4688	15/32	4	6-1/4	1/2
0722828	12.00	0.4724				
0722834	12.10	0.4764		101	158	12
0722840	12.20	0.4803				
0722857	12.30	0.4843				
1464986	12.30	0.4844	31/64	4	6-1/4	1/2
0722863	12.40	0.4882				
0722870	12.50	0.4921		101	158	12
0722886	12.60	0.4961				
0722892	12.70	0.5000				
1464992	12.70	0.5000	1/2	4	6-1/4	1/2
0722908	12.80	0.5039				
0722914	12.90	0.5079		101	158	12
0722920	13.00	0.5118				
1465007	13.50	0.5313	17/32	4-1/4	6-3/4	5/8
0722937	13.50	0.5315		108	168	16
0722943	14.00	0.5512				
1465013	14.29	0.5625	9/16	4-1/2	7	5/8
0722950	14.50	0.5709		114	173	16
1465020	14.68	0.5781	37/64	4-1/2	7	5/8
0722966	15.00	0.5906		114	180	20
1465036	15.08	0.5938	19/32	4-3/4	7-1/4	3/4
0722972	15.50	0.6102		120	185	20
1465042	15.88	0.6250	5/8	4-3/4	7-1/4	3/4
0722989	16.00	0.6299		120	185	20
0722995	16.50	0.6496		125	189	20
1465059	16.67	0.6563	21/32	5	7-1/2	3/4
0723000	17.00	0.6693		125	189	20
1465065	17.46	0.6875	11/16	5-1/8	7-5/8	3/4
0723016	17.50	0.6890		130	194	20
0723022	18.00	0.7087		135	206	20
1465071	18.26	0.7188	23/32	5-3/8	7-3/4	7/8
0723039	18.50	0.7283		140	210	20
0723045	19.00	0.7480		135	206	25
1465088	19.05	0.7500	3/4	5-1/2	7-7/8	7/8
0723051	19.50	0.7677				
0723068	20.00	0.7874		140	210	
0723074	20.50	0.8071			214	
0723080	21.00	0.8268		145		
0723097	21.50	0.8465		150	218	25
0723102	22.00	0.8661				
0723119	22.50	0.8858				
0723125	23.00	0.9055		155	223	
0723131	23.50	0.9252				
0723148	24.00	0.9449		160	237	
0723154	24.50	0.9646				
0723160	25.00	0.9843				
0723177	25.50	1.0039		165	241	
0723183	26.00	1.0236				
0723190	26.50	1.0433				
0723205	27.00	1.0630				
0723211	27.50	1.0827		170	245	32
0723228	28.00	1.1024				
0723234	28.50	1.1220				
0723240	29.00	1.1417		175	248	
0723257	29.50	1.1614				
0723263	30.00	1.1811				
0723270	30.50	1.2008				
0723286	31.00	1.2205		180	252	
0723292	31.50	1.2402				
0723308	32.00	1.2598		185		

1 per tube

⚠ WARNING: Cancer - www.P65Warnings.ca.gov

Standard Drilling Conditions

LIST 7574, 7575

Work Material			Structural Steel Carbon Steel		Alloy Steel (20-30 HRC)		Die Steels Hardened Steels		Stainless Steel 300 Series		Nickel Alloys Titanium Alloys PH Stainless		Cast Iron		Aluminum Alloys Copper Alloy	
Speed (SFM)			80 - 90 SFM		65 - 85 SFM		35 - 45 SFM		20 - 30 SFM		10 - 20 SFM		100 - 110 SFM		110 - 120 SFM	
Drill Diameter			RPM	Feed (IPR)	RPM	Feed (IPR)	RPM	Feed (IPR)	RPM	Feed (IPR)	RPM	Feed (IPR)	RPM	Feed (IPR)	RPM	Feed (IPR)
Fractional	Metric	Dec. Inch														
	2	0.0787	5600	0.0020	4600	0.0018	1950	0.0014	1450	0.0014	970	0.0011	5600	0.0020	6550	0.0024
3/32	2.381	0.0937	4700	0.0028	3900	0.0023	1450	0.0019	1200	0.0019	820	0.0014	4100	0.0035	4500	0.0033
	3	0.1181	3700	0.0037	3100	0.0031	1150	0.0022	940	0.0022	650	0.0019	3250	0.0045	3550	0.0044
1/8	3.175	0.1250	3500	0.0040	2900	0.0034	1100	0.0024	890	0.0024	610	0.0021	3050	0.0055	3350	0.0053
5/32	3.969	0.1563	2800	0.0050	2350	0.0042	850	0.0034	710	0.0034	490	0.0024	2450	0.0066	2700	0.0063
3/16	4.763	0.1875	2350	0.0054	1950	0.0049	720	0.0041	590	0.0041	410	0.0029	2050	0.0079	2250	0.0073
	5	0.1969	2250	0.0063	1850	0.0054	680	0.0044	560	0.0044	390	0.0030	1950	0.0083	2150	0.0074
1/4	6.35	0.2500	1750	0.0074	1450	0.0061	540	0.0053	440	0.0053	310	0.0039	1500	0.0101	1700	0.0084
5/16	7.938	0.3125	1400	0.0078	1150	0.0065	430	0.0072	350	0.0072	240	0.0044	1200	0.0121	1350	0.0104
	8	0.3150	1400	0.0079	1150	0.0066	430	0.0072	350	0.0072	240	0.0044	1200	0.0122	1350	0.0104
3/8	9.525	0.3750	1200	0.0082	970	0.0072	360	0.0078	300	0.0078	200	0.0052	1000	0.0132	1150	0.0112
	10	0.3937	1100	0.0084	920	0.0073	340	0.0084	280	0.0084	190	0.0054	1000	0.0135	1100	0.0114
	12	0.4724	930	0.0094	770	0.0084	280	0.0099	240	0.0099	160	0.0063	810	0.0144	890	0.0122
1/2	12.7	0.5000	880	0.0105	730	0.0090	270	0.0102	220	0.0102	150	0.0068	770	0.0151	840	0.0124
	16.0	0.6299	700	0.0124	580	0.0104	220	0.0107	170	0.0107	120	0.0081	610	0.0172	670	0.0154
	20.0	0.7874	560	0.0144	460	0.0123	170	0.0118	140	0.0118	100	0.0092	490	0.0202	530	0.0174
	25.0	0.9843	450	0.0149	370	0.0132	140	0.0128	110	0.0128	80	0.0105	390	0.0231	430	0.0194
	32.0	1.2598	350	0.0154	290	0.0144	110	0.0145	90	0.0145	60	0.0115	300	0.0222	330	0.0196

Cutting Condition Table Recommendations

- 1) Adjust drilling condition according to the rigidity of the machine or workholding.
- 2) The table values are for drilling with water-soluble cutting fluid in vertical and horizontal machines.
- 3) When drilling stainless or other tough to machine materials, use peck drilling.
- 4) When pecking, set retract to the hole entrance.
- 5) Peck increment should be 0.5xD - 1xD.
- 6) Recommended feeds and speeds are starting points only and may require adjustment based on specific material, condition of equipment, and coolant condition.

Formulas:
$$\text{RPM} = \frac{\text{SFM} \times 3.82}{\text{Drill Diam.}}$$

$$\text{Feed Rate (in/min)} = \text{RPM} \times \text{IPR}$$

HIGH PERFORMANCE HSS/COBALT DRILLS

SG Drill Oil Hole



L7596P Metric Range 5.0 to 20.0 mm

L7591P Fractional Range 15/64 to 3/4

HSS DRILLS

EDP No.	Size	Decimal Equivalent	Fractional Equivalent	Flute Length	Overall Length
EDP	Dc			ℓ	L
1314751	5.0	0.1969		52	94
1314768	5.5	0.2165		57	99
1315065		0.2344	15/64	2-3/8	4-1/4
1314774	6.0	0.2362		57	99
1315071		0.2500	1/4	2-3/8	4-1/4
1314780	6.5	0.2559		63	107
1315088		0.2656	17/64	2-3/4	4-5/8
1314797	7.0	0.2756		69	113
1315094		0.2813	9/32	2-3/4	4-5/8
1314802	7.5	0.2953		69	113
1315100		0.2969	19/64	2-7/8	4-3/4
1315116		0.3125	5/16	2-7/8	4-3/4
1314819	8.0	0.3150		75	119
1315122		0.3281	21/64	2-7/8	4-3/4
1314825	8.5	0.3346		75	125
1315139		0.3438	11/32	3-1/4	5-1/8
1314831	9.0	0.3543		81	131
1315145		0.3594	23/64	3-1/4	5-1/8
1314848	9.5	0.3740		81	131
1315151		0.3750	3/8	3-1/4	5-1/8
1315168		0.3906	25/64	3-3/8	5-1/2
1314854	10.0	0.3937		87	137
1315174		0.4063	13/32	3-3/8	5-1/2
1314860	10.5	0.4134		87	144
1315180		0.4219	27/64	3-3/4	5-7/8
1314877	11.0	0.4331		94	151
1315197		0.4375	7/16	3-3/4	5-7/8
1314883	11.5	0.4528		94	151
1315202		0.4531	29/64	3-3/4	5-7/8

• USA Stock Size

EDP No.	Size	Decimal Equivalent	Fractional Equivalent	Flute Length	Overall Length
EDP	Dc			ℓ	L
1315219		0.4688	15/32	4	6-1/4
1314890	12.0	0.4724		101	158
1315225		0.4844	31/64	4	6-1/4
1314905	12.5	0.4921		101	158
1315231		0.5000	1/2	4	6-1/4
1314911	13.0	0.5118		101	158
1315248		0.5313	17/32	4-1/4	6-3/4
1314928	13.5	0.5315		108	168
1314934	14.0	0.5512		108	168
1315254		0.5625	9/16	4-1/2	7
1314940	14.5	0.5709		114	173
1315260		0.5781	37/64	4-1/2	7
1314957	15.0	0.5906		114	180
1315277		0.5938	19/32	4-3/4	7-1/4
1314963	15.5	0.6102		120	185
1315283		0.6250	5/8	4-3/4	7-1/4
1314970	16.0	0.6299		120	185
1314986	16.5	0.6496		125	189
1315290		0.6563	21/32	5	7-1/2
1314992	17.0	0.6693		125	189
1315305		0.6875	11/16	5-1/8	7-5/8
1315007	17.5	0.6890		130	194
1315013	18.0	0.7087		130	194
1315311		0.7188	23/32	5-3/8	7-3/4
1315020	18.5	0.7283		135	198
1315036	19.0	0.7480		135	206
1315328		0.7500	3/4	5-1/2	7-7/8
1315042	19.5	0.7677		140	210
1315059	20.0	0.7874			

⚠ WARNING: Cancer - www.P65Warnings.ca.gov

Standard Drilling Conditions

Workpiece Material			Structural Steels Carbon Steels		Alloy Steels		Die Steels Hardened Steels (35-45HRC)		Stainless Steels		Cast Irons		Aluminum Alloys Copper Alloys Nonferrous Alloys	
Speed (SFM)			120 - 130 SFM		105 - 110 SFM		40 - 50 SFM		60 - 70 SFM		130 - 150 SFM		200 - 230 SFM	
Drill Diameter			RPM		RPM		RPM		RPM		RPM		RPM	
Fractional	Metric mm	Decimal	Feed (IPR)	Feed (IPR)	Feed (IPR)	Feed (IPR)	Feed (IPR)	Feed (IPR)	Feed (IPR)	Feed (IPR)	Feed (IPR)	Feed (IPR)	Feed (IPR)	Feed (IPR)
—	5.000	0.1969	2,400	0.007	1,900	0.006	850	0.005	1,200	0.005	2,700	0.009	4,100	0.009
1/4	6.350	0.2500	1,900	0.008	1,500	0.008	650	0.006	1,000	0.006	2,100	0.011	3,300	0.011
5/16	7.938	0.3125	1,500	0.008	1,250	0.008	550	0.007	800	0.007	1,700	0.013	2,650	0.013
—	8.000	0.3150	1,500	0.009	1,200	0.009	550	0.009	750	0.008	1,700	0.014	2,600	0.014
3/8	9.525	0.3750	1,250	0.010	1,000	0.010	500	0.009	700	0.009	1,500	0.014	2,200	0.014
—	10.000	0.3937	1,200	0.011	950	0.011	450	0.010	650	0.010	1,400	0.016	2,000	0.016
—	12.000	0.4724	1,000	0.011	800	0.011	400	0.010	550	0.010	1,200	0.016	1,700	0.016
1/2	12.700	0.5000	950	0.013	750	0.013	350	0.012	500	0.013	1,100	0.019	1,600	0.019
—	16.000	0.6299	750	0.014	600	0.014	250	0.014	400	0.015	850	0.021	1,300	0.021
—	20.000	0.7874	600	0.015	450	0.015	200	0.014	300	0.015	650	0.022	1,000	0.021

- The above values apply when coolant is used in vertical machine & horizontal machine. When drilling in stainless steel and hard to cut material using pecking.
- Adjust drilling condition when unusual vibration or different sound occurs.
- Recommended feeds & speeds are starting points only. Actual performance will be determined by specific material, the condition of equipment being used and coolant.

Formulas: $RPM = \frac{SFM \times 3.82}{\text{Drill Diam.}}$ $\text{Feed Rate (in/min)} = RPM \times IPR$

HIGH PERFORMANCE HSS/COBALT DRILLS

AG Power Long Drill



L6540P Metric Sizes Series 1 Range 1.0 to 13.0 Series 2 Range 1.0 to 10.0 Series 3 Range 3.0 to 10.0
 L6541P Fractional Sizes Series 1 Range 1/8 to 3/8 Series 2 Range 1/8 to 3/8 Series 3 Range 1/8 to 5/16

Series 1

EDP	Fractional Size	Size	Decimal Equivalent	Flute Length	Overall Length	EDP	Fractional Size	Size	Decimal Equivalent	Flute Length	Overall Length	EDP	Fractional Size	Size	Decimal Equivalent	Flute Length	Overall Length
0640796		1.0000	0.0394	33	56	1372909	9/32	7.1440	0.2813			0641820		4.7000	0.1850	125	185
0640801		1.1000	0.0433	37	60	0641333		7.5000	0.2953	102	156	1373017	3/16	4.7620	0.1875		
0640818		1.2000	0.0472			1372915	19/64	7.5410	0.2969			0641837		4.8000	0.1890		
0640824		1.3000	0.0512	41	65	1372921	5/16	7.9330	0.3125			0641843		4.9000	0.1929		
0640830		1.4000	0.0551			0641340		8.0000	0.3150	109	165	0641850		5.0000	0.1969		
0640847		1.5000	0.0591	45	70	1372938	21/64	8.3340	0.3281			0641866		5.1000	0.2008	135	195
0640853		1.6000	0.0630			0641356		8.5000	0.3346			1373023	13/64	5.1590	0.2031		
0640860		1.7000	0.0669	50	76	1372944	11/32	8.7310	0.3437			0641872		5.2000	0.2047		
0640876		1.8000	0.0709			0641362		9.0000	0.3543			0641889		5.3000	0.2087		
0640882		1.9000	0.0748	53	80	1372950	23/64	9.1280	0.3594	115	175	0641895		5.4000	0.2126		
0640899		2.0000	0.0787			0641379		9.5000	0.3740			0641900		5.5000	0.2165		
0640904		2.1000	0.0827	56	85	1372967	3/8	9.5250	0.3750			1373030	7/32	5.5600	0.2187		
0640910		2.2000	0.0866			0641385		10.0000	0.3937	121	184	0641917		5.6000	0.2205	140	205
0640927		2.3000	0.0906	59	90	0641391		10.5000	0.4134			0641923		5.7000	0.2244		
0640933		2.4000	0.0945			0641407		11.0000	0.4331			0641930		5.8000	0.2283		
0640940		2.5000	0.0984	62	95	0641413		11.5000	0.4528	128	195	0641946		5.9000	0.2323		
0640956		2.6000	0.1024			0641420		12.0000	0.4724			0641952		6.0000	0.2362		
0640962		2.7000	0.1063			0641436		12.5000	0.4921	134	205	1373046	1/4	6.3500	0.2500	150	215
0640979		2.8000	0.1102			0641442		13.0000	0.5118			0641969		6.5000	0.2559		
0640985		2.9000	0.1142	66	100	Series 2						1373052	17/64	6.7470	0.2656		
0640991		3.0000	0.1181			EDP	Fractional Size	Size	Decimal Equivalent	Flute Length	Overall Length	0641975		6.8000	0.2677		
0641006		3.1000	0.1220			0641459		1.0000	0.0394	60	100	0641981		7.0000	0.2756	155	225
1372812	1/8	3.1750	0.1250			0641465		1.1000	0.0433			1373069	9/32	7.1440	0.2813		
0641012		3.2000	0.1260	69	106	0641471		1.2000	0.0472			0641998		7.5000	0.2953		
0641029		3.3000	0.1299			0641488		1.3000	0.0512	65	105	1373075	19/64	7.5410	0.2969		
0641035		3.4000	0.1339			0641494		1.4000	0.0551			1373081	5/16	7.9330	0.3125		
0641041		3.5000	0.1378			0641500		1.5000	0.0591	70	110	0642002		8.0000	0.3150	165	240
1372829	9/64	3.5720	0.1406	73	112	0641516		1.6000	0.0630			1373098	21/64	8.3340	0.3281		
0641058		3.6000	0.1417			0641522		1.7000	0.0669	75	115	0642019		8.5000	0.3346		
0641064		3.7000	0.1457			0641539		1.8000	0.0709			1373103	11/32	8.7310	0.3437		
0641070		3.8000	0.1496			0641545		1.9000	0.0748	80	120	0642025		9.0000	0.3543	175	250
0641087		3.9000	0.1535			0641551		2.0000	0.0787			1373110	23/64	9.1280	0.3594		
1372835	5/32	3.9690	0.1563	78	119	0641568		2.1000	0.0827	85	125	0642031		9.5000	0.3740		
0641093		4.0000	0.1575			0641574		2.2000	0.0866			1373126	3/8	9.5250	0.3750	185	265
0641109		4.1000	0.1614			0641580		2.3000	0.0906	90	135	0642048		10.0000	0.3937		
0641115		4.2000	0.1654			0641597		2.4000	0.0945			Series 3					
0641121		4.3000	0.1693			0641602		2.5000	0.0984	95	140	EDP	Fractional Size	Size	Decimal Equivalent	Flute Length	Overall Length
1372841	11/64	4.3660	0.1719			0641619		2.6000	0.1024			0642054		3.0000	0.1181	130	190
0641138		4.4000	0.1732			0641625		2.7000	0.1063			1373132	1/8	3.1750	0.1250	135	200
0641144		4.5000	0.1772			0641631		2.8000	0.1102			0642060		3.5000	0.1378		
0641150		4.6000	0.1811			0641648		2.9000	0.1142	100	150	1373149	9/64	3.5720	0.1406	145	210
0641167		4.7000	0.1850			0641654		3.0000	0.1181			1373155	5/32	3.9690	0.1563	150	220
1372858	3/16	4.7620	0.1875			0641660		3.1000	0.1220			0642077		4.0000	0.1575		
0641173		4.8000	0.1890			1372973	1/8	3.1750	0.1250			1373161	11/64	4.3660	0.1719		
0641180		4.9000	0.1929			0641677		3.2000	0.1260	105	155	0642083		4.5000	0.1772	160	235
0641196		5.0000	0.1969			0641683		3.3000	0.1299			1373178	3/16	4.7620	0.1875	170	245
0641201		5.1000	0.2008			0641690		3.4000	0.1339			0642090		5.0000	0.1969		
1372864	13/64	5.1590	0.2031			0641705		3.5000	0.1378			0642105		5.5000	0.2165		
0641218		5.2000	0.2047			1372980	9/64	3.5720	0.1406	115	165	1373184	7/32	5.5600	0.2187	180	260
0641224		5.3000	0.2087			0641711		3.6000	0.1417			0642111		6.0000	0.2362		
0641230		5.4000	0.2126			0641728		3.7000	0.1457			1373190	1/4	6.3500	0.2500	190	275
0641247		5.5000	0.2165			0641734		3.8000	0.1496			0642128		6.5000	0.2559		
1372870	7/32	5.5650	0.2187			0641740		3.9000	0.1535			0642134		7.0000	0.2756	200	290
0641253		5.6000	0.2205			1372996	5/32	3.9690	0.1563	120	175	0642140		7.5000	0.2953		
0641260		5.7000	0.2244			0641757		4.0000	0.1575			1373206	5/16	7.9330	0.3125		
0641276		5.8000	0.2283			0641763		4.1000	0.1614			0642157		8.0000	0.3150	210	305
0641282		5.9000	0.2323			0641770		4.2000	0.1654			0642163		8.5000	0.3346		
0641299		6.0000	0.2362			0641786		4.3000	0.1693			0642170		9.0000	0.3543	220	320
1372887	1/4	6.3500	0.2500			1373000	11/64	4.3660	0.1719			0642186		9.5000	0.3740		
0641304		6.5000	0.2559			0641792		4.4000	0.1732	125	185	0642192		10.0000	0.3937	235	340
1372893	17/64	6.7470	0.2656			0641808		4.5000	0.1772								
0641310		6.8000	0.2677	102	156	0641814		4.6000	0.1811								
0641327		7.0000	0.2756														

1 per tube

*Metric Size is Japan item: Please allow 2-3 weeks delivery

WARNING: Cancer - www.P65Warnings.ca.gov

HIGH PERFORMANCE HSS/COBALT DRILLS

Standard Drilling Conditions

List No. 6540P, 6541P

Workpiece Material			Structural Steels, Carbon Steels		Alloy Steels		Hardened Steels, (-40 HRc), Tool Steels		Stainless Steels 300-400 Series		Cast Irons	
Speed (SFM)			40 - 80 SFM		25 - 50 SFM		16 - 35 SFM		30 - 40 SFM		42 - 82 SFM	
Drill Diameter			RPM	Feed (IPR)	RPM	Feed (IPR)	RPM	Feed (IPR)	RPM	Feed (IPR)	RPM	Feed (IPR)
Fractional	Metric mm	Decimal										
—	1	0.0394	5,800	0.0007	3,300	0.0007	2,400	0.0005	2,900	0.0006	6,000	0.0008
—	2	0.0787	2,900	0.002	1,600	0.002	1,200	0.002	1,400	0.0015	3,000	0.002
—	3	0.1181	1,950	0.003	1,100	0.003	800	0.002	950	0.002	2,000	0.003
1/8	3.175	0.1250	1,800	0.003	1,000	0.003	750	0.002	900	0.002	1,800	0.003
3/16	4.763	0.1875	1,200	0.005	700	0.005	500	0.004	600	0.003	1,200	0.005
—	5	0.1969	1,100	0.005	650	0.005	480	0.004	550	0.004	1,200	0.006
—	6	0.2362	970	0.006	550	0.006	400	0.005	450	0.004	1,000	0.007
1/4	6.350	0.2500	900	0.006	500	0.006	350	0.005	450	0.004	950	0.008
9/32	7.144	0.2813	800	0.007	450	0.007	350	0.005	400	0.005	850	0.009
5/16	7.938	0.3125	700	0.008	400	0.008	300	0.006	350	0.006	800	0.010
—	8	0.3150	700	0.008	400	0.008	300	0.006	350	0.006	750	0.009
23/64	9	0.3594	650	0.009	350	0.009	250	0.007	300	0.007	700	0.010
—	10	0.3937	600	0.010	350	0.009	250	0.008	300	0.007	650	0.013
—	13	0.5118	550	0.009	300	0.009	200	0.008	250	0.008	600	0.011

- 1) Pilot Hole is required. It is recommended to use same diameter or up to 0.1mm larger than diameter of the long drill.
The depth of cut of the pilot hole is 1 to 2 times diameter of the drill diameter.
- 2) Above drilling table is applied to Series 1 & 2. In case of series 3 & 4, reduce the RPM and feed to 80% of table values.
- 3) Use pecking when drilling in Stainless Steel & Hardened Steels.
- 4) Recommended feeds and speeds are starting points only. Actual performance will be determined by specific material, the condition of equipment being used and coolant.

Formulas: $RPM = \frac{SFM \times 3.82}{\text{Drill dia.}}$ Feed Rate (in/min) = RPM x IPR

HIGH PERFORMANCE HSS/COBALT DRILLS

DLC Drill



L544 High Performance - DLC Coated

Range 1.0 to 13.0

(Unit) : mm

EDP	Size	Decimal Equivalent	Flute Length	Overall Length	Shank Dia
0642426	1.0000	0.0394	12	50	3
0642432	1.1000	0.0433	14		
0642449	1.2000	0.0472	16		
0642455	1.3000	0.0512	18		
0642461	1.4000	0.0551	18	56	
0642478	1.5000	0.0591	20		
0642484	1.6000	0.0630	22		
0642490	1.7000	0.0669	24		
0642506	1.8000	0.0709	22	64	
0642512	1.9000	0.0748	24		
0642529	2.0000	0.0787	25		
0642535	2.1000	0.0827	30		
0642541	2.2000	0.0866	30	64	
0642558	2.3000	0.0906	33		
0642564	2.4000	0.0945	33		
0642570	2.5000	0.0984	36		
0642587	2.6000	0.1024	36	71	
0642593	2.7000	0.1063	39		
0642609	2.8000	0.1102	39		
0642615	2.9000	0.1142	43		
0642621	3.0000	0.1181	43	75	
0642638	3.1000	0.1220	47		
0642644	3.2000	0.1260	47		
0642650	3.3000	0.1299	47		
0642667	3.4000	0.1339	47	89	
0642673	3.5000	0.1378	52		
0642680	3.6000	0.1417	52		
0642696	3.7000	0.1457	57		
0642701	3.8000	0.1496	57	94	
0642718	3.9000	0.1535	63		
0642724	4.0000	0.1575	63		
0642730	4.1000	0.1614	63		
0642747	4.2000	0.1654	63	99	
0642753	4.3000	0.1693	69		
0642760	4.4000	0.1732	69		
0642776	4.5000	0.1772	69		
0642782	4.6000	0.1811	69	107	
0642799	4.7000	0.1850	69		
0642804	4.8000	0.1890	69		
0642810	4.9000	0.1929	69		
0642827	5.0000	0.1969	69	113	
0642833	5.1000	0.2008	69		
0642840	5.2000	0.2047	69		
0642856	5.3000	0.2087	69		
0642862	5.4000	0.2126	69	113	
0642879	5.5000	0.2165	69		
0642885	5.6000	0.2205	69		
0642891	5.7000	0.2244	69		
0642907	5.8000	0.2283	69	113	
0642913	5.9000	0.2323	69		
0642920	6.0000	0.2362	69		
0642936	6.1000	0.2402	69		
0642942	6.2000	0.2441	69	113	
0642959	6.3000	0.2480	69		
0642965	6.4000	0.2520	69		
0642971	6.5000	0.2559	69		
0642988	6.6000	0.2598	69	113	
0642994	6.7000	0.2638	69		
0643009	6.8000	0.2677	69		
0643015	6.9000	0.2717	69		
0643021	7.0000	0.2756	69		

EDP	Size	Decimal Equivalent	Flute Length	Overall Length	Shank Dia
0643038	7.1000	0.2795	69	113	8
0643044	7.2000	0.2835			
0643050	7.3000	0.2874			
0643067	7.4000	0.2913			
0643073	7.5000	0.2953	75	119	
0643080	7.6000	0.2992			
0643096	7.7000	0.3031			
0643101	7.8000	0.3071			
0643118	7.9000	0.3110	81	125	
0643124	8.0000	0.3150			
0643130	8.1000	0.3189			
0643147	8.2000	0.3228			
0643153	8.3000	0.3268	87	131	
0643160	8.4000	0.3307			
0643176	8.5000	0.3346			
0643182	8.6000	0.3386			
0643199	8.7000	0.3425	87	137	
0643204	8.8000	0.3465			
0643210	8.9000	0.3504			
0643227	9.0000	0.3543			
0643233	9.1000	0.3583	94	144	
0643240	9.2000	0.3622			
0643256	9.3000	0.3661			
0643262	9.4000	0.3701			
0643279	9.5000	0.3740	94	151	
0643285	9.6000	0.3780			
0643291	9.7000	0.3819			
0643307	9.8000	0.3858			
0643313	9.9000	0.3898	101	158	
0643320	10.0000	0.3937			
0643336	10.1000	0.3976			
0643342	10.2000	0.4016			
0643359	10.3000	0.4055	101	158	
0643365	10.4000	0.4094			
0643371	10.5000	0.4134			
0643388	10.6000	0.4173			
0643394	10.7000	0.4213	101	158	
0643400	10.8000	0.4252			
0643416	10.9000	0.4291			
0643422	11.0000	0.4331			
0643439	11.1000	0.4370	101	158	
0643445	11.2000	0.4409			
0643451	11.3000	0.4449			
0643468	11.4000	0.4488			
0643474	11.5000	0.4528	101	158	
0643480	11.6000	0.4567			
0643497	11.7000	0.4606			
0643502	11.8000	0.4646			
0643519	11.9000	0.4685	101	158	
0643525	12.0000	0.4724			
0643531	12.1000	0.4764			
0643548	12.2000	0.4803			
0643554	12.3000	0.4843	101	158	
0643560	12.4000	0.4882			
0643577	12.5000	0.4921			
0643583	12.6000	0.4961			
0643590	12.7000	0.5000	101	158	
0643605	12.8000	0.5039			
0643611	12.9000	0.5079			
0643628	13.0000	0.5118			

1 per tube
*JAPAN STOCK ITEM : Please allow 2-3 weeks delivery

HSS DRILLS

HIGH PERFORMANCE HSS/COBALT DRILLS

Standard Drilling Condition

L544

Drilling in Wet Condition

Workpiece Material		Aluminum 1017		Aluminum Alloys						Aluminum Alloy Casting		Copper Alloys	
				4032, 6061		5052		7075					
Speed (SFM)		330 - 390 SFM		210 - 260 SFM		280 - 330 SFM		210 - 260 SFM		210 - 260 SFM		150 - 200 SFM	
Drill Diameter		330 - 390 SFM		210 - 260 SFM		280 - 330 SFM		210 - 260 SFM		210 - 260 SFM		150 - 200 SFM	
Metric mm	Decimal	RPM	Feed (IPR)	RPM	Feed (IPR)	RPM	Feed (IPR)	RPM	Feed (IPR)	RPM	Feed (IPR)	RPM	Feed (IPR)
1	0.0394	30,600	0.001	20,400	0.001	25,500	0.001	20,400	0.001	20,400	0.001	15,300	0.001
2	0.0787	19,100	0.002	12,700	0.002	15,900	0.002	12,700	0.002	12,700	0.002	9,600	0.002
3	0.1181	12,700	0.003	8,500	0.003	10,600	0.003	8,500	0.002	8,500	0.002	6,400	0.002
5	0.1969	7,600	0.005	5,100	0.005	6,400	0.005	5,100	0.004	5,100	0.004	3,800	0.004
8	0.3150	4,800	0.008	3,200	0.008	4,000	0.008	3,200	0.006	3,200	0.006	2,400	0.006
10	0.3937	3,800	0.010	2,500	0.010	3,200	0.010	2,500	0.008	2,500	0.008	1,900	0.008
12	0.4724	3,200	0.012	2,100	0.012	2,700	0.012	2,100	0.009	2,100	0.009	1,600	0.009
16	0.6299	2,400	0.013	1,600	0.013	2,000	0.013	1,600	0.010	1,600	0.010	1,200	0.010
20	0.7874	1,900	0.012	1,300	0.012	1,600	0.012	1,300	0.009	1,300	0.009	1,000	0.009

- 1) The table values are for drilling with water soluble cutting fluid.
- 2) DLC-HSS Drills are used in Nonferrous Metals such as Aluminum or Copper alloys.
- 3) Adjust drilling condition when unusual vibration or different sound occurs.
- 4) If drilling a deep hole over 3 times drill diameter, use pecking.

Screw Machine Length Bright



L561 General Purpose

Fractional: Range 3/64" to 2"
 Wire: Range #1 to #60
 Letter Range: A to Z

EDP	Size			Decimal Equivalent	Flute Length	Overall Length	EDP	Size			Decimal Equivalent	Flute Length	Overall Length	EDP	Size			Decimal Equivalent	Flute Length	Overall Length
	Fractional	Wire	Letter					Fractional	Wire	Letter					Fractional	Wire	Letter			
1061218		#60		0.0400	1/2	1 3/8	1004080		#11		0.1910	1 3/16	2 1/4	1265749	29/64		0.4531	2 1/8	3 9/16	
1061224		#59		0.0410			1061792		#10		0.1935			1265755	15/32		0.4688			2 3/16
1061230		#58		0.0420			1061808		#9		0.1960			1265761	31/64		0.4844	2 1/4	3 3/4	
1061247		#57		0.0430			1061814		#8		0.1990			1265778	1/2		0.5000			2 3/8
1061253		#56		0.0465			1061820		#7		0.2010			1265784	33/64		0.5156	2 1/2	4	
1265486	3/64			0.0469			1265589	13/64			0.2031			1265790	17/32		0.5313			2 5/8
1061276		#55		0.0520			1061843		#6		0.2040			1265806	35/64		0.5469	2 3/4	4 1/4	
1061282		#54		0.0550			1061850		#5		0.2055			1265812	9/16		0.5625			2 7/8
1061299		#53		0.0595			1061866		#4		0.2090			1265829	37/64		0.5781	3	4 3/4	
1265492	1/16			0.0625			1061872		#3		0.2130			1265835	19/32		0.5938			3 1/8
1061310		#52		0.0635	1265595	7/32			0.2188	1265841	39/64		0.6094	3 1/4	5 1/8					
1061327		#51		0.0670	1061895		#2		0.2210	1265858	5/8		0.6250			3 1/2	5 1/2			
1061333		#50		0.0700	1061900		#1		0.2285	1265864	41/64		0.6406	3 3/4	5 3/8					
1061340		#49		0.0730	1061917		A		0.2340	1265870	21/32		0.6563			3 5/8	5 5/8			
1061356		#48		0.0760	1265600	15/64			0.2344	1265887	43/64		0.6719	3 5/8	5 5/8					
1265508	5/64			0.0781	1061930		B		0.2380	1265893	11/16		0.6875			3 7/8	5 7/8			
1061379		#47		0.0785	1061946		C		0.2420	1265909	45/64		0.7031	4	6					
1061385		#46		0.0810	1061952		D		0.2460	1265915	23/32		0.7188			4 1/4	6 1/4			
1061391		#45		0.0820	1265617	1/4			0.2500	1265921	47/64		0.7344	4 1/4	6 1/4					
1061407		#44		0.0860	1061975		E		0.2500	1265938	3/4		0.7500			4 1/2	6 1/4			
1061413		#43		0.0890	1061981		F		0.2570	1265944	49/64		0.7656	4 1/2	6 1/4					
1061420		#42		0.0935	1061998		G		0.2610	1265950	25/32		0.7813			4 1/2	6 1/4			
1265514	3/32			0.0938	1265623	17/64			0.2656	1265967	51/64		0.7969	4 1/2	6 1/4					
1061442		#41		0.0960	1062019		H		0.2660	1265973	13/16		0.8125			4 1/2	6 1/4			
1061459		#40		0.0980	1062025		I		0.2720	1265980	53/64		0.8281	4 1/2	6 1/4					
1061465		#39		0.0995	1062031		J		0.2770	1265996	27/32		0.8438			4 1/2	6 1/4			
1061471		#38		0.1015	1062048		K		0.2810	1266000	55/64		0.8594	4 1/2	6 1/4					
1061488		#37		0.1040	1265630	9/32			0.2813	1266017	7/8		0.8750			4 1/2	6 1/4			
1061494		#36		0.1065	1062060		L		0.2900	1266023	57/64		0.8906	4 1/2	6 1/4					
1265520	7/64			0.1094	1062077		M		0.2950	1266030	29/32		0.9063			4 1/2	6 1/4			
1061516		#35		0.1100	1265646	19/64			0.2969	1266046	59/64		0.9219	4 1/2	6 1/4					
1061522		#34		0.1110	1062090		N		0.3020	1266052	15/16		0.9375			4 1/2	6 1/4			
1061539		#33		0.1130	1265652	5/16			0.3125	1266069	61/64		0.9531	4 1/2	6 1/4					
1061545		#32		0.1160	1062111		O		0.3160	1266075	31/32		0.9688			4 1/2	6 1/4			
1061551		#31		0.1200	1062128		P		0.3230	1266081	63/64		0.9844	4 1/2	6 1/4					
1265537	1/8			0.1250	1265669	21/64			0.3281	1266098	1		1.0000			4 1/2	6 1/4			
1061568		#30		0.1285	1062140		Q		0.3320	1266103	1 1/16		1.0625	4 1/2	6 1/4					
1061574		#29		0.1360	1062157		R		0.3390	1266110	1 1/8		1.1250			4 1/2	6 1/4			
1061580		#28		0.1405	1265675	11/32			0.3438	1266126	1 3/16		1.1875	4 1/2	6 1/4					
1265543	9/64			0.1406	1062170		S		0.3480	1266132	1 1/4		1.2500			4 1/2	6 1/4			
1061602		#27		0.1440	1062186		T		0.3580	1266149	1 5/16		1.3125	4 1/2	6 1/4					
1061619		#26		0.1470	1265681	23/64			0.3594	1266155	1 3/8		1.3750			4 1/2	6 1/4			
1061625		#25		0.1495	1062208		U		0.3680	1266161	1 7/16		1.4375	4 1/2	6 1/4					
1061631		#24		0.1520	1265698	3/8			0.3750	1266178	1 1/2		1.5000			4 1/2	6 1/4			
1061648		#23		0.1540	1062220		V		0.3770	1266184	1 9/16		1.5625	4 1/2	6 1/4					
1265550	5/32			0.1563	1062237		W		0.3860	1266190	1 5/8		1.6250			4 1/2	6 1/4			
1061660		#22		0.1570	1265703	25/64			0.3906	1266206	1 11/16		1.6875	4 1/2	6 1/4					
1061677		#21		0.1590	1062250		X		0.3970	1266212	1 3/4		1.7500			4 1/2	6 1/4			
1061683		#20		0.1610	1062266		Y		0.4040	1266229	1 13/16		1.8125	4 1/2	6 1/4					
1061690		#19		0.1660	1265710	13/32			0.4063	1266235	1 7/8		1.8750			4 1/2	6 1/4			
1061705		#18		0.1695	1062289		Z		0.4130	1266241	1 15/16		1.9375	4 1/2	6 1/4					
1265566	11/64			0.1719	1265726	27/64			0.4219	1266258	2		2.0000			4 1/2	6 1/4			
1061728		#17		0.1730	1265732	7/16			0.4375					4 1/2	6 1/4					
1061734		#16		0.1770												4 1/2	6 1/4			
1061740		#15		0.1800										4 1/2	6 1/4					
1061757		#14		0.1820												4 1/2	6 1/4			
1061763		#13		0.1850										4 1/2	6 1/4					
1265572	3/16			0.1875												4 1/2	6 1/4			
1061786		#12		0.1890										4 1/2	6 1/4					

Fractional sizes: Sizes 3/64 to 5/16 in package of 10; 21/64 to 1/2 in package of 5
 Wire gauge sizes: All sizes in package of 10
 Letter sizes: A to N in package of 10; O to Z in package of 5

Screw Machine Length Tin Coated



L561P General Purpose

Fractional: Range 1/16" to 1/2"
Wire: Range #1 to #52

HSS DRILLS

EDP	Size			Decimal Equivalent	Flute Length	Overall Length		
	Fractional	Wire	Letter					
1087629	1/16			0.0625	5/8	1 5/8		
1019049		#52		0.0635	11/16	1 11/16		
1019112		#51		0.0670				
1019215		#50		0.0700				
1019324		#49		0.0730				
1019347		#48		0.0760				
1087635	5/64			0.0781				
1019410		#47		0.0785				
1019433		#46		0.0810	3/4	1 3/4		
1019456		#45		0.0820				
1019520		#44		0.0860				
1019594		#43		0.0890				
1019651		#42		0.0935				
1087641	3/32			0.0938				
1019805		#41		0.0960			13/16	1 13/16
1019863		#40		0.0980				
1019892		#39		0.0995				
1020096		#38		0.1015				
1020124		#37		0.1040				
1020199		#36		0.1065				
1087658	7/64			0.1094				
1020371		#35		0.1100	7/8	1 7/8		
1020416		#34		0.1110				
1020468		#33		0.1130				
1020480		#32		0.1160				
1020502		#31		0.1200				
1087664	1/8			0.1250				
1020548		#30		0.1285			15/16	1 15/16
1020560		#29		0.1360				
1020583		#28		0.1405				
1087670	9/64			0.1406				
1020611		#27		0.1440	1	2 1/16		
1020634		#26		0.1470				
1020663		#25		0.1495				
1020708		#24		0.1520				
1020720		#23		0.1540				
1087687	5/32			0.1563				
1020795		#22		0.1570			1 1/16	2 1/8
1020846		#21		0.1590				
1020869		#20		0.1610				
1020898		#19		0.1660				

EDP	Size			Decimal Equivalent	Flute Length	Overall Length		
	Fractional	Wire	Letter					
1020961		#18		0.1695	1 1/16	2 1/8		
1087693	11/64			0.1719	1 1/8	2 3/16		
1021034		#17		0.1730				
1021092		#16		0.1770				
1021200		#15		0.1800				
1021230		#14		0.1820				
1021252		#13		0.1850				
1087709	3/16			0.1875				
1021303		#12		0.1890	1 3/16	2 1/4		
1021355		#11		0.1910				
1021493		#10		0.1935				
1021521		#9		0.1960				
1021567		#8		0.1990				
1021601		#7		0.2010				
1087715	13/64			0.2031			1 1/4	2 3/8
1021653		#6		0.2040				
1021676		#5		0.2055				
1021699		#4		0.2090				
1021710		#3		0.2130				
1087721	7/32			0.2188				
1021762		#2		0.2210	1 5/16	2 7/16		
1021791		#1		0.2285				
1087738	15/64			0.2344				
1087744	1/4			0.2500			1 3/8	2 1/2
1087750	17/64			0.2656			1 7/16	2 5/8
1087767	9/32			0.2813			1 1/2	2 11/16
1087773	19/64			0.2969			1 9/16	2 3/4
1087780	5/16			0.3125	1 5/8	2 13/16		
1087796	21/64			0.3281	1 11/16	2 15/16		
1087801	11/32			0.3438		3		
1087818	23/64			0.3594	1 3/4	3 1/16		
1087824	3/8			0.3750	1 13/16	3 1/8		
1087830	25/64			0.3906	1 7/8	3 1/4		
1087847	13/32			0.4063	1 15/16	3 5/16		
1087853	27/64			0.4219	2	3 3/8		
1087860	7/16			0.4375	2 1/16	3 7/16		
1087876	29/64			0.4531	2 1/8	3 9/16		
1087882	15/32			0.4688		3 5/8		
1087899	31/64			0.4844	2 3/16	3 11/16		
1087904	1/2			0.5000	2 1/4	3 3/4		

Fractional sizes: Sizes 3/64 to 5/16 in package of 10; 21/64 to 1/2 in package of 5
Wire gauge sizes: All sizes in package of 10

Screw Machine Length Aircraft



L563 Aircraft NAS907-C - Black Oxide

Fractional: Bright Finish 3/64 to 7/64 Black Oxide 1/8 to 1/2
 Wire: Bright Finish #32 to #52 Black Oxide #1 to #31
 Letter: Range A to Z

EDP	Size			Decimal Equivalent	Flute Length	Overall Length
	Fractional	Wire	Letter			
1050626	3/64			0.0469	1/2	1 3/8
1050632	1/16			0.0625	5/8	1 5/8
1050649		#52		0.0635	11/16	1 11/16
1050655		#51		0.0670		
1050661		#50		0.0700		
1050678		#49		0.0730		
1050684		#48		0.0760		
1050690	5/64			0.0781	3/4	1 3/4
1050706		#47		0.0785		
1050712		#46		0.0810		
1050729		#45		0.0820		
1050735		#44		0.0860		
1050741		#43		0.0890	13/16	1 13/16
1050758		#42		0.0935		
1050764	3/32			0.0938		
1050770		#41		0.0960		
1050787		#40		0.0980		
1050793		#39		0.0995	7/8	1 7/8
1050809		#38		0.1015		
1050815		#37		0.1040		
1050821		#36		0.1065		
1050838	7/64			0.1094		
1050844		#35		0.1100	15/16	1 15/16
1050850		#34		0.1110		
1050867		#33		0.1130		
1050873		#32		0.1160		
1050880		#31		0.1200		
1050896	1/8			0.1250	1	2 1/16
1050901		#30		0.1285		
1050912		#29		0.1360		
1050918		#28		0.1405		
1050924	9/64			0.1406		
1050930		#27		0.1440	1 1/16	2 1/8
1050947		#26		0.1470		
1050953		#25		0.1495		
1050960		#24		0.1520		
1050976		#23		0.1540		
1059829	5/32			0.1563	1 1/8	2 3/16
1050982		#22		0.1570		
1050999		#21		0.1590		
1059835		#20		0.1610		
1051003		#19		0.1660		
1051010		#18		0.1695	1 3/16	2 1/4
1059841	11/64			0.1719		
1051026		#17		0.1730		
1051032		#16		0.1770		
1051049		#15		0.1800		
1051055		#14		0.1820	1 3/16	2 1/4
1051061		#13		0.1850		
1051078	3/16			0.1875		
1051084		#12		0.1890		
1051090		#11		0.1910		
1051106		#10		0.1935	1 3/16	2 1/4
1051112		#9		0.1960		

EDP	Size			Decimal Equivalent	Flute Length	Overall Length
	Fractional	Wire	Letter			
1051129		#8		0.1990	1 3/16	2 1/4
1051135		#7		0.2010		
1059858	13/64			0.2031	1 1/4	2 3/8
1051141		#6		0.2040		
1051158		#5		0.2055		
1051164		#4		0.2090		
1051170		#3		0.2130		
1051187	7/32			0.2188	1 5/16	2 7/16
1051193		#2		0.2210		
1051209		#1		0.2285		
1051215			A	0.2340		
1051221	15/64			0.2344		
1051238			B	0.2380	1 3/8	2 1/2
1051244			C	0.2420		
1051250			D	0.2460		
1051267	1/4			0.2500		
1051273			E	0.2500		
1051280			F	0.2570	1 7/16	2 5/8
1051296			G	0.2610		
1051301	17/64			0.2656		
1059864			H	0.2660		
1051318			I	0.2720		
1051324			J	0.2770		
1051330			K	0.2810		
1051347	9/32			0.2813		
1051353			L	0.2900		
1051360			M	0.2950	1 9/16	2 3/4
1051376	19/64			0.2969		
1051382			N	0.3020		
1051399	5/16			0.3125		
1051404			O	0.3160		
1051410			P	0.3230	1 11/16	2 15/16
1051427	21/64			0.3281		
1051433			Q	0.3320		
1051440			R	0.3390		
1051456	11/32			0.3438		
1051462			S	0.3480	1 3/4	3 1/16
1051479			T	0.3580		
1051485	23/64			0.3594		
1051491			U	0.3680		
1059870	3/8			0.3750		
1051507			V	0.3770	1 7/8	3 1/4
1051513			W	0.3860		
1051520	25/64			0.3906		
1051536			X	0.3970		
1051542			Y	0.4040		
1051559	13/32			0.4063	1 15/16	3 5/16
1051565			Z	0.4130		
1051571	27/64			0.4219		
1051588	7/16			0.4375		
1051594	29/64			0.4531		
1051600	15/32			0.4688	2 1/8	3 5/8
1051616	31/64			0.4844		
1051622	1/2			0.5000	2 1/4	3 3/4

Fractional sizes: Sizes 3/64 to 5/16 in package of 10; 21/64 to 1/2 in package of 5
 Wire gauge sizes: All sizes in package of 10
 Letter sizes: A to N in package of 10; O to Z in package of 5

Screw Machine Length Cobalt



L6563 Aircraft NAS907-C - Cobalt

Fractional: Bright Finish 3/64 to 7/64 Black Oxide 1/8 to 1/2

Wire: Bright Finish #32 to #52 Black Oxide #1 to #31

Letter: Range A to Z

HSS DRILLS

EDP	Size			Decimal Equivalent	Flute Length	Overall Length	EDP	Size			Decimal Equivalent	Flute Length	Overall Length	EDP	Size			Decimal Equivalent	Flute Length	Overall Length
	Fractional	Wire	Letter					Fractional	Wire	Letter					Fractional	Wire	Letter			
1080704	3/64			0.0469	1/2	1 3/8	1080779	5/32			0.1563	1	2 1/8	1081060			H	0.2660		
1080710	1/16			0.0625	5/8	1 5/8	1081557		#22		0.1570			1081076			I	0.2720	1 1/2	2 11/16
1081259		#52		0.0635			1081563		#21		0.1590			1081082			J	0.2770		
1081265		#51		0.0670			1081570		#20		0.1610			1081099			K	0.2810		
1081271		#50		0.0700	11/16	1 11/16	1081586		#19		0.1660	1 1/16	2 1/8	1080859	9/32			0.2813		
1081288		#49		0.0730			1081592		#18		0.1695			1081104			L	0.2900		
1081294		#48		0.0760			1080785	11/64			0.1719			1081110			M	0.2950	1 9/16	2 3/4
1080727	5/64			0.0781			1081608		#17		0.1730			1080865	19/64			0.2969		
1081300		#47		0.0785			1081614		#16		0.1770			1081127			N	0.3020	1 5/8	2 13/16
1081316		#46		0.0810			1081620		#15		0.1800	1 1/8	2 3/16	1080871	5/16			0.3125		
1081322		#45		0.0820			1081637		#14		0.1820			1081133			O	0.3160		
1081339		#44		0.0860	3/4	1 3/4	1081643		#13		0.1850			1081140			P	0.3230		2 15/16
1081345		#43		0.0890			1080791	3/16			0.1875			1080888	21/64	3/16		0.3281	1 11/16	
1081351		#42		0.0935			1081650		#12		0.1890			1081156			Q	0.3320		
1080733	3/32			0.0938			1081666		#11		0.1910			1081162			R	0.3390		3
1081368		#41		0.0960			1081672		#10		0.1935			1080894	11/32			0.3438		
1081374		#40		0.0980			1081689		#9		0.1960	1 3/16	2 1/4	1081179			S	0.3480		
1081380		#39		0.0995			1081695		#8		0.1990			1081185			T	0.3580	1 3/4	3 1/16
1081397		#38		0.1015	13/16	1 13/16	1081700		#7		0.2010			1080900	23/64			0.3594		
1081402		#37		0.1040			1080807	13/64			0.2031			1081191			U	0.3680	1 13/16	3 1/8
1081419		#36		0.1065			1081717		#6		0.2040			1080916	3/8			0.3750		
1080740	7/64			0.1094			1081723		#5		0.2055			1081207			V	0.3770		
1081425		#35		0.1100			1081730		#4		0.2090	1 1/4	2 3/8	1081213			W	0.3860	1 7/8	3 1/4
1081431		#34		0.1110			1081746		#3		0.2130			1080922	25/64			0.3906		
1081448		#33		0.1130	7/8	1 7/8	1080813	7/32			0.2188			1081220			X	0.3970		
1081454		#32		0.1160			1081752		#2		0.2210			1081236			Y	0.4040	1 15/16	3 5/16
1081460		#31		0.1200			1081769		#1		0.2285			1080939	13/32			0.4063		
1080756	1/8			0.1250			1081001			A	0.2340		1 5/16	1081242			Z	0.4130	2	3 3/8
1081477		#30		0.1285			1080820	15/64			0.2344			1080945	27/64			0.4219		
1081483		#29		0.1360	15/16	1 15/16	1081018			B	0.2380			1080951	7/16			0.4375	2 1/16	3 7/16
1081490		#28		0.1405			1081024			C	0.2420			1080968	29/64			0.4531	2 1/8	3 9/16
1080762	9/64			0.1406			1146978			D	0.2460	1 3/8	2 1/2	1080974	15/32			0.4688		3 5/8
1081505		#27		0.1440			1080836	1/4			0.2500			1080980	31/64			0.4844	2 3/16	3 11/16
1081511		#26		0.1470			1081030			E	0.2500			1080997	1/2			0.5000	2 1/4	3 3/4
1081528		#25		0.1495	1	2 1/16	1081047			F	0.2570									
1081534		#24		0.1520			1081053			G	0.2610	1 7/16	2 5/8							
1081540		#23		0.1540			1080842	17/64			0.2656									

Fractional sizes: Sizes 3/64 to 5/16 in package of 10; 21/64 to 1/2 in package of 5

Wire gauge sizes: All sizes in package of 10

Letter sizes: A to N in package of 10; O to Z in package of 5

WARNING: Cancer - www.P65Warnings.ca.gov

Straight Shank Jobber Length Bright



L501A General Purpose

Fractional: Range 1/64" to 11/16"

Wire: Range #1 to #80

Letter: Range A to Z

EDP	Size			Decimal Equivalent	Flute Length	Overall Length	EDP	Size			Decimal Equivalent	Flute Length	Overall Length	EDP	Size			Decimal Equivalent	Flute Length	Overall Length
	Fractional	Wire	Letter					Fractional	Wire	Letter					Fractional	Wire	Letter			
0010870		#80		0.0135	1/8	3/4	0545332		#36		0.1065	1 7/16	2 1/2	0545733			E	0.2500	2 3/4	4
0010886		#79		0.0145	3/16	7/8	0543638	7/64			0.1094	1 1/2	2 5/8	0545740			F	0.2570	2 7/8	4 1/8
0010892	1/64			0.0156			0545349		#35		0.1100			0545756			G	0.2610		
0010908		#78		0.0160	1/4	1	0545355		#34		0.1110	1 5/8	2 3/4	0543730	17/64			0.2656	2 15/16	4 1/4
0010914		#77		0.0180			0545361		#33		0.1130			0545762			H	0.2660		
0010920		#76		0.0200	5/16	1 1/8	0545378		#32		0.1160	1 3/4	2 7/8	0545779			I	0.2720	3 1/16	4 3/8
0010937		#75		0.0210			0545384		#31		0.1200			0545785			J	0.2770		
0010943		#74		0.0225	3/8	1 1/4	0543644	1/8			0.1250	1 7/8	3	0545791			K	0.2810	3 3/16	4 1/2
0010950		#73		0.0240			0545390		#30		0.1285			0543747	9/32					
0010966		#72		0.0250	11/16	1 5/8	0545406		#29		0.1360	2	3 1/8	0545807			L	0.2900	3 5/8	5
0010972		#71		0.0260			0545412		#28		0.1405			0545813			M	0.2950		
0010989		#70		0.0280	3/4	1 3/4	0543650	9/64			0.1406	2 1/8	3 1/4	0543753	19/64			0.2969	4 1/2	5 1/8
0010995		#69		0.0292			0545429		#27		0.1440			0545820			N	0.3020		
0011000		#68		0.0310	5/8	1 1/2	0545435		#26		0.1470	2 3/16	3 3/8	0543760	5/16			0.3125	4 3/4	5 3/8
0011016	1/32			0.0313			0545441		#25		0.1495			0545836			O	0.3160		
0011022		#67		0.0320	7/8	1 7/8	0545458		#24		0.1520	2 1/2	3 1/2	0545842			P	0.3230	4 5/8	5 3/4
0011039		#66		0.0330			0545464		#23		0.1540			0543776	21/64					
0011045		#65		0.0350	1	2	0543667	5/32			0.1563	2 7/16	3 5/8	0545859			Q	0.3320	5 1/2	6
0011051		#64		0.0360			0545470		#22		0.1570			0545865			R	0.3390		
0011068		#63		0.0370	1 1/8	2 1/8	0545487		#21		0.1590	2 1/2	3 3/4	0543782	11/32			0.3438	6 1/8	7 1/8
0011074		#62		0.0380			0545493		#20		0.1610			0545871			S	0.3480		
0011080		#61		0.0390	1 1/4	2 1/4	0545509		#19		0.1660	2 3/4	3 7/8	0545888			T	0.3580	7 1/4	8 1/4
0545092		#60		0.0400			0545515		#18		0.1695			0543799	23/64					
0545108		#59		0.0410	1 3/4	2 1/4	0543673	11/64			0.1719	2 3/4	3 1/2	0545894			U	0.3680	8 1/4	9 1/4
0545114		#58		0.0420			0545521		#17		0.1730			0543804	3/8					
0545120		#57		0.0430	1 3/8	2 3/8	0545538		#16		0.1700	2 3/4	3 1/2	0545900			V	0.3770	9 1/4	10 1/4
0545137		#56		0.0465			0545544		#15		0.1800			0545916			W	0.3860		
0543593	3/64			0.0469	1 1/2	2 1/4	0545550		#14		0.1820	2 3/4	3 1/2	0543810	25/64			0.3906	10 1/4	11 1/4
0545143		#55		0.0520			0545567		#13		0.1850			0545922			X	0.3970		
0545150		#54		0.0550	1 3/4	2 3/4	0543680	3/16			0.1875	2 3/4	3 1/2	0545939			Y	0.4040	11 1/4	12 1/4
0545166		#53		0.0595			0545573		#12		0.1890			0543827	13/32					
0543609	1/16			0.0625	1 3/8	2 3/8	0545580		#11		0.1910	2 3/4	3 1/2	0545945			Z	0.4130	12 1/4	13 1/4
0545172		#52		0.0635			0545596		#10		0.1935			0543833	27/64					
0545189		#51		0.0670	1 1/2	2 1/2	0545601		#9		0.1960	2 3/4	3 1/2	0543840	7/16			0.4375	13 1/4	14 1/4
0545195		#50		0.0700			0545618		#8		0.1990			0543856	29/64					
0545200		#49		0.0730	1 3/8	2 3/8	0545624		#7		0.2010	2 3/4	3 1/2	0543862	15/32			0.4688	14 1/4	15 1/4
0545217		#48		0.0760			0543696	13/64			0.2031			0543879	31/64					
0543615	5/64			0.0781	1 1/4	2 1/4	0545630		#6		0.2040	2 3/4	3 1/2	0543885	1/2			0.5000	15 1/4	16 1/4
0545223		#47		0.0785			0545647		#5		0.2055			1131784	33/64					
0545230		#46		0.0810	1 1/8	2 1/8	0545653		#4		0.2090	2 3/4	3 1/2	1131790	17/32			0.5313	16 1/4	17 1/4
0545246		#45		0.0820			0545660		#3		0.2130			1131806	35/64					
0545252		#44		0.0860	1 1/8	2 1/8	0543701	7/32			0.2188	2 3/4	3 1/2	1131812	9/16			0.5625	17 1/4	18 1/4
0545269		#43		0.0890			0545676		#2		0.2210			1131829	37/64					
0545275		#42		0.0935	1 3/8	2 3/8	0545682		#1		0.2280	2 3/4	3 1/2	1131835	19/32			0.5938	18 1/4	19 1/4
0543621	3/32			0.0938			0545699			A	0.2340			1131841	39/64					
0545281		#41		0.0960	1 1/4	2 1/4	0543718	15/64			0.2344	2 3/4	3 1/2	1131858	5/8			0.6250	19 1/4	20 1/4
0545298		#40		0.0980			0545704			B	0.2380			1131864	41/64					
0545303		#39		0.0995	1 3/8	2 3/8	0545710				0.2420	2 3/4	3 1/2	1131870	21/32			0.6563	20 1/4	21 1/4
0545310		#38		0.1015			0545727			C	0.2460			1131887	43/64					
0545326		#37		0.1040	1 7/16	2 1/2	0543724	1/4			0.2500			1131893	11/16			0.6875	21 1/4	22 1/4

Fractional sizes: Sizes 1/64 to 5/16 in package of 10; 21/64 to 1/2 in package of 5; 33/64 to 11/16 in package of 2

Wire gauge sizes: All sizes in package of 10

Letter sizes: A to N in package of 10; O to Z in package of 5

Straight Shank Jobber Length



L500 General Purpose, Metric

Bright Finish 0.2 to 1.95 mm
Black Oxide 2.0 to 17.5 mm

(Unit) : mm

EDP	Size	Decimal Equivalent	Flute Length	Overall Length	EDP	Size	Decimal Equivalent	Flute Length	Overall Length	EDP	Size	Decimal Equivalent	Flute Length	Overall Length					
0121256	0.2000	0.0079	3	19	0004333	2.8000	0.1102	39	67	0004917	7.5000	0.2953	78	111					
0345266	0.2200	0.0087	3.5	20	0156256	2.8500	0.1122	42	71	0004930	7.6000	0.2992	81	114					
0062423	0.2500	0.0098			0004340	2.9000	0.1142			0004946	7.7000	0.3031							
0345403	0.2800	0.0110			0159123	2.9500	0.1161			0141194	7.7500	0.3051							
0062417	0.3000	0.0118	5.5	24	0004356	3.0000	0.1181	45	73	0004952	7.8000	0.3071	84	117					
0345478	0.3200	0.0126			0004362	3.1000	0.1220			0004969	7.9000	0.3110							
0062400	0.3500	0.0138			0004385	3.2000	0.1260			0004981	8.0000	0.3150							
0345570	0.3800	0.0150	7.5	27	0159713	3.2500	0.1280	48	76	0004998	8.1000	0.3189	87	121					
0062395	0.4000	0.0157			0004391	3.3000	0.1299			0005002	8.2000	0.3228							
0346474	0.4200	0.0165			0004407	3.4000	0.1339			0142957	8.2500	0.3248							
0062389	0.4500	0.0177	8.5	30	0118957	3.5000	0.1378	51	79	0005019	8.3000	0.3268	89	124					
0346560	0.4800	0.0189			0004436	3.6000	0.1417			0005031	8.4000	0.3307							
0062372	0.5000	0.0197			0004442	3.7000	0.1457			0005048	8.5000	0.3346							
0062366	0.5500	0.0217	10	32	0159880	3.7500	0.1476	54	83	0005054	8.6000	0.3386	92	127					
0062350	0.6000	0.0236			0004459	3.8000	0.1496			0005060	8.7000	0.3425							
0062343	0.6500	0.0256			0004465	3.9000	0.1535			0143151	8.7500	0.3445							
0062337	0.7000	0.0276	11	34	0004488	4.0000	0.1575	56	86	0005083	8.8000	0.3465	95	130					
0062320	0.7500	0.0295			0004494	4.1000	0.1614			0005090	8.9000	0.3504							
0062314	0.8000	0.0315			0004500	4.2000	0.1654			0005105	9.0000	0.3543							
0062308	0.8500	0.0335	13	36	0159931	4.2500	0.1673	59	89	0005111	9.1000	0.3583	103	140					
0062292	0.9000	0.0354			0004516	4.3000	0.1693			0005134	9.2000	0.3622							
0062286	0.9500	0.0374			0004539	4.4000	0.1732			0143517	9.2500	0.3642							
0062270	1.0000	0.0394	18	40	0004545	4.5000	0.1772	62	92	0005140	9.3000	0.3661	106	143					
0128870	1.0500	0.0413			0004551	4.6000	0.1811			0005157	9.4000	0.3701							
0062263	1.1000	0.0433			0004568	4.7000	0.1850			0005163	9.5000	0.3740							
0129641	1.1500	0.0453	20	42	0160090	4.7500	0.1870	64	95	0005192	9.7000	0.3819	109	146					
0062257	1.2000	0.0472			0004580	4.8000	0.1890			0005214	9.9000	0.3898							
0130298	1.2500	0.0492			0004597	4.9000	0.1929			0005237	10.0000	0.3937							
0062240	1.3000	0.0512	22	45	0004602	5.0000	0.1969	66	97	0005250	10.2000	0.4016	111	149					
0131271	1.3500	0.0531			0004619	5.1000	0.2008			0005295	10.5000	0.4134							
0062234	1.4000	0.0551			0160347	5.2500	0.2067			0144651	10.7500	0.4232							
0132473	1.4500	0.0571	23	48	0004648	5.3000	0.2087	67	98	0005330	10.8000	0.4252	114	152					
0062228	1.5000	0.0591			0004654	5.4000	0.2126			0005352	11.0000	0.4331							
0133280	1.5500	0.0610			0004660	5.5000	0.2165			0005381	11.2000	0.4409							
0062211	1.6000	0.0630	25	50	0004683	5.6000	0.2205	70	102	0145074	11.2500	0.4429	118	158					
0134098	1.6500	0.0650			0004690	5.7000	0.2244			0005410	11.5000	0.4528							
0062205	1.7000	0.0669			0160600	5.7500	0.2264			0145635	11.7500	0.4626							
0135254	1.7500	0.0689	28	52	0004705	5.8000	0.2283	73	105	0005455	11.8000	0.4646	122	168					
0062190	1.8000	0.0709			0004711	5.9000	0.2323			0005541	12.5000	0.4921							
0136870	1.8500	0.0728			0004734	6.0000	0.2362			0147804	12.7500	0.5020							
0062183	1.9000	0.0748	29	55	0004740	6.1000	0.2402	75	108	0005587	12.8000	0.5039	127	174					
0138728	1.9500	0.0768			0004757	6.2000	0.2441			0005609	13.0000	0.5118							
0004230	2.0000	0.0787			0140640	6.2500	0.2461			0005615	13.5000	0.5315							
0139856	2.0500	0.0807	30	58	0004763	6.3000	0.2480	77	110	0005638	14.0000	0.5512	131	181					
0004247	2.1000	0.0827			0004786	6.4000	0.2520			0005644	14.5000	0.5709							
0143632	2.1500	0.0846			0004792	6.5000	0.2559			0005650	15.0000	0.5906							
0004253	2.2000	0.0866	33	58	0004808	6.6000	0.2598	79	113	0005667	15.5000	0.6102	135	185					
0144536	2.2500	0.0886			0004814	6.7000	0.2638			0005673	16.0000	0.6299							
0004260	2.3000	0.0906			0140713	6.7500	0.2657			0005680	16.5000	0.6496							
0146385	2.3500	0.0925	35	61	0004837	6.8000	0.2677	81	115	0005701	17.0000	0.6693	139	189					
0004282	2.4000	0.0945			0004843	6.9000	0.2717			0005718	17.5000	0.6890							
0147810	2.4500	0.0965			0004850	7.0000	0.2756												
0004299	2.5000	0.0984	37	64	0004866	7.1000	0.2795	83	117				141	191					
0149355	2.5500	0.1004			0004889	7.2000	0.2835												
0004304	2.6000	0.1024			0140977	7.2500	0.2854												
0151450	2.6500	0.1043	39	67	0004895	7.3000	0.2874	85	119				143	193					
0004310	2.7000	0.1063			0004900	7.4000	0.2913												
0152995	2.7500	0.1083																	

0.2 to 8.0 in package of 10; 8.1 to 13.0 in package of 5; 13.5 to 17.50 in package of 2

Straight Shank Jobber Length



L501 General Purpose, Fractional, Wire & Letter

Fractional: Bright Finish 3/64 to 7/64 Black Oxide 1/8 to 11/16
 Wire: Bright Finish #32 to #60 Black Oxide #1 to #31
 Letter: Range A to Z

EDP	Size			Decimal Equivalent	Flute Length	Overall Length	EDP	Size			Decimal Equivalent	Flute Length	Overall Length	EDP	Size			Decimal Equivalent	Flute Length	Overall Length
	Fractional	Wire	Letter					Fractional	Wire	Letter					Fractional	Wire	Letter			
0011097		#60		0.0400			0011526		#24		0.1520			0011847	9/32			0.2813	2 15/16	4 1/4
0011102		#59		0.0410	11/16	1 5/8	0011532		#23		0.1540		2	0553945			L	0.2900		
0011119		#58		0.0420			0011549	5/32			0.1563			0553951			M	0.2950		
0011125		#57		0.0430			0011555		#22		0.1570			0011853	19/64			0.2969	3 1/16	4 3/8
0011131		#56		0.0465	3/4	1 3/4	0011561		#21		0.1590			0553968			N	0.3020		
0011148	3/64			0.0469			0011578		#20		0.1610			0011860	5/16			0.3125	3 3/16	4 1/2
0011154		#55		0.0520			0011584		#19		0.1660	2 1/8	3 1/4	0553974			O	0.3160		
0011160		#54		0.0550			0011590		#18		0.1695			0553980			P	0.3230	3 5/16	4 5/8
0011177		#53		0.0595	7/8	1 7/8	0011606	11/64			0.1719			0011876	21/64			0.3281		
0011183	1/16			0.0625			0011629		#17		0.1730			0553997			Q	0.3320		
0011190		#52		0.0635			0011612		#16		0.1700	2 3/16	3 3/8	0554001			R	0.3390	3 7/16	4 3/4
0011205		#51		0.0670			0011635		#15		0.1800			0011882	11/32			0.3438		
0011211		#50		0.0700			0011641		#14		0.1820			0554018			S	0.3480		
0011228		#49		0.0730	1	2	0011658		#13		0.1850			0554024			T	0.3580	3 1/2	4 7/8
0011234		#48		0.0760			0011664	3/16			0.1875			0011899	23/64			0.3594		
0011240	5/64			0.0781			0011670		#12		0.1890	2 5/16	3 1/2	0554030			U	0.3680		
0011257		#47		0.0785			0011687		#11		0.1910			0011904	3/8			0.3750	3 5/8	5
0011263		#46		0.0810			0011693		#10		0.1935			0554047			V	0.3770		
0011270		#45		0.0820	1 1/8	2 1/8	0011709		#9		0.1960			0554053			W	0.3860		
0011286		#44		0.0860			0011715		#8		0.1990	2 7/16	3 5/8	0011910	25/64			0.3906	3 3/4	5 1/8
0011292		#43		0.0890			0011721		#7		0.2010			0554060			X	0.3970		
0011308		#42		0.0935	1 1/4	2 1/4	0011738	13/64			0.2031			0554076			Y	0.4040		
0011314	3/32			0.0938			0011744		#6		0.2040			0011927	13/32			0.4063	3 7/8	5 1/4
0011320		#41		0.0960			0011750		#5		0.2055			0554082			Z	0.4130		
0590530		#40		0.0980	1 3/8	2 3/8	0011767		#4		0.2090	2 1/2	3 3/4	0011933	27/64			0.4219	3 15/16	5 3/8
0011343		#39		0.0995			0011773		#3		0.2130			0011940	7/16			0.4375	4 1/16	5 1/2
0011350		#38		0.1015			0011780	7/32			0.2188			0011956	29/64			0.4531	4 3/16	5 5/8
0011366		#37		0.1040	1 7/16	2 1/2	0011796		#2		0.2210			0011962	15/32			0.4688	4 5/16	5 3/4
0011372		#36		0.1065			0011801		#1		0.2280	2 5/8	3 7/8	0011979	31/64			0.4844	4 3/8	5 7/8
0011389	7/64			0.1094			0553836		A		0.2340			0011985	1/2			0.5000	4 1/2	6
0011395		#35		0.1100			0011818	15/64			0.2344			1131669	33/64			0.5156		
0011400		#34		0.1110	1 1/2	2 5/8	0553842		B		0.2380			1131675	17/32			0.5313		
0011417		#33		0.1130			0553859		C		0.2420			1131681	35/64			0.5469	4 13/16	6 5/8
0011423		#32		0.1160			0553865		D		0.2460	2 3/4	4	1131698	9/16			0.5625		
0011430		#31		0.1200	1 5/8	2 3/4	0553871		E		0.2500			1131703	37/64			0.5781		
0011446	1/8			0.1250			0011824	1/4			0.2500			1131710	19/32			0.5938		
0011452		#30		0.1285			0553888		F		0.2570			1131726	39/64			0.6094		
0011469		#29		0.1360			0553894		G		0.2610			1131732	5/8			0.6250	5 3/16	7 1/8
0011475		#28		0.1405	1 3/4	2 7/8	0011830	17/64			0.2656			1131749	41/64			0.6406		
0011481	9/64			0.1406			0553900		H		0.2660	2 7/8	4 1/8	1131755	21/32			0.6563		
0011498		#27		0.1440			0553916		I		0.2720			1131761	43/64			0.6719	5 5/8	7 5/8
0011503		#26		0.1470	1 7/8	3	0553922		J		0.2770			1131778	11/16			0.6875		
0011510		#25		0.1495			0553939		K		0.2810	2 15/16	4 1/4							

Fractional sizes: Sizes 1/64 to 5/16 in package of 10; 21/64 to 1/2 in package of 5; 33/64 to 11/16 in package of 2
 Wire gauge sizes: All sizes in package of 10
 Letter sizes: A to N in package of 10; O to Z in package of 5

Straight Shank Jobber Length Aircraft



L6501 Aircraft NAS907-J, Fractional, Wire & Letter

Fractional: Bright Finish 1/64 to 7/64 Black Oxide 1/8 to 1/2
 Wire: Bright Finish #32 to #80 Black Oxide #1 to #31
 Letter: Range A to Z

HSS DRILLS

EDP	Size			Decimal Equivalent	Flute Length	Overall Length	EDP	Size			Decimal Equivalent	Flute Length	Overall Length	EDP	Size			Decimal Equivalent	Flute Length	Overall Length
	Fractional	Wire	Letter					Fractional	Wire	Letter					Fractional	Wire	Letter			
1056762		#80		0.0135	1/8	3/4	1060154	#40		0.0980	1 3/8	2 3/8	1060606	#2		0.2210				
1056779		#79		0.0145			1060160	#39		0.0995			1060612	#1		0.2280	2 5/8	3 7/8		
1056785	1/64			0.0156			1060177	#38		0.1015			1054054		A	0.2340				
1056791		#78		0.0160			1060183	#37		0.1040	1 7/16	2 1/2	1060629	15/64		0.2344				
1056807		#77		0.0180	3/16	7/8	1060190	#36		0.1065			1054077		B	0.2380				
1056813		#76		0.0200			1053969	7/64		0.1094			1054083		C	0.2420				
1056820		#75		0.0210	1/4	1	1060205	#35		0.1100	1 1/2	2 5/8	1054090		D	0.2460	2 3/4	4		
1056836		#74		0.0225			1060211	#34		0.1110			1060635	1/4		0.2500				
1056842		#73		0.0240	5/16	1 1/8	1060228	#33		0.1130			1054111		E	0.2500				
1056865		#72		0.0250			1060234	#32		0.1160			1054128		F	0.2570				
1056859		#71		0.0260	3/8	1 1/4	1060240	#31		0.1200	1 5/8	2 3/4	1054134		G	0.2610				
1056871		#70		0.0280			1060257	1/8		0.1250			1060641	17/64		0.2656	2 7/8	4 1/8		
1056888		#69		0.0292			1060263	#30		0.1285			1054157		H	0.2660				
1056894		#68		0.0310			1060270	#29		0.1360			1054163		I	0.2720				
1056900	1/32			0.0313	1/2	1 3/8	1060286	#28		0.1405	1 3/4	2 7/8	1054170		J	0.2770				
1056916		#67		0.0320			1060292	9/64		0.1406			1054186		K	0.2810				
1056922		#66		0.0330			1060308	#27		0.1440			1060658	9/32		0.2813	2 15/16	4 1/4		
1056939		#65		0.0350			1060314	#26		0.1470	1 7/8	3	1054208		L	0.2900				
1056945		#64		0.0360	5/8	1 1/2	1060320	#25		0.1495			1054214		M	0.2950				
1056951		#63		0.0370			1060337	#24		0.1520			1060664	19/64		0.2969	3 1/16	4 3/8		
1056968		#62		0.0380			1060343	#23		0.1540	2	3 1/8	1054237		N	0.3020				
1053889		#61		0.0390			1060350	5/32		0.1563			1060670	5/16		0.3125	3 3/16	4 1/2		
1059950		#60		0.0400	11/16	1 5/8	1060366	#22		0.1570			1054250		O	0.3160				
1059967		#59		0.0410			1060372	#21		0.1590			1054266		P	0.3230				
1059973		#58		0.0420			1060389	#20		0.1610			1060687	21/64		0.3281				
1059980		#57		0.0430			1060395	#19		0.1660	2 1/8	3 1/4	1054289		Q	0.3320				
1059996		#56		0.0465	3/4	1 3/4	1060400	#18		0.1695			1054295		R	0.3390	3 7/16	4 3/4		
1053895	3/64			0.0469			1060417	11/64		0.1719			1060693	11/32		0.3438				
1060000		#55		0.0520			1060423	#17		0.1730			1054317		S	0.3480				
1060016		#54		0.0550			1060430	#16		0.1700	2 3/16	3 3/8	1054323		T	0.3580	3 1/2	4 7/8		
1060022		#53		0.0595	7/8	1 7/8	1060446	#15		0.1800			1060709	23/64		0.3594				
1053900	1/16			0.0625			1060452	#14		0.1820			1054346		U	0.3680				
1060039		#52		0.0635			1060469	#13		0.1850			1060715	3/8		0.3750	3 5/8	5		
1060045		#51		0.0670			1060475	3/16		0.1875	2 5/16	3 1/2	1054369		V	0.3770				
1060051		#50		0.0700			1060481	#12		0.1890			1054375		W	0.3860				
1060068		#49		0.0730	1	2	1060498	#11		0.1910			1060721	25/64		0.3906	3 3/4	5 1/8		
1060074		#48		0.0760			1060503	#10		0.1935			1054398		X	0.3970				
1053923	5/64			0.0781			1060510	#9		0.1960			1054403		Y	0.4040				
1060080		#47		0.0785			1060526	#8		0.1990	2 7/16	3 5/8	1060738	13/32		0.4063	3 7/8	5 1/4		
1060097		#46		0.0810			1060532	#7		0.2010			1054426		Z	0.4130				
1060102		#45		0.0820	1 1/8	2 1/8	1060549	13/64		0.2031			1060744	27/64		0.4219	3 15/16	5 3/8		
1060119		#44		0.0860			1060555	#6		0.2040			1060750	7/16		0.4375	4 1/16	5 1/2		
1060125		#43		0.0890			1060561	#5		0.2055			1060767	29/64		0.4531	4 3/16	5 5/8		
1060131		#42		0.0935	1 1/4	2 1/4	1060578	#4		0.2090	2 1/2	3 3/4	1060773	15/32		0.4688	4 5/16	5 3/4		
1053946	3/32			0.0938			1060584	#3		0.2130			1060780	31/64		0.4844	4 3/8	5 7/8		
1060148		#41		0.0960	1 3/8	2 3/8	1060590	7/32		0.2188			1060796	1/2		0.5000	4 1/2	6		

Fractional sizes: Sizes 1/64 to 5/16 in package of 10; 21/64 to 1/2 in package of 5; 33/64 to 11/16 in package of 2
 Wire gauge sizes: All sizes in package of 10
 Letter sizes: A to N in package of 10; O to Z in package of 5

⚠ WARNING: Cancer - www.P65Warnings.ca.gov

Straight Shank Jobber Length Cobalt



L6520 General Purpose, Metric

Bright Finish 0.5 to 1.9 mm
Black Oxide 2.0 to 13.0 mm

(Unit) : mm

EDP	Size	Decimal Equivalent	Flute Length	Overall Length	EDP	Size	Decimal Equivalent	Flute Length	Overall Length	EDP	Size	Decimal Equivalent	Flute Length	Overall Length
0084008	0.5000	0.0197	5	30	0047058	4.7000	0.1850	41	89	0047471	8.9000	0.3504	63	124
0084037	0.6000	0.0236	5.5	30	0047064	4.8000	0.1890			0047488	9.0000	0.3543		
0084066	0.7000	0.0276	7.5	32	0047070	4.9000	0.1929	43	92	0047494	9.1000	0.3583	65	127
0084123	0.8000	0.0315	8	34	0047087	5.0000	0.1969			0047500	9.2000	0.3622		
0084249	0.9000	0.0354	9	36	0047093	5.1000	0.2008	45	95	0047516	9.3000	0.3661	67	130
0046687	1.0000	0.0394	10	40	0047109	5.2000	0.2047			0047522	9.4000	0.3701		
0046693	1.1000	0.0433	11	42	0047115	5.3000	0.2087	47	98	0047539	9.5000	0.3740	69	133
0046709	1.2000	0.0472			13	45	0047121			5.4000	0.2126	0047545		
0046715	1.3000	0.0512	14.5	48	0047138	5.5000	0.2165	49	102	0047551	9.7000	0.3819	70	137
0046721	1.4000	0.0551			16	50	0047144			5.6000	0.2205	0047568		
0046738	1.5000	0.0591	17.5	52	0047150	5.7000	0.2244	51	105	0047574	9.9000	0.3898	72	140
0046744	1.6000	0.0630			20	55	0047167			5.8000	0.2283	0047580		
0046750	1.7000	0.0669	23	58	0047173	5.9000	0.2323	53	108	0047597	10.1000	0.3976	75	143
0046767	1.8000	0.0709			24.5	61	0047180			6.0000	0.2362	0047602		
0046773	1.9000	0.0748	26	64	0047196	6.1000	0.2402	55	111	0047619	10.3000	0.4055	77	146
0046780	2.0000	0.0787			27	67	0047201			6.2000	0.2441	0047625		
0046796	2.1000	0.0827	29.5	71	0047218	6.3000	0.2480	57	114	0047631	10.5000	0.4134	78	149
0046801	2.2000	0.0866			31.5	73	0047224			6.4000	0.2520	0047648		
0046818	2.3000	0.0906	33.5	76	0047230	6.5000	0.2559	59	117	0047654	10.7000	0.4213	80	152
0046824	2.4000	0.0945			36	79	0047247			6.6000	0.2598	0047660		
0046830	2.5000	0.0984	38	83	0047253	6.7000	0.2638	61	121	0047666	10.8000	0.4252	80	152
0046847	2.6000	0.1024			39	86	0047260			6.8000	0.2677	0047677		
0046853	2.7000	0.1063	39	86	0047276	6.9000	0.2717	63	124	0047683	11.0000	0.4331	80	152
0046860	2.8000	0.1102			41	89	0047282			7.0000	0.2756	0047690		
0046876	2.9000	0.1142	41	89	0047299	7.1000	0.2795	61	121	0047705	11.2000	0.4409	80	152
0046882	3.0000	0.1181			43	92	0047304			7.2000	0.2835	0047711		
0046899	3.1000	0.1220	43	92	0047310	7.3000	0.2874	63	124	0047728	11.4000	0.4488	80	152
0046904	3.2000	0.1260			45	95	0047327			7.4000	0.2913	0047734		
0046910	3.3000	0.1299	45	95	0047333	7.5000	0.2953	65	127	0047740	11.6000	0.4567	80	152
0046927	3.4000	0.1339			47	98	0047340			7.6000	0.2992	0047757		
0046933	3.5000	0.1378	47	98	0047356	7.7000	0.3031	67	130	0047763	11.8000	0.4646	80	152
0046940	3.6000	0.1417			49	102	0047362			7.8000	0.3071	0047770		
0046956	3.7000	0.1457	49	102	0047379	7.9000	0.3110	69	133	0047786	12.0000	0.4724	80	152
0046962	3.8000	0.1496			51	105	0047385			8.0000	0.3150	0047792		
0046979	3.9000	0.1535	51	105	0047391	8.1000	0.3189	71	137	0047808	12.2000	0.4803	80	152
0046985	4.0000	0.1575			53	108	0047407			8.2000	0.3228	0047814		
0046991	4.1000	0.1614	53	108	0047413	8.3000	0.3268	73	141	0047820	12.4000	0.4882	80	152
0047006	4.2000	0.1654			55	111	0047420			8.4000	0.3307	0047837		
0047012	4.3000	0.1693	55	111	0047436	8.5000	0.3346	75	145	0047843	12.6000	0.4961	80	152
0047029	4.4000	0.1732			57	114	0047442			8.6000	0.3386	0047850		
0047035	4.5000	0.1772	57	114	0047459	8.7000	0.3425	77	149	0047866	12.8000	0.5039	80	152
0047041	4.6000	0.1811			59	117	0047465			8.8000	0.3465	0047872		
										0047889	13.0000	0.5118		

0.5 to 8.0 in package of 10; 8.1 to 13.0 in package of 5
*JAPAN STOCK ITEM : Please allow 2-3 weeks delivery

⚠ WARNING: Cancer - www.P65Warnings.ca.gov

HSS DRILLS

Straight Shank G Standard



L520P General Purpose, Tin Coated

Range 0.5 to 13.0 mm

(Unit) : mm

EDP	Size	Decimal Equivalent	Flute Length	Overall Length	EDP	Size	Decimal Equivalent	Flute Length	Overall Length	EDP	Size	Decimal Equivalent	Flute Length	Overall Length
0579926	0.5000	0.0197	6	22	0162260	4.7000	0.1850	47	80	0168010	8.9000	0.3504		
0579932	0.6000	0.0236	7	24	0162304	4.8000	0.1890			0168136	9.0000	0.3543		
0579949	0.7000	0.0276	9	28	0162465	4.9000	0.1929			0168348	9.1000	0.3583		
0579955	0.8000	0.0315	10	30	0162516	5.0000	0.1969	52	86	0168405	9.2000	0.3622	81	125
0579961	0.9000	0.0354	11	32	0162539	5.1000	0.2008			0168537	9.3000	0.3661		
0156560	1.0000	0.0394	12	34	0162786	5.2000	0.2047			0168630	9.4000	0.3701		
0156577	1.1000	0.0433	14	36	0162952	5.3000	0.2087			0168938	9.5000	0.3740		
0156611	1.2000	0.0472			0163048	5.4000	0.2126			0171140	9.6000	0.3780		
0156932	1.3000	0.0512	16	38	0163054	5.5000	0.2165			0172176	9.7000	0.3819		
0157086	1.4000	0.0551			0163490	5.6000	0.2205			0172307	9.8000	0.3858		
0157269	1.5000	0.0591	18	40	0163680	5.7000	0.2244	57	93	0172313	9.9000	0.3898		
0157647	1.6000	0.0630			0163730	5.8000	0.2283			0172359	10.0000	0.3937		
0157653	1.7000	0.0669	20	43	0164124	5.9000	0.2323			0172670	10.1000	0.3976	87	133
0157660	1.8000	0.0709			0164153	6.0000	0.2362			0172766	10.2000	0.4016		
0157894	1.9000	0.0748			0164359	6.1000	0.2402			0172823	10.3000	0.4055		
0157968	2.0000	0.0787	24	49	0164394	6.2000	0.2441			0172898	10.4000	0.4094		
0158024	2.1000	0.0827			0164480	6.3000	0.2480			0172910	10.5000	0.4134		
0158030	2.2000	0.0866	27	53	0164548	6.4000	0.2520	63	101	0173005	10.6000	0.4173		
0158133	2.3000	0.0906			0164554	6.5000	0.2559			0173040	10.7000	0.4213		
0158140	2.4000	0.0945			0164852	6.6000	0.2598			0173057	10.8000	0.4252		
0158179	2.5000	0.0984	30	57	0165303	6.7000	0.2638			0174592	10.9000	0.4291		
0158419	2.6000	0.1024			0165378	6.8000	0.2677			0176194	11.0000	0.4331		
0158832	2.7000	0.1063			0165390	6.9000	0.2717			0177607	11.1000	0.4370		
0158970	2.8000	0.1102	33	61	0165429	7.0000	0.2756			0178632	11.2000	0.4409	94	142
0158987	2.9000	0.1142			0165441	7.1000	0.2795			0180009	11.3000	0.4449		
0159181	3.0000	0.1181			0165470	7.2000	0.2835	69	109	0180021	11.4000	0.4488		
0159261	3.1000	0.1220			0165515	7.3000	0.2874			0180160	11.5000	0.4528		
0159312	3.2000	0.1260	36	65	0165630	7.4000	0.2913			0180388	11.6000	0.4567		
0159358	3.3000	0.1299			0165865	7.5000	0.2953			0180400	11.7000	0.4606		
0160520	3.4000	0.1339			0165980	7.6000	0.2992			0181493	11.8000	0.4646		
0161446	3.5000	0.1378	39	70	0166047	7.7000	0.3031			0181836	11.9000	0.4685		
0161481	3.6000	0.1417			0166053	7.8000	0.3071			0182300	12.0000	0.4724		
0161503	3.7000	0.1457			0166425	7.9000	0.3110			0182592	12.1000	0.4764		
0161510	3.8000	0.1496			0166563	8.0000	0.3150	75	117	0183050	12.2000	0.4803		
0161526	3.9000	0.1535			0166700	8.1000	0.3189			0183146	12.3000	0.4843		
0161549	4.0000	0.1575	43	75	0166878	8.2000	0.3228			0183249	12.4000	0.4882		
0161561	4.1000	0.1614			0166964	8.3000	0.3268			0184165	12.5000	0.4921		
0161693	4.2000	0.1654			0167089	8.4000	0.3307			0184537	12.6000	0.4961		
0161750	4.3000	0.1693			0167152	8.5000	0.3346			0184566	12.7000	0.5000		
0161773	4.4000	0.1732			0167226	8.6000	0.3386			0184572	12.8000	0.5039		
0161780	4.5000	0.1772	47	80	0167335	8.7000	0.3425	81	125	0184589	12.9000	0.5079		
0161818	4.6000	0.1811			0167341	8.8000	0.3465			0184595	13.0000	0.5118		

0.5 to 1.9 - 10 per package; 2.0 to 13.0 - 1 per package
 *JAPAN STOCK ITEM : Please allow 2-3 weeks delivery

Straight Shank Jobber Length Tin Coated



L501P General Purpose

Fractional: Range 1/16" to 1/2"
Wire: Range #1 to #52

EDP	Size		Decimal Equivalent	Flute Length	Overall Length
	Fractional	Wire			
1047548	1/16		0.0625	7/8	1 7/8
1001039		#52	0.0635		
1001068		#51	0.0670	1	2
1001102		#50	0.0700		
1001125		#49	0.0730		
1001131		#48	0.0760		
1143985	5/64		0.0781		
1001154		#47	0.0785	1 1/8	2 1/8
1001160		#46	0.0810		
1001177		#45	0.0820		
1001190		#44	0.0860	1 1/4	2 1/4
1001205		#43	0.0890		
1001211		#42	0.0935		
1226503	3/32		0.0938	1 3/8	2 3/8
1001234		#41	0.0960		
1001240		#40	0.0980	1 7/16	2 1/2
1001270		#39	0.0995		
1001308		#38	0.1015		
1001337		#37	0.1040	1 1/2	2 5/8
1001395		#36	0.1065		
1141626	7/64		0.1094		
1001475		#35	0.1100	1 5/8	2 3/4
1001481		#34	0.1110		
1001498		#33	0.1130		
1001503		#32	0.1160	1 3/4	2 7/8
1001510		#31	0.1200		
1144006	1/8		0.1250	1 7/8	3
1001532		#30	0.1285		
1001549		#29	0.1360	2	3 1/8
1001584		#28	0.1405		
1143991	9/64		0.1406	2 1/8	3 1/4
1001606		#27	0.1440		
1001612		#26	0.1470		
1001635		#25	0.1495		
1001693		#24	0.1520		
1001744		#23	0.1540		
1141598	5/32		0.1563		
1001933		#22	0.1570		
1001956		#21	0.1590		
1002012		#20	0.1610		

EDP	Size		Decimal Equivalent	Flute Length	Overall Length
	Fractional	Wire			
1002167		#19	0.1660	2 1/8	3 1/4
1002173		#18	0.1695		
1226510	11/64		0.1719	2 3/16	3 3/8
1002260		#17	0.1730		
1002247		#16	0.1700		
1002310		#15	0.1800	2 5/16	3 1/2
1002385		#14	0.1820		
1002420		#13	0.1850	2 7/16	3 5/8
1226526	3/16		0.1875		
1002734		#12	0.1890		
1002770		#11	0.1910	2 1/2	3 3/4
1002814		#10	0.1935		
1002837		#9	0.1960		
1002889		#8	0.1990	2 5/8	3 7/8
1002952		#7	0.2010		
1174858	13/64		0.2031	2 3/4	4
1002998		#6	0.2040		
1003186		#5	0.2055		
1003192		#4	0.2090	2 7/8	4 1/8
1003208		#3	0.2130		
1226532	7/32		0.2188	2 15/16	4 1/4
1003237		#2	0.2210		
1003300		#1	0.2280	3 1/16	4 3/8
1141632	15/64		0.2344		
1226549	1/4		0.2500	3 3/16	4 1/2
1141603	17/64		0.2656		
1144029	9/32		0.2813	3 5/16	4 5/8
1141610	19/64		0.2969		
1141649	5/16		0.3125	3 7/16	4 3/4
1086513	21/64		0.3281		
1086520	11/32		0.3438	3 1/2	4 7/8
1086536	23/64		0.3594		
1086542	3/8		0.3750	3 3/4	5 1/8
1086559	25/64		0.3906		
1086565	13/32		0.4063	3 15/16	5 3/8
1086571	27/64		0.4219		
1086588	7/16		0.4375	4 3/16	5 5/8
1086594	29/64		0.4531		
1086600	15/32		0.4688	4 3/8	5 7/8
1086616	31/64		0.4844		
1086622	1/2		0.5000	4 1/2	6

Fractional sizes: Sizes 1/64 to 5/16 in package of 10; 21/64 to 1/2 in package of 5; 33/64 to 11/16 in package of 2
Wire gauge sizes: All sizes in package of 10

HSS DRILLS

Straight Shank Jobber Length Parabolic



L517P Tin Coated

Fractional: Range 1/16" to 1/2"
Wire: Range #1 to #52

HSS DRILLS

EDP	Size		Decimal Equivalent	Flute Length	Overall Length
	Fractional	Wire			
1019026	1/16		0.0625	7/8	1 7/8
1019055		#52	0.0635	1	2
1019158		#51	0.0670		
1019318		#50	0.0700		
1019330		#49	0.0730		
1019382		#48	0.0760		
1019399	5/64		0.0781		
1019427		#47	0.0785		
1019440		#46	0.0810	1 1/8	2 1/8
1019462		#45	0.0820		
1019559		#44	0.0860	1 1/4	2 1/4
1019645		#43	0.0890		
1019748		#42	0.0935	1 3/8	2 3/8
1019783	3/32		0.0938		
1019840		#41	0.0960	1 7/16	2 1/2
1019870		#40	0.0980		
1020015		#39	0.0995	1 1/2	2 5/8
1020118		#38	0.1015		
1020153		#37	0.1040	1 5/8	2 3/4
1020233		#36	0.1065		
1020279	7/64		0.1094	1 3/4	2 7/8
1020394		#35	0.1100		
1020451		#34	0.1110	1 7/8	3
1020474		#33	0.1130		
1020497		#32	0.1160	2	3 1/8
1020519		#31	0.1200		
1020531	1/8		0.1250	2 1/8	3 1/4
1020554		#30	0.1285		
1020577		#29	0.1360	2	3 1/8
1020590		#28	0.1405		
1020605	9/64		0.1406	2	3 1/8
1020628		#27	0.1440		
1020640		#26	0.1470	2	3 1/8
1020686		#25	0.1495		
1020714		#24	0.1520	2 1/8	3 1/4
1020737		#23	0.1540		
1020750	5/32		0.1563	2 1/8	3 1/4
1020817		#22	0.1570		
1020852		#21	0.1590	2 1/8	3 1/4
1020881		#20	0.1610		

EDP	Size		Decimal Equivalent	Flute Length	Overall Length
	Fractional	Wire			
1020932		#19	0.1660	2 1/8	3 1/4
1020990		#18	0.1695		
1021028	11/64		0.1719	2 3/16	3 3/8
1021057		#17	0.1730		
1021166		#16	0.1700	2 5/16	3 1/2
1021217		#15	0.1800		
1021246		#14	0.1820	2 7/16	3 5/8
1021275		#13	0.1850		
1021281	3/16		0.1875	2 1/2	3 3/4
1021310		#12	0.1890		
1021384		#11	0.1910	2 5/8	3 7/8
1021515		#10	0.1935		
1021544		#9	0.1960	2 3/4	4
1021596		#8	0.1990		
1021630		#7	0.2010	2 7/8	4 1/8
1021647	13/64		0.2031		
1021660		#6	0.2040	2 15/16	4 1/4
1021682		#5	0.2055		
1021704		#4	0.2090	3 1/16	4 3/8
1021727		#3	0.2130		
1021733	7/32		0.2188	3 3/16	4 1/2
1021779		#2	0.2210		
1021820		#1	0.2280	3 5/16	4 5/8
1021836	15/64		0.2344		
1021842	1/4		0.2500	3 7/16	4 3/4
1021871	17/64		0.2656		
1021888	9/32		0.2813	3 1/2	4 7/8
1021894	19/64		0.2969		
1021900	5/16		0.3125	3 5/8	5
1021922	21/64		0.3281		
1021939	11/32		0.3438	3 3/4	5 1/8
1021951	23/64		0.3594		
1021968	3/8		0.3750	3 7/8	5 1/4
1021974	25/64		0.3906		
1021997	13/32		0.4063	3 15/16	5 3/8
1022001	27/64		0.4219		
1022018	7/16		0.4375	4 1/16	5 1/2
1022024	29/64		0.4531		
1022030	15/32		0.4688	4 3/16	5 5/8
1022047	31/64		0.4844		
1022053	1/2		0.5000	4 5/16	5 3/4
				4 1/2	6

Fractional sizes: Sizes 1/64 to 5/16 in package of 10;
21/64 to 1/2 in package of 5; 33/64 to 11/16 in package of 2
Wire gauge sizes: All sizes in package of 10

Straight Shank Taper Length



L531 General Purpose, Black Oxide

Range 1/64" to 1/2"

EDP	Size	Decimal Equivalent	Flute Length	Overall Length
1278436	1/64	0.0156	5/16	1 1/2
1266264	1/32	0.0313	3/4	2
1266270	3/64	0.0469	1 1/8	2 1/4
1266287	1/16	0.0625	1 3/4	3
1266293	5/64	0.0781	2	3 3/4
1266309	3/32	0.0938	2 1/4	4 1/4
1266315	7/64	0.1094	2 1/2	4 5/8
1266321	1/8	0.1250	2 3/4	5 1/8
1266338	9/64	0.1406	3	5 3/8
1266344	5/32	0.1563	3 3/8	5 3/4
1266350	11/64	0.1719	3 5/8	6
1266367	3/16	0.1875	3 5/8	6
1266373	13/64	0.2031	3 5/8	6
1266380	7/32	0.2188	3 5/8	6
1266396	15/64	0.2344	3 3/4	6 1/8
1266401	1/4	0.2500	3 3/4	6 1/8
1266418	17/64	0.2656	3 7/8	6 1/4
1266424	9/32	0.2813	3 7/8	6 1/4
1266430	19/64	0.2969	4	6 3/8
1266447	5/16	0.3125	4	6 3/8
1266453	21/64	0.3281	4 1/8	6 1/2
1266460	11/32	0.3438	4 1/8	6 1/2
1266476	23/64	0.3594	4 1/4	6 3/4
1266482	3/8	0.3750	4 1/4	6 3/4
1266499	25/64	0.3906	4 3/8	7
1266504	13/32	0.4063	4 3/8	7
1266510	27/64	0.4219	4 5/8	7 1/4
1266527	7/16	0.4375	4 5/8	7 1/4
1266533	29/64	0.4531	4 3/4	7 1/2
1266540	15/32	0.4688	4 3/4	7 1/2
1266556	31/64	0.4844	4 3/4	7 3/4
1266562	1/2	0.5000	4 3/4	7 3/4

Sizes 1/64 to 5/16 in package of 10;
21/64 to 1/2 in package of 5

HSS DRILLS

Straight Shank Taper Length Cobalt



L6531 General Purpose

Range 1/16" to 3/4"

EDP	Size	Decimal Equivalent	Flute Length	Overall Length
1053917	1/16	0.0625	1 3/4	3
1053930	5/64	0.0781	2	3 3/4
1053952	3/32	0.0938	2 1/4	4 1/4
1053975	7/64	0.1094	2 1/2	4 5/8
1053981	1/8	0.1250	2 3/4	5 1/8
1053998	9/64	0.1406	3	5 3/8
1054002	5/32	0.1563		
1054019	11/64	0.1719	3 3/8	5 3/4
1054025	3/16	0.1875		
1054031	13/64	0.2031	3 5/8	6
1054048	7/32	0.2188		
1054060	15/64	0.2344	3 3/4	6 1/8
1054105	1/4	0.2500		
1054140	17/64	0.2656	3 7/8	6 1/4
1054192	9/32	0.2813		
1054220	19/64	0.2969	4	6 3/8
1054243	5/16	0.3125		
1054272	21/64	0.3281	4 1/8	6 1/2
1054300	11/32	0.3438		
1054330	23/64	0.3594	4 1/4	6 3/4
1054352	3/8	0.3750		
1054381	25/64	0.3906	4 3/8	7
1054410	13/32	0.4063		
1054432	27/64	0.4219	4 5/8	7 1/4
1054449	7/16	0.4375		
1054455	29/64	0.4531	4 3/4	7 1/2
1054461	15/32	0.4688		7 3/4
1054478	31/64	0.4844		
1054484	1/2	0.5000		
1058198	33/64	0.5156	8	
1058261	17/32	0.5313		
1058312	35/64	0.5469	4 7/8	8 1/4
1058387	9/16	0.5625		8 3/4
1058450	37/64	0.5781		
1058524	19/32	0.5938		
1058582	39/64	0.6094	5 1/8	9
1058656	5/8	0.6250		
1058713	41/64	0.6406	5 3/8	9 1/4
1058765	21/32	0.6563		
1058822	43/64	0.6719	5 5/8	9 1/2
1058874	11/16	0.6875		
1058925	45/64	0.7031	5 7/8	9 3/4
1058954	23/32	0.7188		
1058990	47/64	0.7344		
1059027	3/4	0.7500		

Sizes 1/64 to 5/16 in package of 10; **⚠ WARNING: Cancer - www.P65Warnings.ca.gov**
21/64 to 1/2 in package of 5

Straight Shank Taper Length Tin Coated



L545P Parabolic Style

Range: 1/16" to 1/2"

EDP	Size	Decimal Equivalent	Flute Length	Overall Length
1001016	1/16	0.0625	1 3/4	3
1001148	5/64	0.0781	2	3 3/4
1001228	3/32	0.0938	2 1/4	4 1/4
1001446	7/64	0.1094	2 1/2	4 5/8
1001526	1/8	0.1250	2 3/4	5 1/8
1001590	9/64	0.1406	3	5 3/8
1001899	5/32	0.1563		
1002218	11/64	0.1719	3 3/8	5 3/4
1002436	3/16	0.1875		
1002975	13/64	0.2031	3 5/8	6
1003214	7/32	0.2188		
1003403	15/64	0.2344	3 3/4	6 1/8
1003455	1/4	0.2500		
1003541	17/64	0.2656	3 7/8	6 1/4
1003609	9/32	0.2813		
1003615	19/64	0.2969	4	6 3/8
1003621	5/16	0.3125		
1003667	21/64	0.3281	4 1/8	6 1/2
1003673	11/32	0.3438		
1003885	23/64	0.3594	4 1/4	6 3/4
1003920	3/8	0.3750		
1003936	25/64	0.3906	4 3/8	7
1004038	13/32	0.4063		
1004130	27/64	0.4219	4 5/8	7 1/4
1004176	7/16	0.4375		
1004199	29/64	0.4531	4 3/4	7 1/2
1004256	15/32	0.4688		
1004285	31/64	0.4844		
1004291	1/2	0.5000		7 3/4

Sizes 1/64 to 5/16 in package of 10;
21/64 to 1/2 in package of 5

HSS DRILLS

Straight Shank Extra Length



L551 General Purpose, Bright

Range 1/8" to 1"
Overall Length 12" and 18"

HSS DRILLS

EDP	Size	Decimal Equivalent	Flute Length	Overall Length
1054490	1/8	0.1250	9	12
1054506	9/64	0.1406		
1054512	5/32	0.1563		
1054529	11/64	0.1719		
1054535	3/16	0.1875		
1054558	13/64	0.2031		
1054570	7/32	0.2188		
1054593	15/64	0.2344		
1054615	1/4	0.2500		
1054638	17/64	0.2656		
1054650	9/32	0.2813		
1054673	19/64	0.2969		
1054696	5/16	0.3125		
1054718	21/64	0.3281		
1054730	11/32	0.3438		
1054753	23/64	0.3594		
1054776	3/8	0.3750		
1054799	25/64	0.3906		
1054810	13/32	0.4063		
1054833	27/64	0.4219		
1054856	7/16	0.4375		
1054879	29/64	0.4531		
1054891	15/32	0.4688		
1054913	31/64	0.4844		
1054936	1/2	0.5000		
1058226	33/64	0.5156		
1058290	17/32	0.5313		
1058341	35/64	0.5469		
1058415	9/16	0.5625		
1058480	37/64	0.5781		
1058553	19/32	0.5938		
1058610	39/64	0.6094		
1058685	5/8	0.6250		
1058800	21/32	0.6563		
1058902	11/16	0.6875		
1058977	23/32	0.7188		
1059040	3/4	0.7500		
1059120	13/16	0.8125		
1059200	7/8	0.8750		

EDP	Size	Decimal Equivalent	Flute Length	Overall Length
1059280	15/16	0.9375	9	12
1059354	1	1.0000		
1054541	3/16	0.1875		
1054564	13/64	0.2031		
1054587	7/32	0.2188		
1054609	15/64	0.2344		
1054621	1/4	0.2500		
1054644	17/64	0.2656		
1054667	9/32	0.2813		
1054680	19/64	0.2969		
1054701	5/16	0.3125		
1054724	21/64	0.3281		
1054747	11/32	0.3438		
1054760	23/64	0.3594		
1054782	3/8	0.3750		
1054804	25/64	0.3906		
1054827	13/32	0.4063		
1054840	27/64	0.4219		
1054862	7/16	0.4375		
1054885	29/64	0.4531		
1054907	15/32	0.4688		
1054920	31/64	0.4844		
1054942	1/2	0.5000		
1058210	33/64	0.5156		
1058284	17/32	0.5313		
1058335	35/64	0.5469		
1058409	9/16	0.5625		
1058473	37/64	0.5781		
1058547	19/32	0.5938		
1058604	39/64	0.6094		
1058679	5/8	0.6250		
1058788	21/32	0.6563		
1058897	11/16	0.6875		
1058960	23/32	0.7188		
1059033	3/4	0.7500		
1059113	13/16	0.8125		
1059194	7/8	0.8750		
1059274	15/16	0.9375		
1059348	1	1.0000		

1 per box

Straight Shank Extra Length Parabolic



L6551 Black Oxide

Range 3/16 to 1/2
Overall Length 10"

EDP	Size	Decimal Equivalent	Flute Length	Overall Length
1010087	3/16	0.1875	7	10
1010109	13/64	0.2031		
1010150	7/32	0.2188		
1010173	15/64	0.2344		
1010196	1/4	0.2500		
1005275	17/64	0.2656		
1005281	9/32	0.2813		
1005298	19/64	0.2969		
1005303	5/16	0.3125		
1005310	21/64	0.3281		
1005326	11/32	0.3438		
1005332	23/64	0.3594		
1005349	3/8	0.3750		
1010333	25/64	0.3906		
1010362	13/32	0.4063		
1010391	27/64	0.4219		
1005390	7/16	0.4375		
1005406	29/64	0.4531		
1010465	15/32	0.4688		
1005435	31/64	0.4844		
1008040	1/2	0.5000		

1 per box

⚠ WARNING: Cancer - www.P65Warnings.ca.gov

HSS DRILLS

Straight Shank Oil Hole



L581 M35 Cobalt, Bright

Range 3/8 to 1 1/2

HSS DRILLS

EDP	Size	Decimal Equivalent	Flute Length	Overall Length
1056974	3/8	0.3750	4 1/4	6 3/4
1056997	25/64	0.3906	4 3/8	7
1057018	13/32	0.4063	4 5/8	7 1/4
1057030	27/64	0.4219	4 7/8	7 1/2
1061093	7/16	0.4375	5	7 3/4
1057060	29/64	0.4531	5 1/4	8
1061109	15/32	0.4688	5 3/8	8 1/4
1057099	31/64	0.4844	5 5/8	8 1/2
1057110	1/2	0.5000	5 7/8	9
1057133	33/64	0.5156	6	9 1/4
1057156	17/32	0.5313	6 1/2	9 7/8
1057179	35/64	0.5469	6 3/4	10
1057191	9/16	0.5625	6 5/8	10
1057213	37/64	0.5781	6 3/8	9 3/4
1057236	19/32	0.5938	6 1/2	9 7/8
1057259	39/64	0.6094	6 3/4	10
1057271	5/8	0.6250	6 5/8	10
1146307	41/64	0.6406	6 3/8	9 3/4
1057316	21/32	0.6563	6 1/2	9 7/8
1057339	43/64	0.6719	6 3/4	10
1057351	11/16	0.6875	6 5/8	10
1057374	45/64	0.7031	6 3/8	9 3/4
1057397	23/32	0.7188	6 1/2	9 7/8
1057419	47/64	0.7344	6 3/4	10
1061115	3/4	0.7500	6 5/8	10
1057448	49/64	0.7656	6 3/8	9 3/4
1057460	25/32	0.7813	6 1/2	9 7/8
1057483	51/64	0.7969	6 3/4	10

1 per box

EDP	Size	Decimal Equivalent	Flute Length	Overall Length
1057505	13/16	0.8125	6 5/8	10
1057528	53/64	0.8281	6 3/4	10 1/4
1057540	27/32	0.8438	7	10 1/2
1057563	55/64	0.8594	7 1/8	10 7/8
1061121	7/8	0.8750	7 3/16	11
1057592	57/64	0.8906	7 5/16	11 1/8
1057614	29/32	0.9063	7 3/8	11 1/4
1057637	59/64	0.9219	7 5/8	11 1/2
1057650	15/16	0.9375	7 7/8	11 3/4
1057672	61/64	0.9531	8	11 7/8
1057695	31/32	0.9688	8 1/8	12
1057717	63/64	0.9844	8 1/2	12 1/2
1057730	1	1.0000	8 3/4	12 1/2
1057752	1 1/64	1.0156	8 1/2	12 1/2
1057769	1 1/32	1.0313	8 3/4	12 1/2
1057775	1 3/64	1.0469	8 1/2	12 1/2
1057781	1 1/16	1.0625	8 3/4	12 1/2
1057803	1 3/32	1.0938	8 1/2	12 1/2
1057810	1 1/8	1.1250	8 3/4	12 1/2
1057832	1 5/32	1.1563	8 1/2	12 1/2
1057849	1 3/16	1.1875	8 3/4	12 1/2
1057861	1 7/32	1.2188	8 1/2	12 1/2
1057878	1 1/4	1.2500	8 3/4	12 1/2
1057890	1 5/16	1.3125	8 1/2	12 1/2
1057912	1 3/8	1.3750	8 3/4	12 1/2
1057935	1 7/16	1.4375	8 1/2	12 1/2
1057958	1 1/2	1.5000	8 3/4	12 1/2

⚠ WARNING: Cancer - www.P65Warnings.ca.gov

Taper Shank Regular Length



L601 General Purpose, Black Oxide

Range 9/32" to 3 1/2"

EDP	Size	Decimal Equivalent	Flute Length	Overall Length	Taper Shank	EDP	Size	Decimal Equivalent	Flute Length	Overall Length	Taper Shank	EDP	Size	Decimal Equivalent	Flute Length	Overall Length	Taper Shank
1267305	9/32	0.2813	3	6 1/4	1	1269097	31/32	0.9688			3	1270269	1 21/32	1.6563	10 1/8	17 1/8	
1267328	19/64	0.2969	3 1/8	6 3/8		1269125	63/64	0.9844	6 3/8	11		1270275	1 43/64	1.6719			
1267357	5/16	0.3125				1269160	1	1.0000				1270281	1 11/16	1.6875			
1267363	21/64	0.3281	3 1/4	6 1/2		1269205	1 1/64	1.0156	6 1/2	11 1/8		1270298	1 45/64	1.7031			
1267370	11/32	0.3438				1269234	1 1/32	1.0313				1270303	1 23/32	1.7188			
1267386	23/64	0.3594	3 1/2	6 3/4		1269240	1 3/64	1.0469	6 5/8	11 1/4		1270332	1 47/64	1.7344			
1267392	3/8	0.3750				1269263	1 1/16	1.0625				1270361	1 3/4	1.7500			
1267408	25/64	0.3906	3 5/8	7		1269286	1 5/64	1.0781	6 7/8	12 1/2		1270390	1 25/32	1.7813			
1267414	13/32	0.4063				1269314	1 3/32	1.0938				1270429	1 13/16	1.8125			
1268221	27/64	0.4219	3 7/8	7 1/4		1269337	1 7/64	1.1094	7 1/8	12 3/4		1270458	1 27/32	1.8438			
1268238	7/16	0.4375				1269366	1 1/8	1.1250				1270487	1 7/8	1.8750			
1268250	29/64	0.4531	4 1/8	7 1/2		1269400	1 9/64	1.1406	7 1/4	12 7/8		1270515	1 29/32	1.9063			
1268296	15/32	0.4688			1269430	1 5/32	1.1563			1270630	1 15/16	1.9375					
1268318	31/64	0.4844	4 3/8	8 1/4	1269469	1 11/64	1.1719	7 3/8	13	1270660	1 31/32	1.9688					
1268330	1/2	0.5000			1269498	1 3/16	1.1875			1270699	2	2.0000					
1268353	33/64	0.5156	4 5/8	8 1/2	1269526	1 13/64	1.2031	7 1/2	13 1/8	1270727	2 1/32	2.0313					
1268376	17/32	0.5313			1269664	1 7/32	1.2188			1270762	2 1/16	2.0625					
1268399	35/64	0.5469			1269709	1 15/64	1.2344	7 7/8	13 1/2	1270785	2 3/32	2.0938					
1268410	9/16	0.5625			1269773	1 1/4	1.2500			1270807	2 1/8	2.1250					
1268433	37/64	0.5781	4 7/8	8 3/4	1269830	1 17/64	1.2656	8 1/2	14 1/8	1270836	2 5/32	2.1563					
1268456	19/32	0.5938			1269899	1 9/32	1.2813			1270859	2 3/16	2.1875					
1268479	39/64	0.6094			1269910	1 19/64	1.2969	8 5/8	14 1/4	1270865	2 7/32	2.2188					
1268507	5/8	0.6250			1269927	1 5/16	1.3125			1270871	2 1/4	2.2500					
1268513	41/64	0.6406			1269933	1 21/64	1.3281	8 3/4	14 3/8	1270888	2 5/16	2.3125					
1268536	21/32	0.6563	5 1/8	9	1269940	1 11/32	1.3438			1270894	2 3/8	2.3750					
1268565	43/64	0.6719	5 3/8	9 1/4	1269956	1 23/64	1.3594	8 7/8	14 1/2	1270900	2 7/16	2.4375					
1268588	11/16	0.6875			1269962	1 3/8	1.3750			1270916	2 1/2	2.5000					
1268600	45/64	0.7031	5 5/8	9 1/2	1269979	1 25/64	1.3906	9	14 5/8	1270922	2 9/16	2.5625					
1268639	23/32	0.7188			1269985	1 13/32	1.4063			1270939	2 5/8	2.6250					
1268668	47/64	0.7344	5 7/8	9 3/4	1269991	1 27/64	1.4219	9 1/8	14 3/4	1270945	2 11/16	2.6875					
1268680	3/4	0.7500			1270005	1 7/16	1.4375			1270951	2 3/4	2.7500					
1268702	49/64	0.7656	6	9 7/8	1270011	1 29/64	1.4531	9 1/4	14 7/8	1270968	2 13/16	2.8125					
1268725	25/32	0.7813			1270028	1 15/32	1.4688			1270974	2 7/8	2.8750					
1268886	51/64	0.7969			1270034	1 31/64	1.4844			1270980	2 15/16	2.9375					
1268892	13/16	0.8125			1270040	1 1/2	1.5000	9 3/8	15	1270997	3	3.0000					
1268908	53/64	0.8281			1270057	1 33/64	1.5156			1271001	3 1/16	3.0625					
1268914	27/32	0.8438			1270063	1 17/32	1.5313			1271018	3 1/8	3.1250					
1268920	55/64	0.8594	6 1/8	10 3/4	1270070	1 35/64	1.5469	9 5/8	16 3/8	1271024	3 3/16	3.1875					
1268943	7/8	0.8750			1270086	1 9/16	1.5625			1271030	3 1/4	3.2500					
1268972	57/64	0.8906			1270092	1 37/64	1.5781	9 7/8	16 5/8	1271047	3 5/16	3.3125					
1268995	29/32	0.9063			1270108	1 19/32	1.5938			1271076	3 3/8	3.3750					
1269022	59/64	0.9219			1270114	1 39/64	1.6094	10	17	1271127	3 7/16	3.4375					
1269051	15/16	0.9375			1270120	1 5/8	1.6250			1271179	3 1/2	3.5000					
1269080	61/64	0.9531	6 3/8	11	1270246	1 41/64	1.6406	10 1/8	17 1/8								

1 per box

HSS DRILLS

Taper Shank Extra Length



L651 Bright

Range 1/4 to 2 1/2
Overall Length 18"

HSS DRILLS

EDP	Size	Decimal Equivalent	Flute Length	Overall Length	Overall Length	Taper Shank		
1057970	1/4	0.2500	14	18		1		
1057987	17/64	0.2656	14					
1057993	9/32	0.2813	14					
1058008	19/64	0.2969	14					
1058014	5/16	0.3125	14					
1058020	5/16	0.3125	20				24	
1058037	21/64	0.3281	14				18	
1058043	11/32	0.3438	14					
1058050	23/64	0.3594	14					
1058066	3/8	0.3750	14					
1058072	3/8	0.3750	20	24				
1058089	25/64	0.3906	14	18				
1058095	13/32	0.4063	14					
1058100	27/64	0.4219	14					
1058117	7/16	0.4375	14					
1058123	7/16	0.4375	20	24				
1058130	29/64	0.4531	14	18				
1058146	15/32	0.4688	14					
1058152	31/64	0.4844	14					
1058169	1/2	0.5000	14					
1058175	1/2	0.5000	20	24				
1058181	33/64	0.5156	14	18	2			
1061138	33/64	0.5156	20	24				
1058249	17/32	0.5313	14	18				
1058255	17/32	0.5313	20	24				
1061144	35/64	0.5469	14	18				
1058364	9/16	0.5625	14					
1058370	9/16	0.5625	20				24	
1058438	37/64	0.5781	14				18	
1058444	37/64	0.5781	20	24				
1058501	19/32	0.5938	14	18		3		
1058518	19/32	0.5938	20	24				
1058576	39/64	0.6094	14	18				
1058633	5/8	0.6250	14	20				
1058640	5/8	0.6250	20					
1058707	41/64	0.6406	14				18	
1058742	21/32	0.6563	14				24	
1058759	21/32	0.6563	20					
1058816	43/64	0.6719	14	18				
1058851	11/16	0.6875	14	24				
1058868	11/16	0.6875	20					
1058919	45/64	0.7031	14			18		
1058931	23/32	0.7188	14			24		
1058948	23/32	0.7188	20					
1058983	47/64	0.7344	14	18				
1059004	3/4	0.7500	14	24				
1059010	3/4	0.7500	20					
1059056	49/64	0.7656	14			18		
1059062	25/32	0.7813	14			24		
1059079	25/32	0.7813	20					
1059085	51/64	0.7969	13	18				
1059091	13/16	0.8125	13	24				
1059107	13/16	0.8125	19					
1059136	53/64	0.8281	13			18		
1059142	27/32	0.8438	13			24		
1059159	27/32	0.8438	19					
1059165	55/64	0.8594	13	18				

EDP	Size	Decimal Equivalent	Flute Length	Overall Length	Overall Length	Taper Shank		
1059171	7/8	0.8750	13	18	24	3		
1059188	7/8	0.8750	19					
1059216	57/64	0.8906	13	18				
1059222	29/32	0.9063	13	24				
1059239	29/32	0.9063	19					
1059245	59/64	0.9219	13					18
1059251	15/16	0.9375	13					24
1059268	15/16	0.9375	19					
1059297	61/64	0.9531	13	18				
1059302	31/32	0.9688	13	24				
1059319	31/32	0.9688	19					
1059325	63/64	0.9844	13		18			
1061167	1	1.0000	13		24			
1059331	1	1.0000	19					
1059360	1 1/32	1.0313	13	18				
1059377	1 1/16	1.0625	13	24				
1059383	1 1/16	1.0625	19					
1059390	1 3/32	1.0938	12		18			
1059405	1 1/8	1.1250	12		24			
1059411	1 1/8	1.1250	19					
1059428	1 5/32	1.1563	12	18				
1229743	1 5/32	1.1563	18	24				
1059434	1 3/16	1.1875	12	18	4			
1059440	1 3/16	1.1875	18	24				
1059457	1 7/32	1.2188	12	18				
1229750	1 7/32	1.2188	18	24				
1059463	1 1/4	1.2500	12	18				
1059470	1 1/4	1.2500	18	24				
1059486	1 9/32	1.2813	12	18		5		
1059492	1 5/16	1.3125	12	24				
1059508	1 5/16	1.3125	18	24				
1059514	1 11/32	1.3438	12					18
1059520	1 3/8	1.3750	12		24			
1059537	1 3/8	1.3750	18					
1059543	1 13/32	1.4063	12	18				
1059550	1 7/16	1.4375	12	24				
1059566	1 7/16	1.4375	18					
1059572	1 15/32	1.4688	12		18			
1059589	1 1/2	1.5000	12		24			
1059595	1 1/2	1.5000	18					
1059600	1 9/16	1.5625	10 1/2	18				
1059617	1 9/16	1.5625	17	24				
1059623	1 5/8	1.6250	10 1/2	18	24			
1059630	1 5/8	1.6250	17					
1059646	1 11/16	1.6875	10 1/2	18				
1059652	1 11/16	1.6875	17	24				
1059669	1 3/4	1.7500	10 1/2	18				
1059675	1 3/4	1.7500	17	24				
1059681	1 7/8	1.8750	10 1/2	18		24		
1059698	1 7/8	1.8750	17					
1059703	2	2.0000	10 1/2	18				
1061173	2	2.0000	17	24				
1059726	2 1/16	2.0625	17					
1059749	2 1/8	2.1250	17					
1059761	2 1/4	2.2500	17					
1159848	2 3/8	2.3750	17	24				
1059784	2 1/2	2.5000	17					

Taper Shank Oil Hole



L683 M35 Cobalt, Bright

Range 3/8 to 1 1/2

EDP	Size	Decimal Equivalent	Flute Length	Overall Length	Taper Shank	
1056980	3/8	0.3750	4 1/4	8 1/8	2	
1057001	25/64	0.3906	4 3/8	8 1/4		
1057024	13/32	0.4063	4 5/8	8 1/2		
1057047	27/64	0.4219				
1057053	7/16	0.4375	4 7/8	8 3/4		
1057076	29/64	0.4531				
1057082	15/32	0.4688	5	9 5/8		
1057104	31/64	0.4844				
1057127	1/2	0.5000				
1057140	33/64	0.5156			5 1/8	9 3/4
1057162	17/32	0.5313				
1057185	35/64	0.5469			5 1/4	9 7/8
1057207	9/16	0.5625				
1057220	37/64	0.5781			5 1/2	10 1/8
1057242	19/32	0.5938				
1057265	39/64	0.6094			5 5/8	10 1/4
1057288	5/8	0.6250				
1057300	41/64	0.6406	5 3/4	10 3/8		
1057322	21/32	0.6563				
1057345	43/64	0.6719	5 7/8	10 1/2		
1057368	11/16	0.6875				
1057380	45/64	0.7031	6 1/8	10 3/4		
1057402	23/32	0.7188				
1057425	47/64	0.7344	6 1/4	10 7/8		
1057431	3/4	0.7500				

EDP	Size	Decimal Equivalent	Flute Length	Overall Length	Taper Shank	
1057454	49/64	0.7656	6 3/8	11	3	
1057477	25/32	0.7813				
1057490	51/64	0.7969	6 1/2	11 1/8		
1057511	13/16	0.8125				
1057534	53/64	0.8281	6 5/8	11 1/4		
1057557	27/32	0.8438				
1057570	55/64	0.8594	6 7/8	11 1/2		
1057586	7/8	0.8750				
1057608	57/64	0.8906				
1057620	29/32	0.9063				
1057643	59/64	0.9219				
1057666	15/16	0.9375				
1057689	61/64	0.9531			7	11 5/8
1057700	31/32	0.9688				
1057723	63/64	0.9844			7 1/8	11 3/4
1057746	1	1.0000				
1057798	1 1/16	1.0625	7 1/4	12 7/8	4	
1057826	1 1/8	1.1250	7 3/4	13 3/8		
1057855	1 3/16	1.1875	8	13 5/8		
1057884	1 1/4	1.2500	8 1/4	13 7/8		
1057906	1 5/16	1.3125	9 1/8	14 3/4		
1057929	1 3/8	1.3750	9 3/8	15		
1057941	1 7/16	1.4375	9 1/2	15 1/8		
1057964	1 1/2	1.5000	9 3/4	15 3/8		

1 per box

! WARNING: Cancer - www.P65Warnings.ca.gov

HSS DRILLS

Silver and Deming



L575 High Speed Steel, Bright

Shank Diameter 1/2" by 2 1/2" long
Range 1/2 to 1 1/2

HSS DRILLS

EDP	Size	Decimal Equivalent	Flute Length	Overall Length
1023604	1/2	0.5000	3 1/8	6
1015599	33/64	0.5156		
1016600	17/32	0.5312		
1015604	35/64	0.5469		
1023839	9/16	0.5625		
1015640	37/64	0.5781		
1023925	19/32	0.5938		
1062352	39/64	0.6094		
1024062	5/8	0.6250		
1015656	41/64	0.6406		
1024194	21/32	0.6562		
1015685	43/64	0.6719		
1024319	11/16	0.6875		
1015765	45/64	0.7031		
1024550	23/32	0.7187		
1015771	47/64	0.7344		
1024909	3/4	0.7500		
1015788	49/64	0.7656	3	6
1025178	25/32	0.7812		
1015822	51/64	0.7969		
1025642	13/16	0.8125		
1015839	53/64	0.8281		
1026408	27/32	0.8438		
1015845	55/64	0.8594		
1027250	7/8	0.8750		

EDP	Size	Decimal Equivalent	Flute Length	Overall Length		
1015851	57/64	0.8906	3	6		
1027857	29/32	0.9062				
1015874	59/64	0.9219				
1028148	15/16	0.9375				
1015897	61/64	0.9531				
1028498	31/32	0.9687				
1015902	63/64	0.9844				
1028721	1	1.0000				
1015919	1 1/32	1.0312				
1029391	1 1/16	1.0625				
1015925	1 3/32	1.0938				
1029757	1 1/8	1.1250				
1015948	1 5/32	1.1562				
1030300	1 3/16	1.1875				
1015954	1 7/32	1.2188				
1030993	1 1/4	1.1250				
1005922	1 9/32	1.2812			2 3/4	6
1005939	1 5/16	1.3125				
1011054	1 11/32	1.3438				
1005951	1 3/8	1.3750				
1011140	1 13/32	1.4062				
1005968	1 7/16	1.4375				
1011163	1 15/32	1.4688				
1005974	1 1/2	1.5000				

1 per box

Drill Set Jobber Length

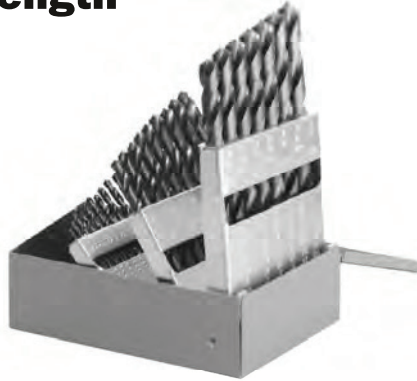

L599 Black Oxide

EDP	HIGH SPEED DRILL SETS	SET NO.
Fractional Sizes	Fractional Sizes	
3599013	1/16" To 1/4" By 64ths	S13
3599015	1/16" To 1/2" By 32nds	S15
3599021	1/16" To 3/8" By 64ths	S21
3599129	1/16" To 1/2" By 64ths	S29
Wire Gauge Sizes	Wire Gauge Sizes	
3599060	No.1 To No. 60	S60
3599020	No.61 To No. 80	S20
Letter Sizes	Letter Sizes	
3599026	A To Z	S26
Combination Sizes	Combination Sizes	
3599115	S29, S60, S26	S115
EDP	COBALT DRILL SETS	SET NO.
Fractional Sizes	Fractional Sizes	
3599029	1/16" To 1/2" By 64ths	C29

WARNING: Cancer - www.P65Warnings.ca.gov

HSS DRILLS

Standard Drilling Conditions

Straight Shank

Screw Machine Length L561, L563
Jobber Length L500, L501, L501A, L599
Taper Length L531

Straight Shank Cobalt

Screw Machine Length L6563
Jobber Length L6501, L6520, L599
Taper Length L6531

Workpiece Material			Carbon Steels		Alloy Steels Hardened Steels		Mold Steels Stainless Steels		Titanium Alloys ¹⁾ High Temperature ¹⁾ Alloys		Cast Irons		Aluminum Alloys Nonferrous Metals	
Speed (SFM)			50 - 65 SFM		40 - 52 SFM		30 - 40 SFM		10 - 20 SFM		55 - 72 SFM		83 - 115 SFM	
Drill Diameter			50 - 65 SFM		40 - 52 SFM		30 - 40 SFM		10 - 20 SFM		55 - 72 SFM		83 - 115 SFM	
Fractional	Metric mm	Decimal	RPM	Feed (IPR)	RPM	Feed (IPR)	RPM	Feed (IPR)	RPM	Feed (IPR)	RPM	Feed (IPR)	RPM	Feed (IPR)
—	1	0.0394	4,800	0.0008	3,800	0.0007	2,900	0.0006	1,500	0.0003	5,300	0.0010	8,100	0.0007
1/16	1.588	0.0625	3,400	0.0013	2,700	0.0011	2,100	0.0009	1,000	0.0005	3,800	0.0015	5,800	0.0011
—	2	0.0787	2,900	0.0016	2,300	0.0013	1,700	0.0012	720	0.0006	3,200	0.0020	4,900	0.0014
—	3	0.1181	2,100	0.0028	1,700	0.0023	1,300	0.0021	480	0.0009	2,300	0.0034	3,600	0.0024
1/8	3.175	0.1250	2,000	0.0029	1,700	0.0023	1,200	0.0022	460	0.0010	2,200	0.0036	3,500	0.0025
—	5	0.1969	1,300	0.0042	1,000	0.0037	760	0.0033	290	0.0015	1,400	0.0053	2,200	0.0038
1/4	6.35	0.2500	1,100	0.0047	800	0.0044	610	0.0038	230	0.0020	1,120	0.0064	1,750	0.0044
—	8	0.3150	800	0.0059	640	0.0050	480	0.0044	180	0.0025	900	0.0074	1,400	0.0051
3/8	9.525	0.3750	680	0.0065	540	0.0055	400	0.0049	160	0.0030	740	0.0082	1,200	0.0054
—	10	0.3937	640	0.0068	510	0.0057	380	0.0050	150	0.0032	700	0.0084	1,100	0.0057
—	12	0.4724	530	0.0074	420	0.0064	320	0.0057	120	0.0040	580	0.0095	900	0.0066
1/2	12.7	0.5000	510	0.0076	400	0.0066	310	0.0057	120	0.0043	550	0.0099	860	0.0069
5/8	15.875	0.6250	410	0.0089	330	0.0076	250	0.0065	100	0.0050	450	0.0115	690	0.0086
—	16	0.6299	400	0.0091	320	0.0078	240	0.0067	90	0.0050	440	0.0116	680	0.0087

1) The cutting condition of Titanium Alloys and Nickel Alloys are for HSS-Co drills only.

2) The above values apply when coolant is used in a vertical machine. In a horizontal machine or deep hole, use pecking.

3) Adjust drilling condition when unusual vibration or different sound occurs.

Standard Drilling Conditions

Straight Shank TiN Coated

Screw Machine Length L561P
Jobber Length L501P, L520P

Workpiece Material			Carbon Steels		Alloy Steels		Die Steels Hardened Steels Stainless Steels		Cast Irons		Aluminum Alloys Nonferrous Metals	
Speed (SFM)			60 - 85 SFM		47 - 65 SFM		36 - 48 SFM		66 - 90 SFM		100 - 140 SFM	
Drill Diameter			60 - 85 SFM		47 - 65 SFM		36 - 48 SFM		66 - 90 SFM		100 - 140 SFM	
Fractional	Metric mm	Decimal	RPM	Feed (IPR)	RPM	Feed (IPR)	RPM	Feed (IPR)	RPM	Feed (IPR)	RPM	Feed (IPR)
—	1	0.0394	5,800	0.0008	4,600	0.0007	3,500	0.0006	6,400	0.0010	9,800	0.0007
1/16	1.588	0.0625	4,100	0.0013	3,200	0.0011	2,500	0.0009	4,400	0.0015	7,000	0.0011
—	2	0.0787	3,500	0.0016	2,800	0.0013	2,000	0.0012	3,800	0.0020	5,900	0.0014
—	3	0.1181	2,500	0.0028	2,000	0.0023	1,500	0.0021	2,800	0.0034	4,300	0.0024
1/8	3.175	0.1250	2,400	0.0029	2,000	0.0023	1,400	0.0022	2,600	0.0036	4,200	0.0025
—	5	0.1969	1,600	0.0042	1,200	0.0037	910	0.0033	1,700	0.0053	2,600	0.0038
1/4	6.35	0.2500	1,300	0.0047	1,000	0.0044	730	0.0038	1,300	0.0064	2,100	0.0044
—	8	0.3150	1,000	0.0059	770	0.0050	580	0.0044	1,100	0.0074	1,700	0.0051
3/8	9.525	0.3750	820	0.0065	650	0.0055	480	0.0049	890	0.0082	1,400	0.0054
—	10	0.3937	770	0.0068	610	0.0057	460	0.0050	840	0.0084	1,300	0.0057
—	12	0.4724	640	0.0074	500	0.0064	380	0.0057	700	0.0095	1,100	0.0066
1/2	12.7	0.5000	610	0.0076	490	0.0066	370	0.0057	670	0.0099	1,000	0.0069
5/8	15.875	0.6250	500	0.0089	400	0.0076	300	0.0065	540	0.0115	830	0.0086
—	16	0.6299	480	0.0091	380	0.0078	290	0.0067	530	0.0116	820	0.0087

1) The above values apply when coolant is used in a vertical machine. In a horizontal machine or deep hole, use pecking.

2) Adjust drilling condition when unusual vibration or different sound occurs.

Straight Shank Parabolic Style TiN Coated

Jobber Length L517P

Taper Length L545P

Workpiece Material			Carbon Steels		Alloy Steels		Die Steels Hardened Steels Stainless Steels		Cast Irons	
Speed (SFM)			60 - 85 SFM		47 - 65 SFM		36 - 48 SFM		66 - 90 SFM	
Drill Diameter			60 - 85 SFM		47 - 65 SFM		36 - 48 SFM		66 - 90 SFM	
Fractional	Metric mm	Decimal	RPM	Feed (IPR)	RPM	Feed (IPR)	RPM	Feed (IPR)	RPM	Feed (IPR)
—	1	0.0394	5,800	0.0011	4,600	0.0009	3,500	0.0008	6,400	0.0014
1/16	1.588	0.0625	4,100	0.0018	3,200	0.0014	2,500	0.0012	4,400	0.0021
—	2	0.0787	3,500	0.0023	2,800	0.0017	2,000	0.0015	3,800	0.0028
—	3	0.1181	2,500	0.0039	2,000	0.0030	1,500	0.0027	2,800	0.0048
1/8	3.175	0.1250	2,400	0.0041	2,000	0.0030	1,400	0.0029	2,600	0.0050
—	5	0.1969	1,600	0.0059	1,200	0.0048	910	0.0042	1,700	0.0075
1/4	6.35	0.2500	1,300	0.0066	1,000	0.0057	730	0.0049	1,300	0.0089
—	8	0.3150	1,000	0.0083	770	0.0066	580	0.0058	1,100	0.0104
3/8	9.525	0.3750	820	0.0091	650	0.0072	480	0.0063	890	0.0115
—	10	0.3937	770	0.0095	610	0.0074	460	0.0065	840	0.0118
—	12	0.4724	640	0.0104	500	0.0083	380	0.0074	700	0.0133
1/2	12.7	0.5000	610	0.0107	490	0.0086	370	0.0075	670	0.0139
5/8	15.875	0.6250	500	0.0124	400	0.0099	300	0.0085	540	0.0161
—	16	0.6299	480	0.0127	380	0.0101	290	0.0087	530	0.0163

1) The above values apply when coolant is used in a vertical machine. In a horizontal machine or deep hole, use pecking.

2) Adjust drilling condition when unusual vibration or different sound occurs.

Standard Drilling Conditions

Straight Shank Parabolic Style TiN Coated

Straight Shank Extra Length L551, L6551

Taper Shank Extra Length L651

Workpiece Material		Carbon Steels		Alloy Steels Hardened Steels		Stainless Steels		Cast Irons		Brass Nonferrous Metals	
Speed (SFM)		44 - 55 SFM		32 - 40 SFM		32 - 40 SFM		52 - 65 SFM		48 - 60 SFM	
Drill Diameter		44 - 55 SFM		32 - 40 SFM		32 - 40 SFM		52 - 65 SFM		48 - 60 SFM	
Fractional	Decimal	RPM	Feed (IPR)	RPM	Feed (IPR)	RPM	Feed (IPR)	RPM	Feed (IPR)	RPM	Feed (IPR)
1/16	0.0625	2,700	0.0020	2,000	0.0010	2,000	0.0015	3,200	0.0015	3,000	0.0020
1/8	0.1250	1,600	0.0038	1,200	0.0018	1,200	0.0025	1,800	0.0025	1,700	0.0036
3/16	0.1875	1,200	0.0052	820	0.0025	820	0.0035	1,400	0.0035	1,300	0.0050
1/4	0.2500	850	0.0065	620	0.0030	620	0.0048	1,000	0.0048	1,000	0.0063
5/16	0.3125	680	0.0075	490	0.0035	490	0.0055	800	0.0055	740	0.0078
3/8	0.3750	570	0.0090	410	0.0040	410	0.0060	670	0.0060	620	0.0090
1/2	0.5000	430	0.0110	310	0.0052	310	0.0080	500	0.0080	460	0.0110
5/8	0.6250	340	0.0120	250	0.0060	250	0.0090	400	0.0090	370	0.0120
3/4	0.7500	290	0.0130	210	0.0070	210	0.0100	340	0.0100	310	0.0130
1	1.0000	220	0.0140	160	0.0080	160	0.0110	250	0.0110	230	0.0140

1) The above values apply when coolant is used in a vertical machine. In a horizontal machine or deep hole, use pecking.

2) Adjust drilling condition when unusual vibration or different sound occurs.

Standard Drilling Conditions Straight Shank Oil Hole Cobalt L581

Workpiece Material		Carbon Steels		Alloy Steels		Die Steels Hardened Steels Stainless Steels		Cast Irons		Aluminum Alloys Nonferrous Alloys	
Speed (SFM)		55 - 66 SFM		44 - 52 SFM		32 - 40 SFM		61 - 73 SFM		94 - 114 SFM	
Drill Diameter		55 - 66 SFM		44 - 52 SFM		32 - 40 SFM		61 - 73 SFM		94 - 114 SFM	
Fractional	Decimal	RPM	Feed (IPR)	RPM	Feed (IPR)	RPM	Feed (IPR)	RPM	Feed (IPR)	RPM	Feed (IPR)
1/16	0.0625	3,400	0.0016	2,700	0.0013	2,100	0.0011	3,800	0.0018	5,800	0.0013
1/8	0.1250	2,000	0.0035	1,700	0.0027	1,200	0.0027	2,200	0.0043	3,500	0.0030
1/4	0.2500	1,100	0.0056	800	0.0052	610	0.0046	1,120	0.0076	1,750	0.0053
3/8	0.3750	680	0.0078	540	0.0066	400	0.0058	740	0.0099	1,200	0.0065
1/2	0.5000	510	0.0091	400	0.0079	310	0.0069	550	0.0119	860	0.0082
5/8	0.6250	410	0.0106	330	0.0091	250	0.0079	450	0.0138	690	0.0103

1) The above values apply when coolant is used in a vertical machine. In a horizontal machine or deep hole, use pecking.

2) Adjust drilling condition when unusual vibration or different sound occurs.

Standard Drilling Conditions Taper Shank Regular Shank / Core L601 Silver and Deming L575

Workpiece Material		Carbon Steels		Alloy Steels		Die Steels Hardened Steels Stainless Steels		Cast Irons		Aluminum Alloys Nonferrous Alloys	
Speed (SFM)		55 - 65 SFM		50 - 60 SFM		35 - 45 SFM		65 - 80 SFM		100 - 110 SFM	
Drill Diameter		55 - 65 SFM		50 - 60 SFM		35 - 45 SFM		65 - 80 SFM		100 - 110 SFM	
Fractional	Decimal	RPM	Feed (IPR)	RPM	Feed (IPR)	RPM	Feed (IPR)	RPM	Feed (IPR)	RPM	Feed (IPR)
1/8	0.1250	2,000	0.003	1,900	0.003	1,400	0.002	2,500	0.004	3,400	0.003
3/16	0.1875	1,400	0.004	1,300	0.004	920	0.003	1,700	0.005	2,300	0.005
1/4	0.2500	1,000	0.004	920	0.005	690	0.004	1,300	0.007	1,700	0.006
5/16	0.3125	800	0.004	740	0.005	560	0.005	980	0.008	1,400	0.008
3/8	0.3750	670	0.007	620	0.006	460	0.005	820	0.008	1,200	0.008
7/16	0.4375	570	0.007	530	0.006	400	0.005	700	0.009	970	0.009
1/2	0.5000	500	0.008	460	0.006	350	0.006	620	0.010	850	0.009
5/8	0.6250	400	0.009	370	0.008	280	0.007	490	0.012	680	0.012
3/4	0.7500	340	0.010	310	0.009	230	0.008	410	0.013	570	0.013
7/8	0.8750	290	0.011	270	0.009	200	0.008	350	0.014	490	0.014
1	1.0000	250	0.012	230	0.010	180	0.009	310	0.015	430	0.014
1 1/8	1.1250	230	0.012	210	0.011	160	0.010	280	0.016	380	0.015
1 1/4	1.2500	200	0.014	190	0.011	140	0.010	250	0.016	340	0.016
1 3/8	1.3750	190	0.014	170	0.012	130	0.010	230	0.017	310	0.017
1 1/2	1.5000	170	0.014	160	0.012	120	0.011	210	0.017	290	0.017
1 5/8	1.6250	160	0.015	150	0.013	110	0.011	190	0.017	260	0.017
1 3/4	1.7500	150	0.016	140	0.013	100	0.011	180	0.018	250	0.018
1 7/8	1.8750	140	0.016	130	0.014	100	0.012	170	0.019	230	0.019
2	2.0000	130	0.016	120	0.014	90	0.012	160	0.020	220	0.020

Taper Shank Oil Hole Drills / Cobalt List No. 683

Workpiece Material		Carbon Steels		Alloy Steels Hardened Steels		Mold Steels Stainless Steels		Cast Irons		Aluminum Alloys Nonferrous Metals	
Speed (SFM)		55 - 65 SFM		50 - 60 SFM		35 - 45 SFM		65 - 80 SFM		100 - 110 SFM	
Drill Diameter		55 - 65 SFM		50 - 60 SFM		35 - 45 SFM		65 - 80 SFM		100 - 110 SFM	
Fractional	Decimal	RPM	Feed (IPR)	RPM	Feed (IPR)	RPM	Feed (IPR)	RPM	Feed (IPR)	RPM	Feed (IPR)
3/8	0.3750	680	0.008	620	0.007	460	0.006	820	0.010	1,200	0.010
7/16	0.4375	580	0.009	530	0.007	400	0.006	700	0.011	970	0.011
1/2	0.5000	510	0.009	460	0.008	350	0.007	620	0.012	850	0.012
5/8	0.6250	410	0.011	370	0.010	280	0.008	490	0.014	680	0.014
23/32	0.7188	360	0.012	320	0.010	240	0.009	430	0.015	590	0.014
3/4	0.7500	340	0.013	310	0.011	230	0.009	410	0.015	570	0.015
7/8	0.8750	290	0.013	270	0.011	200	0.010	350	0.017	490	0.017
1	1.0000	260	0.014	230	0.012	180	0.011	310	0.018	430	0.018
1 1/4	1.2500	210	0.016	190	0.013	140	0.011	250	0.019	340	0.019
1 1/2	1.5000	170	0.017	160	0.014	120	0.012	210	0.021	290	0.021

1) The above values apply when coolant is used in a vertical machine. In a horizontal machine or deep hole, use pecking.

2) Adjust drilling condition when unusual vibration or different sound occurs.

Deep Hole Drilling Guide

Aqua Drill EX Oil Hole 10D, 15D, 20D, 25D, 30D, 40D, PLT

1. Use Guide Hole Drill (AQDEXOHPLT)

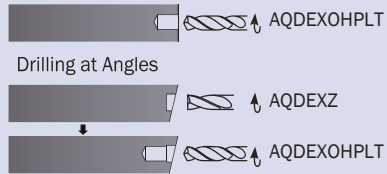

- We recommend pre-drilling with guide hole drill. Hole depth 1D - 2D
- We recommend using AQEXOHPLT for guide hole drilling. Select one with a diameter 0.015mm larger than deep hole drill
- If drilling at an angle use Aqua EX flat drill (AQDEXZ) to create a flat surface and then use Pilot Drill

2. Deep Hole Drilling into Guide Hole

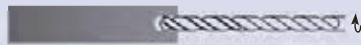

- Penetrate into the guide hole at 50% lower RPM until 0.5-1.0mm (0.02"-0.04") from depth of guide

3. Deep Hole Drilling



- Start Drilling at recommended Speeds & Feeds

4. Deep Hole Drilling (Breaking Thru or Blind Hole)

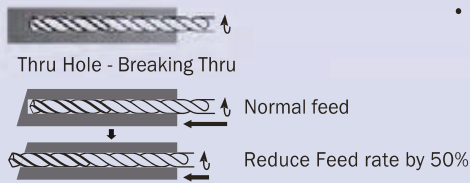

- When breaking thru for a thru hole reduce feed rate by 50% to prevent drill from breaking

5. Retracting Drill from the Hole

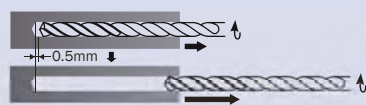

- After drilling is complete, decrease RPM and pull the drill back through the hole

Precautions for Small Diameter Drills

1. Handling of Cutting Fluid

- To prevent Coolant holes from being blocked use a fine mesh filter. (Recommended Filtration efficiency 5µm)
- Water Soluble cutting fluid is recommended

2. Minimum Coolant pressure requirement

- Minimum coolant pressure requirement = 300 psi or 2.0 Mpa
- Above recommended pressure will enable stable machining
- If using non-water soluble cutting oils, higher pressure might be required

3. ATC

- To reduce shock and vibration, reduce ATC feed if required

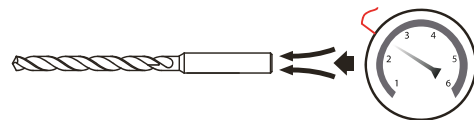

Recommended Coolant Pressure 1000 psi, Minimum 300 psi

GUIDELINES FOR TROUBLESHOOTING TWIST DRILL PROBLEMS

- Remedial measure is highly effective
- Remedial measure is relatively effective

DRILLS-TECHNICAL

Problems	Solution	Possible Cause									
		Trouble with device	Faulty jig, clamp, or fixture	Faulty tool (design)	Faulty tool (regrinding)	Faulty tool holder	Defect in workplace	Unsatisfactory cutting conditions	Faulty coolant or lubricating system	Faulty process design	
Oversize holes	Reduce material build up on cutting lips and flutes				22		24		29 30 31 32		
	Reduce difference in cutting resistance between right and left cutting lips		4 5B 7	13B	9 0 21	2 8					
Curved hole or drilled off center	Prevent defective leading	3	3 4 5B 7		13A 21	8		26B 27	6 33		
	Increase drill rigidity			10							
	Reduce difference in cutting resistance between right and left cutting lips				17B 19						
Distorted Holes	Prevent rifling		4		18B 19						
	Reduce irregular motion		3 7	23	20 21	8		26A		33	
	Eliminate clogging with chips			9A 11 14 15						34	
Hole position shift		3 4		20 21	8		27		33		
Rough Finish or tearing in hole	Reduce galling (material build up on cutting lips)				22		24		29 30 31 32		
	Reduce wear				13A 19			25B			
	Reduce chatter and vibration	1	4 7	9A 23	20 21			26A		33	
Breakage of drill	Eliminate clogging with chips			9A 11 14 15				26A 36		34	
	Increase drill rigidity			10 23	17			26B			
	Reduce feed at breakthrough	1 2	7		20 18			28			
	Prevent drill deflection		3 4 5B 7		13A 19 21			26B			
Abnormal wear of drill corner edge	Reduce wear			12 16	18A		24	25B 26B			
	Prevent drill deflection	2	7					26B			
Wrapping of chip around drill	Increase or decrease helix angle and cutting speed from the recommended angle and speed	34	5A	9 11 14				26A			

GUIDELINES FOR TROUBLESHOOTING TWIST DRILL PROBLEMS

No.	Remedial action and important points	No.	Remedial action and important points
1	Increase rigidity (column and spindle) of machine tool.	19	Eliminate relative lip height (difference in cutting resistance between right and left cutting edges).
2	Take steps to insure a steady feed (particularly components with pneumatic or hydraulic controls).	20	Thinning (take care to prevent excessive thinning).
3	Increase accuracy of alignment of bushing. (Increase alignment of preliminary hole and spindle for hole with large diameter.)	21	Eliminate unevenly chiseled areas.
		22	Rework worn margin completely.
4	Use bushing and reduce bushing clearance.	23	Increase web thickness.
5	Clearance between workpiece to be drilled and bushing	24	Check workpiece to be drilled, for proper grain structure and heat treatment. (HB: 180 or more)
5A:	Widen this clearance.		
5B:	Narrow this clearance.	25	Cutting speed
6	Rotate workpiece instead of tool.	25A:	Increase this speed.
7	Secure workpiece or replace fixture on the workpiece with fittings that have less clamp distortion.	25B:	Decrease this speed.
		26	Feed
8	Check contact of drill taper (clean) and reduce run-out of holder and spindle.	26A:	Increase feed rate.
		26B:	Decrease feed rate.
9	Helix angle	27	Decrease feed at entrance to workpiece.
		28	Decrease feed at exit from workpiece.
9A:	Increase this angle.	29	Use non-water-soluble coolant.
9B:	Decrease this angle.	30	Use sulfuric or chloric extreme-pressure oils.
10	Shorten overall length and flute length to Increase rigidity.	31	Increase quantity of coolant discharged.
		32	Feed oil in correct direction.
11	Provide chipbreaker.	33	Drill center hole in preceding process.
12	Use surface treatment.	34	Effect intermittent feed. (Narrow step for deep holes.)
13	Point angle	35	Select such helix angle and end angle that cutting
		36	Decrease feed rate for deep holes
13A:	Increase this angle		
13B:	Decrease this angle.		
14	Increase flute width ratio.		
15	Use oil-hole drill.		
16	Upgrade material of tool.		
17	Back taper		
17B:	Decrease back taper (Check a slight decrease in diameter from point to back).		
18	Lip relief angle		
18B:	Decrease this angle.		

TAPER SHANK WITH TENON

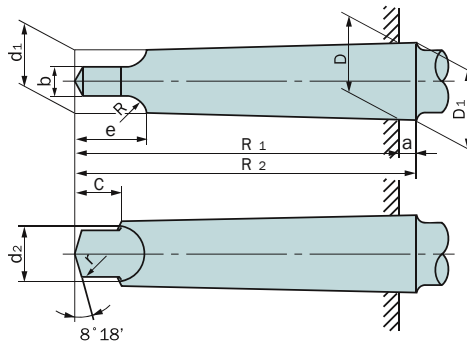

DRILLS-TECHNICAL

Morse taper	Taper		Angle on Side	Taper Shank with Tenon																					
				D ⁽²⁾	a	D ₁ ⁽³⁾	d ₁ ⁽³⁾	d ₂		R ₁		R ₂		b		C ⁽⁴⁾	e		R	r					
								Basic size	Tolerance	Basic size	Tolerance	Basic size	Tolerance	Basic size	Tolerance		Basic size	Tolerance							
																					Basic size	Tolerance	Max.		
0	1/19.212	0.05205	1°29'27"	9.045	3	9.201	6.104	6	0	-0.3	56.5	0	-1.2	59.5	0	-1.9	3.9	0	-0.180	6.5	10.5	0	-1.1	4	1
1	1/20.047	0.04988	1°25'43"	12.065	3.5	12.240	8.972	8.7	0	-0.3	62.0	0	-1.2	65.5	0	-1.9	5.2	0	-0.180	8.5	13.5	0	-1.1	5	1.2
2	1/20.020	0.04995	1°25'50"	17.780	5	18.030	14.034	13.5	0	-0.43	75.0	0	-1.2	80	0	-1.9	6.3	0	-0.220	10	16	0	-1.1	6	1.6
3	1/19.922	0.05020	1°26'16"	23.825	5	24.076	19.107	18.5	0	-0.52	94.0	0	-1.4	99	0	-2.2	7.9	0	-0.220	13	20	0	-1.3	7	2
4	1/19.254	0.05194	1°29'15"	31.267	6.5	31.605	25.164	24.5	0	-0.52	117.5	0	-1.4	124	0	-2.5	11.9	0	-0.270	16	24	0	-1.3	8	2.5
5	1/19.002	0.05263	1°30'26"	44.399	6.5	44.741	36.531	35.7	0	-0.62	149.5	0	-1.6	156	0	-2.5	15.9	0	-0.270	19	29	0	-1.3	10	3
6	1/19.180	0.05214	1°29'36"	63.348	8	63.765	52.399	51.0	0	-0.74	210.0	0	-1.85	218	0	-2.9	19	0	-0.330	27	40	0	-1.6	13	4

Tolerance of Drill Diameter

Unit : 0.001mm

Diameter (mm)		Under 3.0 D ≤ 3	Above 3.0 Under 6.0 3 < D ≤ 6	Above 6.0 Under 10 6 < D ≤ 10	Above 10 Under 18 10 < D ≤ 18	Above 18 Under 30 18 < D ≤ 30	Above 30 Under 50 30 < D ≤ 50	Above 50 Under 80 50 < D ≤ 80	Above 80 Under 120 80 < D ≤ 120
Tolerance	js6	±3	±4	±4.5	±5.5	±6.5	±8	±8.5	±11
	h6	0 -6	0 -8	0 -9	0 -11	0 -13	0 -16	0 -19	0 -22
	h7	0 -10	0 -12	0 -15	0 -18	0 -21	0 -25	0 -30	0 -35
	h8	0 -14	0 -18	0 -22	0 -27	0 -33	0 -39	0 -46	0 -54

NACHI

High Performance Carbide End Mills

Expanded Offering with New Diameters, Cut Lengths,
Corner Radius Sizes, and Neck Relieved Options

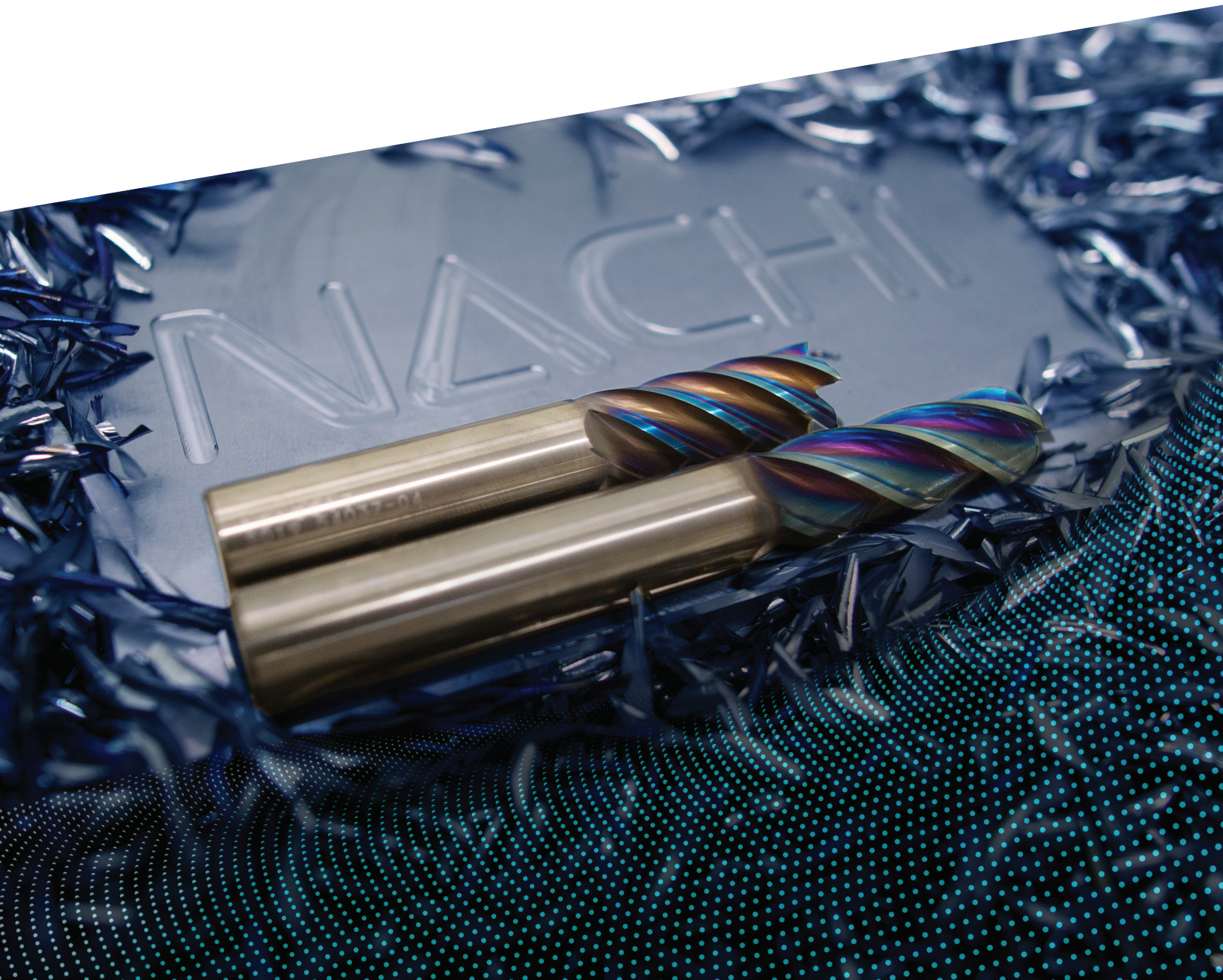

Aqua V Mill - 4 Flute

Offering

- 9701/9702 Square End
- 9703/9704 Corner Radius

**New
Sizes**

Features

- Variable helix, variable index to reduce vibrations and chatter
- Excellent at HSM/HEM
- Versatile across a range of materials
- Available in Square End, Corner Radius
- Aqua Mill Nano-layer Coating for high heat and wear resistance

Work Materials

- | | | |
|--------------|---------------------|---------------|
| • Cast Iron | • Carbon Steel | • Alloy Steel |
| • Tool Steel | • 300/400 Series SS | • PH SS |
| • Titanium | • High Temp Alloys | |

Performance

For High Performance Machining of a Range of Materials



CARBIDE END MILLS

Aqua V Mill - 5 Flute

Offering

- 9705/9706 Square End
- 9707/9708 Corner Radius
- 9709/9710 Ball Nose
- 9727 Square End Neck Relief

**New
Series &
Sizes**

Features

- Variable helix, variable index to reduce vibrations and chatter
- Excellent at HSM/HEM
- 5 Flute Design for faster feed rates and better surface finishes
- Available in Square End, Corner Radius and Ball End
- Aqua Mill Nano-layer Coating for high heat and wear resistance

Work Materials

- | | | |
|--------------|---------------------|---------------|
| • Cast Iron | • Carbon Steel | • Alloy Steel |
| • Tool Steel | • 300/400 Series SS | • PH SS |
| • Titanium | • High Temp Alloys | |

Performance

For High Performance Machining of a Range of Materials



Aqua Mill Hard

Offering

- 9711/9712 Square End
- 9713/9714 Corner Radius
- 9715/9716 Ball Nose
- 9729/9730 Corner Radius Neck Relief

**New
Sizes**

Features

- Excellent for HSM of hardened steels up to 70 HRC
- Thick core and wide land width for increased rigidity
- Available in Square End, Corner Radius, and Ball End
- Aqua Mill Nano-layer Coating for high heat and wear resistance

Work Materials

- Tool steels 50+ HRC
- Hardened Steels 50+ HRC
- High Speed Steels

Performance

For Machining Hard Materials 50-70 HRC



ALH Mill

Offering

- 9717/9718 Square End
- 9719/9720 Corner Radius
- 9721/9722 Ball Nose
- 9723 Square End Neck Relief
- 9725 Ball Nose Neck Relief

**New
Series &
Sizes**

Features

- Cylindrical land allows for great surface finishes and high feed rates
- 3 Flutes allow for faster feed rates while not sacrificing chip evacuation
- High polished flutes help shear and clear chips
- Available in Square End, Corner Radius, and Ball End
- Available with coating through our 72 hour modification service

Work Materials

- Aluminum alloys
- Aluminum castings
- Copper Alloys
- Magnesium

Performance











For Aluminum and Non-ferrous Materials



CARBIDE END MILLS

HIGH PERFORMANCE END MILLS

CARBIDE END MILLS

List No.	End Mill Name	Material	Coating	Stock Size	Product Page		
Aqua V Mill Series							
9701 9702	 4 Flute Square End	Carbide	Aqua Mill	Fractional 1/8 to 3/4 Metric 3.0 to 20.0	p. 162		
9703 9704	 4 Flute Corner Radius			Fractional 1/8 to 3/4 Metric 3.0 to 20.0	p. 163		
9705 9706	 5 Flute Square End			Fractional 1/8 to 3/4 Metric 3.0 to 20.0	p. 164		
9707 9708	 5 Flute Corner Radius			Fractional 1/8 to 3/4 Metric 3.0 to 20.0	p. 165-166		
9709 9710	 5 Flute Ball Nose			Fractional 1/8 to 3/4 Metric 3.0 to 20.0	p. 168		
9727	 5 Flute Neck Relieved			Fractional 1/8 to 3/4	p. 167		
Aqua Hard Mill Series							
9711 9712	 Square End			Carbide	Aqua Mill	Fractional 1/8 to 3/4 Metric 3.0 to 20.0	p. 171
9713 9714	 Corner Radius	Fractional 1/8 to 3/4 Metric 3.0 to 20.0	p. 172				
9715 9716	 Ball Nose	Fractional 1/8 to 3/4 Metric 3.0 to 20.0	p. 173				
9729 9730	 Corner Radius Neck Relief	Fractional 3/16 to 1/2 Metric 5.0 to 12.0	p. 174				
ALH Mill Series							
9717 9718	 Square End	Carbide	Bright			Fractional 1/8 to 3/4 Metric 3.0 to 20.0	p. 179
9719 9720	 Corner Radius			Fractional 1/8 to 3/4 Metric 3.0 to 20.0	p. 180-181		
9721 9722	 Ball Nose			Fractional 1/8 to 3/4 Metric 3.0 to 20.0	p. 182		
9723	 Square End Neck Relief			Fractional 1/8 to 3/4	p. 183		
9725	 Ball Nose Neck Relief			Fractional 1/8 to 3/4	p. 184		

















● : Great ○ : Good △ : OK - : Not Recommended

List No.	Cutting Condition Page	Workpiece Material																	
		Carbon Steel		Alloy Steel	Mold Steel	Hardened Steel				Stainless Steel		PH Stainless	Titanium Alloys	Nickel Alloys	Cast Iron		Aluminum		Copper Alloys
		Low Carbon	High Carbon			HRc				Austenitic 300 Series	Martensitic 400 Series				Soft <200HB	Hard >200HB	6061 7075	Cast	
				20 ~ 30	30 ~ 45	45 ~ 55	55 ~ 60	60 ~ 70											
Aqua V Mill Series																			
9701	p. 169-170	●	●	●	●	-	-	-	●	●	●	○	○	○	○	-	-	-	
9702		●	●	●	●	-	-	-	●	●	●	○	○	○	○	-	-	-	
9703	p. 169-170	●	●	●	●	-	-	-	●	●	●	○	○	○	○	-	-	-	
9704		●	●	●	●	-	-	-	●	●	●	○	○	○	○	-	-	-	
9705	p. 169	●	●	●	●	-	-	-	●	●	●	○	○	○	○	-	-	-	
9706		●	●	●	●	-	-	-	●	●	●	○	○	○	○	-	-	-	
9707	p. 169	●	●	●	●	-	-	-	●	●	●	○	○	○	○	-	-	-	
9708		●	●	●	●	-	-	-	●	●	●	○	○	○	○	-	-	-	
9709	p. 169	●	●	●	●	-	-	-	●	●	●	○	○	○	○	-	-	-	
9710		●	●	●	●	-	-	-	●	●	●	○	○	○	○	-	-	-	
9727	p. 169	●	●	●	●	-	-	-	●	●	●	○	○	○	○	-	-	-	
Aqua Hard Mill Series																			
9711	p. 175.176	-	-	-	-	●	●	●	-	-	-	-	○	-	-	-	-	-	
9712		-	-	-	-	●	●	●	-	-	-	-	○	-	-	-	-	-	
9713	p. 175-176	-	-	-	-	●	●	●	-	-	-	-	○	-	-	-	-	-	
9714		-	-	-	-	●	●	●	-	-	-	-	○	-	-	-	-	-	
9715	p. 177-178	-	-	-	-	●	●	●	-	-	-	-	○	-	-	-	-	-	
9716		-	-	-	-	●	●	●	-	-	-	-	○	-	-	-	-	-	
9729	p. 175-176	-	-	-	-	●	●	●	-	-	-	-	○	-	-	-	-	-	
9730		-	-	-	-	●	●	●	-	-	-	-	○	-	-	-	-	-	
ALH Mill Series																			
9717	p. 185-188	-	-	-	-	-	-	-	-	-	-	-	-	-	-	●	●	●	
9718		-	-	-	-	-	-	-	-	-	-	-	-	-	-	●	●	●	
9719	p. 185-188	-	-	-	-	-	-	-	-	-	-	-	-	-	-	●	●	●	
9120		-	-	-	-	-	-	-	-	-	-	-	-	-	-	●	●	●	
9721	p. 185-188	-	-	-	-	-	-	-	-	-	-	-	-	-	-	●	●	●	
9722		-	-	-	-	-	-	-	-	-	-	-	-	-	-	●	●	●	
9723	p. 185-188	-	-	-	-	-	-	-	-	-	-	-	-	-	-	●	●	●	
9725	p. 185-188	-	-	-	-	-	-	-	-	-	-	-	-	-	-	●	●	●	

CARBIDE END MILLS

HIGH PERFORMANCE END MILLS

CARBIDE END MILLS

List No.	End Mill Name	Material	Coating	Stock Size	Product Page
DLC Mill Series					
6231HD	 2 Flute	HSCO	DLC	Fractional 1/8 to 1	p. 189
AG Mill Series					
6485	 Rougher	HSCO	AG	Fractional 1/4 to 2	p. 190
6403	 Heavy Rougher	HSCO	AG	Fractional 1/4 to 2	p. 191
SG Mill Series					
6367X	 Roughing & Finishing	HSCO	SG	Fractional 1/4 to 2	p. 192
6303X	 Roughing			Fractional 1/4 to 2	p. 14
6231X	 2 Flute			Fractional 1/8 to 1-1/2	p. 197
6211X	 Multi-Flute			Fractional 1/8 to 1-1/2	p. 201
High Speed Steel Cobalt Mill Series					
6367	 Roughing & Finishing	HSCO	Black Oxide	Fractional 1/4 to 3	p. 192
6303	 Roughing		Fractional 1/4 to 2	p. 194	
6307	 Roughing		Fractional 1/4 to 2	p. 195	
6231	 2 Flute		Fractional 1/8 to 2	p. 197	
6233	 2 Flute Long		Fractional 1/4 to 2	p. 198	
6230	 2 Flute		Fractional 1.0 to 30.0	p. 198	
6210	 4 Flute		Fractional 2.5 to 50.0	p. 200	
6211M	 Multi-Flute		Fractional 1/8 to 2	p. 201	
6213	 Multi-Flute Long		Fractional 1/4 to 1-1/4	p. 202	

● : Great ○ : Good Δ : OK - : Not Recommended

List No.	Cutting Condition Page	Workpiece Material																
		Carbon Steel		Alloy Steel 20 ~ 30	Mold Steel 30 ~ 45	Hardened Steel			Stainless Steel		PH Stainless	Titanium Alloys	Nickel Alloys	Cast Iron		Aluminum		Copper Alloys
		Low Carbon	High Carbon			HRc			Austenitic 300 Series	Martensitic 400 Series				Soft <200HB	Hard >200HB	6061 7075	Cast	
				45 ~ 55	55 ~ 60	60 ~ 70												
DLC Mill Series																		
6231HD	p. 189	-	-	-	-	-	-	-	-	-	-	-	-	-	●	●	○	
AG Mill Series																		
6485	p. 190	●	●	○	-	-	-	-	-	-	-	-	Δ	Δ	Δ	Δ	Δ	
6403	p. 191	●	●	○	-	-	-	-	-	-	-	-	Δ	Δ	Δ	Δ	Δ	
SG Mill Series																		
6367X	p. 193	●	●	○	-	-	-	-	-	-	-	-	Δ	Δ	Δ	Δ	Δ	
6303X	p. 196	●	●	○	-	-	-	-	-	-	-	-	Δ	Δ	Δ	Δ	Δ	
6231X	p. 199	●	●	○	-	-	-	-	-	-	-	-	Δ	Δ	Δ	Δ	Δ	
6211X	p. 204	●	●	○	-	-	-	-	-	-	-	-	Δ	Δ	Δ	Δ	Δ	
High Speed Steel Cobalt Mill Series																		
6367	p. 193	○	○	○	-	-	-	-	-	-	-	-	○	○	Δ	Δ	○	
6303	p. 196	○	○	○	-	-	-	-	-	-	-	-	○	○	Δ	Δ	○	
6307	p. 196	○	○	○	-	-	-	-	-	-	-	-	○	○	Δ	Δ	○	
6231	p. 199	○	○	○	-	-	-	-	-	-	-	-	○	○	Δ	Δ	○	
6233	p. 199	○	○	○	-	-	-	-	-	-	-	-	○	○	Δ	Δ	○	
6230	p. 199	○	○	○	-	-	-	-	-	-	-	-	○	○	Δ	Δ	○	
6210	p. 203	○	○	○	-	-	-	-	-	-	-	-	○	○	Δ	Δ	○	
6211M	p. 203	○	○	○	-	-	-	-	-	-	-	-	○	○	Δ	Δ	○	
6213	p. 203	○	○	○	-	-	-	-	-	-	-	-	○	○	Δ	Δ	○	

CARBIDE END MILLS

HIGH PERFORMANCE END MILLS

Aqua V Mill - 4 Flute

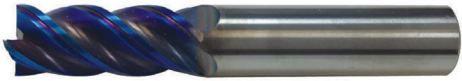

List No. 9701

Fractional Sizes

Shank Size Matches Cutting Diameter

EDP#	Cutting Diameter	Length of Cut	Overall Length	Flutes
41000409	1/8	1/4	1-1/2	4
41000138	1/8	3/8	1-1/2	
41000410	1/8	1/2	2	
41000411	5/32	3/16	2	
41000412	5/32	7/16	2	
41000413	3/16	5/16	2	
41000139	3/16	7/16	2	
41000140	1/4	1/2	2-1/2	
41000583	1/4	3/4	2-1/2	
41000415	1/4	1	3	
41000416	5/16	1/2	2	
41000141	5/16	13/16	2-1/2	
41000417	5/16	1	3	
41000418	3/8	1/2	2	
41000142	3/8	7/8	2-1/2	
41000419	3/8	1	3	
41000143	3/8	1-1/8	3	
41000420	1/2	5/8	2-1/2	
41000144	1/2	1	3	
41000145	1/2	1-1/4	3-1/4	
41000421	1/2	1-5/8	4	
41000422	5/8	3/4	3	
41000146	5/8	1-1/4	3-1/2	
41000423	5/8	2	4	
41000424	3/4	7/8	3	
41000147	3/4	1-1/2	4	
41000425	3/4	2-1/4	5	

List No. 9702

Metric Sizes

EDP#	Cutting Diameter	Length of Cut	Overall Length	Flutes
41000001	3	8	57	4
41000002	4	11	57	
41000003	5	11	57	
41000004	6	13	57	
41000005	8	19	70	
41000006	10	22	70	
41000007	12	26	75	
41000008	16	32	90	
41000009	18	38	100	
41000010	20	45	100	

1 per tube

⚠ WARNING: Cancer - www.P65Warnings.ca.gov

HIGH PERFORMANCE END MILLS

Aqua V Mill - 4 Flute Corner Radius

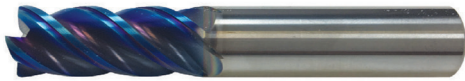

List No. 9703

Fractional Sizes

Shank Size Matches Cutting Diameter

EDP#	Cutting Diameter	Length of Cut	Overall Length	0.010 CR	0.015 CR	0.030 CR	0.060 CR	0.090 CR	0.120 CR	Flutes
41000469	1/8	1/4	1-1/2	X						4
41000470	1/8	3/8	1-1/2	X						
41000181	1/8	3/8	1-1/2		X					
41000471	1/8	1/2	2			X				
41000472	3/16	5/16	2		X					
41000182	3/16	7/16	2			X				
41000473	3/16	7/16	2		X					
41000183	1/4	1/2	2-1/2			X				
41000474	1/4	1/2	2-1/2		X					
41000475	1/4	3/4	2-1/2		X					
41000476	1/4	1	3			X				
41000477	5/16	1/2	2-1/2		X					
41000184	5/16	13/16	2-1/2			X				
41000478	5/16	1	3				X			
41000479	3/8	1/2	2		X					
41000185	3/8	7/8	2-1/2			X				
41000480	3/8	7/8	2-1/2				X			
41000481	3/8	1	3					X		
41000482	1/2	5/8	2-1/2		X					
41000186	1/2	1	3			X				
41000187	1/2	1-1/4	3-1/4			X				
41000483	1/2	1-1/4	3-1/4					X		
41000189	1/2	1	3				X			
41000190	1/2	1	3						X	
41000484	5/8	3/4	3			X				
41000191	5/8	1-1/4	3-1/2			X				
41000192	5/8	1-1/4	3-1/2				X			
41000485	5/8	1-1/4	3-1/2					X		
41000193	5/8	1-1/4	3-1/2						X	
41000486	5/8	2	4			X				
41000487	3/4	7/8	3			X				
41000194	3/4	1-1/2	4			X				
41000195	3/4	1-1/2	4				X			
41000488	3/4	1-1/2	4					X		
41000196	3/4	1-1/2	4						X	

List No. 9704

Metric Sizes

EDP#	Cutting Diameter	Length of Cut	Overall Length	0.3 CR	0.5 CR	1.0 CR	2.0 CR	Flutes
41000021	3	8	57	X				4
41000022	4	11	57	X				
41000023	5	11	57		X			
41000024	6	13	57		X			
41000025	8	19	70		X			
41000026	8	19	70			X		
41000027	10	22	80		X			
41000028	10	22	80			X		
41000029	12	26	90		X			
41000030	12	26	90			X		
41000031	12	26	90				X	
41000032	16	32	90			X		
41000033	16	32	90				X	
41000034	18	38	100			X		
41000035	18	38	100				X	
41000036	20	45	100				X	

1 per tube

⚠ WARNING: Cancer - www.P65Warnings.ca.gov

HIGH PERFORMANCE END MILLS

Aqua V Mill - 5 Flute

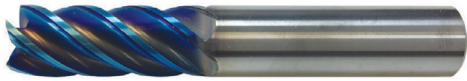

List No. 9705

Fractional Sizes

Shank Size Matches Cutting Diameter

EDP#	Cutting Diameter	Length of Cut	Overall Length	Flutes
41000148	1/8	1/4	1-1/2	5
41000149	1/8	1/2	1-1/2	
41000150	1/8	3/4	2-1/2	
41000426	5/32	3/16	2	
41000427	5/32	7/16	2	
41000151	3/16	5/16	2	
41000152	3/16	9/16	2	
41000153	3/16	3/4	2-1/2	
41000154	1/4	3/8	2	
41000428	1/4	1/2	2-1/2	
41000155	1/4	3/4	2-1/2	
41000156	1/4	1-1/8	3	
41000157	5/16	7/16	2	
41000158	5/16	13/16	2-1/2	
41000159	5/16	1-1/4	3	
41000160	5/16	2-1/8	4	
41000161	3/8	1/2	2	
41000162	3/8	1	2-1/2	

EDP#	Cutting Diameter	Length of Cut	Overall Length	Flutes
41000163	3/8	1-1/4	3	5
41000164	3/8	1-5/8	4	
41000165	3/8	2-1/2	6	
41000166	1/2	5/8	2-1/2	
41000167	1/2	1	3	
41000168	1/2	1-1/4	3	
41000169	1/2	1-5/8	4	
41000170	1/2	2-1/8	4	
41000171	1/2	3-1/4	6	
41000172	5/8	3/4	3	
41000173	5/8	1-5/8	3-1/2	
41000174	5/8	2-1/8	4	
41000175	5/8	2-5/8	5	
41000176	5/8	3-1/4	6	
41000177	3/4	1	3	
41000178	3/4	1-5/8	4	
41000179	3/4	2-3/8	5	
41000180	3/4	3-1/4	6	

CARBIDE END MILLS

List No. 9706

Metric Sizes

EDP#	Cutting Diameter	Length of Cut	Overall Length	Flutes
41000011	3	8	57	5
41000012	4	11	57	
41000013	5	11	57	
41000014	6	13	57	
41000015	8	19	70	
41000016	10	22	70	
41000017	12	26	75	
41000018	16	32	90	
41000019	18	38	100	
41000020	20	45	100	

1 per tube

⚠ WARNING: Cancer - www.P65Warnings.ca.gov

HIGH PERFORMANCE END MILLS

Aqua V Mill - 5 Flute Corner Radius

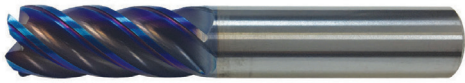

List No. 9707

Fractional Sizes

Shank Size Matches Cutting Diameter

EDP#	Cutting Diameter	Length of Cut	Overall Length	0.010 CR	0.015 CR	0.020 CR	0.030 CR	0.060 CR	0.090 CR	0.120 CR	0.125 CR	Flutes
41000197	1/8	1/4	1-1/2		X							5
41000489	1/8	1/4	1-1/2	X								
41000198	1/8	1/2	1-1/2		X							
41000490	1/8	1/2	1-1/2	X								
41000491	1/8	1/2	1-1/2				X					
41000199	1/8	3/4	2-1/2		X							
41000589	3/16	5/16	2	X								
41000492	3/16	5/16	2		X							
41000200	3/16	5/16	2				X					
41000201	3/16	9/16	2				X					
41000578	3/16	5/8	2		X							
41000202	3/16	3/4	2-1/2				X					
41000493	1/4	3/8	2		X							
41000494	1/4	3/8	2				X					
41000203	1/4	3/8	2					X				
41000495	1/4	1/2	2-1/2				X					
41000496	1/4	1/2	2-1/2					X				
41000497	1/4	1/2	2-1/2						X			
41000204	1/4	3/4	2-1/2					X				
41000205	1/4	1-1/8	3					X				
41000498	5/16	7/16	2		X							
41000206	5/16	7/16	2				X					
41000207	5/16	7/16	2					X				
41000499	5/16	7/16	2						X			
41000500	5/16	13/16	2-1/2		X							
41000208	5/16	13/16	2-1/2				X					
41000209	5/16	13/16	2-1/2					X				
41000210	5/16	1-1/4	3				X					
41000211	5/16	2-1/8	4				X					
41000590	3/8	1/2	2	X								
41000501	3/8	1/2	2		X							
41000212	3/8	1/2	2				X					
41000213	3/8	1/2	2					X				
41000502	3/8	1/2	2						X			
41000580	3/8	1/2	2-1/2		X							
41000579	3/8	7/8	2-1/2			X						
41000503	3/8	1	2-1/2		X							
41000214	3/8	1	2-1/2				X					
41000215	3/8	1	2-1/2					X				
41000504	3/8	1	2-1/2						X			
41000216	3/8	1	2-1/2							X		
41000217	3/8	1-1/4	3					X				
41000218	3/8	1-5/8	4					X				
41000219	3/8	2-1/2	6					X				
41000591	1/2	5/8	2-1/2	X								
41000505	1/2	5/8	2-1/2		X							
41000220	1/2	5/8	2-1/2				X					
41000221	1/2	5/8	2-1/2					X				
41000506	1/2	5/8	2-1/2						X			

(cont. on next page)

HIGH PERFORMANCE END MILLS

Aqua V Mill - 5 Flute Corner Radius (cont.)



List No. L9707

Fractional Sizes

EDP#	Cutting Diameter	Length of Cut	Overall Length	0.010 CR	0.015 CR	0.020 CR	0.030 CR	0.060 CR	0.090 CR	0.120 CR	0.125 CR	Flutes
41000222	1/2	5/8	2-1/2							X		5
41000507	1/2	1	3		X							
41000223	1/2	1	3				X					
41000224	1/2	1	3					X				
41000508	1/2	1	3						X			
41000225	1/2	1	3							X		
41000585	1/2	1-1/4	3		X							
41000226	1/2	1-1/4	3				X					
41000577	1/2	1-1/4	3								X	
41000227	1/2	1-5/8	4				X					
41000228	1/2	2-1/8	4				X					
41000229	1/2	3-1/4	6				X					
41000509	5/8	3/4	3		X							
41000230	5/8	3/4	3				X					
41000231	5/8	3/4	3					X				
41000510	5/8	3/4	3						X			
41000511	5/8	3/4	3							X		
41000232	5/8	1-5/8	3-1/2				X					
41000233	5/8	1-5/8	3-1/2					X				
41000234	5/8	1-5/8	3-1/2							X		
41000235	5/8	2-1/8	4				X					
41000236	5/8	2-5/8	5				X					
41000237	5/8	3-1/4	6				X					
41000512	3/4	1	3		X							
41000238	3/4	1	3				X					
41000239	3/4	1	3					X				
41000513	3/4	1	3						X			
41000240	3/4	1	3							X		
41000241	3/4	1-5/8	4				X					
41000242	3/4	1-5/8	4					X				
41000514	3/4	1-5/8	4						X			
41000243	3/4	1-5/8	4							X		
41000244	3/4	2-3/8	5				X					
41000245	3/4	3-1/4	6				X					

List No. L9708

Metric Sizes

EDP#	Cutting Diameter	Length of Cut	Overall Length	0.3 CR	0.5 CR	1.0 CR	2.0 CR	Flutes
41000037	3	8	57	X				5
41000038	4	11	57	X				
41000039	5	11	57		X			
41000040	6	13	57		X			
41000041	8	19	70		X			
41000042	8	19	70			X		
41000043	10	22	80		X			
41000044	10	22	80			X		
41000045	12	26	90		X			
41000046	12	26	90			X		
41000047	12	26	90				X	
41000048	16	32	90			X		
41000049	16	32	90				X	
41000050	18	38	100			X		
41000051	18	38	100				X	
41000052	20	45	100				X	

1 per tube

⚠ WARNING: Cancer - www.P65Warnings.ca.gov

HIGH PERFORMANCE END MILLS

Aqua V Mill - 5 Flute Neck Relief



List No. 9727

Fractional Sizes

Shank Size Matches Cutting Diameter

EDP#	Size	Length of Cut	Neck Diameter	Neck Length	Overall Length	Flutes
41000447	1/8	5/32	0.118	3/4	2-1/2	5
41000448	1/8	5/32	0.118	1	2-1/2	
41000449	3/16	7/32	0.178	3/4	3	
41000450	3/16	7/32	0.178	1-1/8	3	
41000451	1/4	3/8	0.237	1-1/8	4	
41000452	1/4	3/8	0.237	1-5/8	4	
41000454	3/8	1/2	0.356	1-5/8	4	
41000455	3/8	1/2	0.356	2-1/8	4	
41000456	3/8	1/2	0.356	2-1/2	5	
41000458	1/2	5/8	0.475	1-3/4	4	
41000459	1/2	5/8	0.475	2-1/4	4	
41000460	1/2	5/8	0.475	2-3/4	5	
41000463	5/8	3/4	0.593	2-3/8	6	
41000464	5/8	3/4	0.593	3-3/8	6	
41000466	3/4	1	0.712	2-1/2	6	
41000467	3/4	1	0.712	2-7/8	6	

1 per tube

⚠ WARNING: Cancer - www.P65Warnings.ca.gov

CARBIDE END MILLS

HIGH PERFORMANCE END MILLS

Aqua V Mill - 5 Flute Ball Nose



List No. 9709

Fractional Sizes

Shank Size Matches Cutting Diameter

EDP#	Size	Length of Cut	Overall Length	Flutes
41000246	1/8	1/4	1-1/2	5
41000247	1/8	1/2	1-1/2	
41000248	1/8	3/4	2-1/2	
41000249	3/16	5/16	2	
41000250	3/16	9/16	2	
41000251	3/16	3/4	2-1/2	
41000252	1/4	3/8	2	
41000253	1/4	3/4	2-1/2	
41000254	1/4	1-1/8	3	
41000255	5/16	7/16	2	
41000256	5/16	13/16	2-1/2	
41000257	5/16	1-1/4	3	
41000258	3/8	1/2	2	
41000259	3/8	1	2-1/2	
41000260	3/8	1-1/4	3	

EDP#	Size	Length of Cut	Overall Length	Flutes
41000261	3/8	1-5/8	3-1/2	5
41000262	3/8	1-5/8	6	
41000263	1/2	5/8	2-1/2	
41000264	1/2	1	3	
41000265	1/2	1-1/4	3	
41000266	1/2	1-5/8	4	
41000267	1/2	1-5/8	6	
41000268	5/8	3/4	3	
41000269	5/8	1-5/8	3-1/2	
41000270	5/8	2-1/8	4	
41000271	5/8	2-1/8	6	
41000272	3/4	1	3	
41000273	3/4	1-5/8	4	
41000274	3/4	2-3/8	5	
41000275	3/4	2-3/8	6	

CARBIDE END MILLS

List No. 9710

Metric Sizes

EDP#	Size	Length of Cut	Overall Length	Flutes
41000053	3	8	57	5
41000054	4	11	57	
41000055	5	11	57	
41000056	6	13	57	
41000057	8	19	70	
41000058	10	22	90	
41000059	12	26	90	
41000060	16	32	100	
41000061	18	38	100	
41000062	20	45	100	

1 per tube

⚠ WARNING: Cancer - www.P65Warnings.ca.gov

HIGH PERFORMANCE END MILLS

Standard Milling Conditions Aqua V Mill 4 & 5 Flute Series Profile Roughing

List No. 9701, 9702, 9703, 9704, 9705, 9706, 9707, 9708, 9709, 9710, 9727

Mill Dia.	Radial WOC		Work Material								
			Cast Irons	Carbon Steel (1018/1020)	Alloy Steels 4130/4140	Tool Steels < 40 HRC	Stainless Steels 400 series	Stainless Steels 300 series	Stainless Steels PH	Titanium	High Temp Alloys
			425-475 SFM	400-450 SFM	350-400 SFM	350-400 SFM	350-400 SFM	300-350 SFM	275-325 SFM	225-275 SFM	75-125 SFM
3	Ar	RPM	14550	13750	12150	12150	12150	10500	9700	8100	3250
		5%	0.0023	0.0023	0.0018	0.0015	0.0015	0.0018	0.0015	0.0015	0.0015
		10%	0.0016	0.0016	0.0013	0.0011	0.0011	0.0013	0.0011	0.0011	0.0011
1/8	Ar	RPM	13750	13000	11450	11450	11450	9900	9200	7650	3050
		5%	0.0023	0.0023	0.0018	0.0018	0.0018	0.0018	0.0015	0.0015	0.0018
		10%	0.0016	0.0016	0.0013	0.0013	0.0013	0.0013	0.0011	0.0011	0.0013
4	Ar	RPM	10900	10300	9100	9100	9100	7900	7300	6100	2400
		5%	0.0028	0.0028	0.0023	0.0020	0.0020	0.0023	0.0018	0.0018	0.0023
		10%	0.0020	0.0020	0.0016	0.0014	0.0014	0.0016	0.0013	0.0013	0.0016
3/16	Ar	RPM	9150	8700	7650	7650	7650	6600	6100	5100	2000
		5%	0.0033	0.0033	0.0028	0.0025	0.0025	0.0028	0.0023	0.0023	0.0025
		10%	0.0023	0.0023	0.0020	0.0018	0.0018	0.0020	0.0016	0.0016	0.0018
5	Ar	RPM	8750	8250	7300	7300	7300	6300	5800	4850	1950
		5%	0.0033	0.0033	0.0028	0.0028	0.0028	0.0030	0.0023	0.0023	0.0028
		10%	0.0023	0.0023	0.0020	0.0020	0.0020	0.0022	0.0016	0.0018	0.0020
6	Ar	RPM	7300	6900	6100	6100	6100	5250	4850	4050	1600
		5%	0.0038	0.0038	0.0033	0.0033	0.0033	0.0035	0.0028	0.0028	0.0033
		10%	0.0027	0.0027	0.0023	0.0023	0.0023	0.0025	0.0020	0.0020	0.0023
1/4	Ar	RPM	6900	6500	5700	5700	5700	5000	4600	3800	1500
		5%	0.0040	0.0040	0.0035	0.0033	0.0033	0.0038	0.0030	0.0030	0.0035
		10%	0.0029	0.0029	0.0025	0.0023	0.0023	0.0027	0.0022	0.0022	0.0025
5/16	Ar	RPM	5500	5200	4600	4600	4600	4000	3700	3050	1200
		5%	0.0048	0.0048	0.0043	0.0043	0.0043	0.0045	0.0035	0.0038	0.0043
		10%	0.0034	0.0034	0.0031	0.0031	0.0031	0.0032	0.0025	0.0027	0.0031
8	Ar	RPM	5500	5200	4600	4600	4600	4000	3700	3050	1200
		5%	0.0048	0.0048	0.0043	0.0043	0.0043	0.0045	0.0035	0.0038	0.0043
		10%	0.0034	0.0034	0.0031	0.0031	0.0031	0.0032	0.0025	0.0027	0.0031
3/8	Ar	RPM	4600	4300	3800	3800	3800	3300	3050	2550	1000
		5%	0.0058	0.0058	0.0053	0.0050	0.0050	0.0055	0.0040	0.0045	0.0050
		10%	0.0041	0.0041	0.0038	0.0036	0.0036	0.0040	0.0029	0.0032	0.0036
10	Ar	RPM	4350	4100	3600	3600	3600	3150	2900	2400	970
		5%	0.0060	0.0060	0.0055	0.0053	0.0053	0.0058	0.0043	0.0048	0.0053
		10%	0.0043	0.0043	0.0040	0.0038	0.0038	0.0041	0.0031	0.0034	0.0038
7/16	Ar	RPM	3900	3700	3300	3300	3300	2800	2600	2200	870
		5%	0.0065	0.0065	0.0060	0.0058	0.0058	0.0065	0.0048	0.0053	0.0060
		10%	0.0047	0.0047	0.0043	0.0041	0.0041	0.0047	0.0034	0.0038	0.0043
12	Ar	RPM	3600	3400	3000	3000	3000	2600	2400	2000	800
		5%	0.0070	0.0070	0.0065	0.0063	0.0063	0.0070	0.0050	0.0055	0.0065
		10%	0.0050	0.0050	0.0047	0.0045	0.0045	0.0050	0.0036	0.0040	0.0047
1/2	Ar	RPM	3400	3250	2850	2850	2850	2500	2300	1900	760
		5%	0.0073	0.0073	0.0068	0.0065	0.0065	0.0073	0.0055	0.0060	0.0068
		10%	0.0052	0.0052	0.0049	0.0047	0.0047	0.0052	0.0040	0.0043	0.0049
9/16	Ar	RPM	3050	2900	2550	2550	2550	2200	2000	1700	680
		5%	0.0083	0.0083	0.0078	0.0075	0.0075	0.0083	0.0060	0.0063	0.0075
		10%	0.0059	0.0059	0.0056	0.0054	0.0054	0.0059	0.0043	0.0045	0.0054
5/8	Ar	RPM	2750	2600	2300	2300	2300	2000	1800	1500	600
		5%	0.0090	0.0090	0.0085	0.0083	0.0083	0.0093	0.0068	0.0070	0.0085
		10%	0.0065	0.0065	0.0061	0.0059	0.0059	0.0067	0.0049	0.0050	0.0061
16	Ar	RPM	2750	2600	2300	2300	2300	2000	1800	1500	600
		5%	0.0090	0.0090	0.0085	0.0083	0.0083	0.0093	0.0068	0.0070	0.0085
		10%	0.0065	0.0065	0.0061	0.0059	0.0059	0.0067	0.0049	0.0050	0.0061
3/4	Ar	RPM	2300	2150	1900	1900	1900	1650	1500	1300	500
		5%	0.0108	0.0108	0.0103	0.0098	0.0098	0.0110	0.0080	0.0083	0.0103
		10%	0.0077	0.0077	0.0074	0.0070	0.0070	0.0079	0.0058	0.0059	0.0074
20	Ar	RPM	2200	2050	1800	1800	1800	1550	1450	1200	480
		5%	0.0113	0.0113	0.0108	0.0103	0.0103	0.0115	0.0083	0.0085	0.0108
		10%	0.0081	0.0081	0.0077	0.0074	0.0074	0.0083	0.0059	0.0061	0.0077
		RPM	0.0045	0.0045	0.0043	0.0041	0.0041	0.0046	0.0033	0.0034	0.0043

CARBIDE END MILLS

Depth Of Cut = Aa For applications with radial engagement > 15% of tool diameter, please use a max 1.5XD for depth of cut.

D: Dia. Of Mill Side Milling

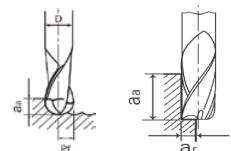

- For slotting, it is recommended to use Aqua V Mill 4 Flute. Please refer to slotting speed/feed chart.
- For Entry, it is recommended to reduce RPM and IPT by 50%.
- When using long reach, neck relieved tools, decrease width of cut and feed rate by 50%.
- Adjust milling condition when unusual vibration or sound occurs.
- For finishing parameters, please use 0.01XD WOC, max SFM shown on chart, and IPT value shown at 30% engagement.
- If assistance is needed please reach out to the cutting tools technical team.

HIGH PERFORMANCE END MILLS

Standard Milling Conditions

Aqua V Mill 4 Flute Series Slotting

List No. 9701, 9702, 9703, and 9704

CARBIDE END MILLS

Mill Diameter		Work Material								
		Cast Irons	Carbon Steel 1018/1020	Medium Alloy Steels 4130/4140	Tool Steels <40 HRC	Stainless Steels 400 series	Stainless Steels 300 series	Stainless Steels PH	Titanium	High Temp Alloys
		325-375 SFM	325-375 SFM	275-325 SFM	275-325 SFM	275-325 SFM	250-300 SFM	225-275 SFM	225-275 SFM	60-80 SFM
3	RPM	11300	11300	9700	9700	9700	8900	8100	8100	1950
	IPT	0.0005	0.0006	0.0006	0.0006	0.0006	0.0006	0.0005	0.0005	0.0005
1/8	RPM	10700	10700	9150	8400	8400	8400	7650	7650	1850
	IPT	0.0006	0.0007	0.0006	0.0006	0.0006	0.0007	0.0005	0.0005	0.0005
4	RPM	8500	8500	7300	7300	7300	6700	6700	6100	1450
	IPT	0.0007	0.0008	0.0008	0.0008	0.0008	0.0008	0.0007	0.0007	0.0007
3/16	RPM	7100	7100	6100	6100	6100	5600	5100	5100	1200
	IPT	0.0008	0.0010	0.0009	0.0009	0.0009	0.0010	0.0008	0.0008	0.0008
5	RPM	6800	6800	5800	5800	5800	5350	4850	4850	1150
	IPT	0.0008	0.0011	0.0009	0.0009	0.0009	0.0011	0.0008	0.0008	0.0008
6	RPM	5650	5650	4850	4850	4850	4500	4050	4050	970
	IPT	0.0011	0.0013	0.0011	0.0011	0.0011	0.0013	0.0010	0.0010	0.0010
1/4	RPM	5350	5350	4600	4600	4600	4200	3800	3800	920
	IPT	0.0011	0.0013	0.0011	0.0011	0.0011	0.0013	0.0010	0.0010	0.0010
5/16	RPM	4300	4300	3700	3700	3700	3350	3050	3050	730
	IPT	0.0014	0.0017	0.0015	0.0015	0.0015	0.0017	0.0013	0.0013	0.0013
8	RPM	4300	4300	3700	3700	3700	3350	3050	3050	730
	IPT	0.0014	0.0017	0.0015	0.0015	0.0015	0.0017	0.0013	0.0013	0.0013
3/8	RPM	3550	3550	3050	3050	3050	2800	2550	2550	610
	IPT	0.0017	0.0020	0.0018	0.0018	0.0018	0.0020	0.0015	0.0016	0.0016
10	RPM	3400	3400	2900	2900	2900	2650	2400	2400	580
	IPT	0.0018	0.0021	0.0019	0.0019	0.0019	0.0021	0.0016	0.0016	0.0016
7/16	RPM	3050	3050	2600	2600	2600	2400	2200	2200	520
	IPT	0.0019	0.0023	0.0021	0.0021	0.0021	0.0023	0.0018	0.0018	0.0018
12	RPM	2800	2800	2400	2400	2400	2200	2000	2000	480
	IPT	0.0021	0.0025	0.0023	0.0023	0.0023	0.0025	0.0019	0.0019	0.0020
1/2	RPM	2650	2650	2300	2300	2300	2100	1900	1900	460
	IPT	0.0022	0.0026	0.0024	0.0024	0.0024	0.0026	0.0020	0.0020	0.0021
9/16	RPM	2400	2400	2000	2000	2000	1850	1700	1700	400
	IPT	0.0025	0.0030	0.0027	0.0027	0.0027	0.0030	0.0023	0.0023	0.0024
5/8	RPM	2150	2150	1800	1800	1800	1700	1500	1500	370
	IPT	0.0028	0.0033	0.0030	0.0030	0.0030	0.0033	0.0025	0.0025	0.0026
16	RPM	2150	2150	1800	1800	1800	1700	1500	1500	370
	IPT	0.0028	0.0033	0.0030	0.0030	0.0030	0.0033	0.0025	0.0025	0.0026
3/4	RPM	1800	1800	1500	1500	1500	1400	1250	1250	310
	IPT	0.0033	0.0039	0.0036	0.0036	0.0036	0.0039	0.0030	0.0030	0.0031
20	RPM	1700	1700	1450	1450	1450	1350	1200	1200	290
	IPT	0.0035	0.0041	0.0038	0.0038	0.0038	0.0041	0.0032	0.0032	0.0033
DOC	H	0.5D			0.25D					0.15D
	D	1.0D								

D: Dia. Of Mill Slotting

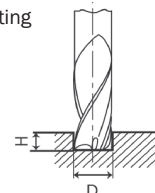

- Adjust milling condition when unusual vibration or sound occurs.
- When using long reach tools, decrease depth of cut and feed rate by 50%.
- If assistance is needed please reach out to the cutting tools technical team.

HIGH PERFORMANCE END MILLS

Aqua Mill Hard



List No. 9711 Fractional Sizes Shank Size Matches Cutting Diameter

EDP#	Cutting Diameter	Length of Cut	Overall Length	Flutes
41000276	1/8	3/8	1-1/2	6
41000277	3/16	7/16	2	
41000278	1/4	5/8	2-1/2	
41000279	5/16	13/16	2-1/2	
41000280	3/8	1	3	
41000281	1/2	1-1/8	3	
41000282	5/8	1-1/2	4	8
41000283	3/4	1-3/4	4	

List No. 9712 Metric Sizes

EDP#	Cutting Diameter	Length of Cut	Overall Length	Flutes
41000063	3	8	50	6
41000064	4	11	50	
41000065	5	13	50	
41000066	6	13	50	
41000067	8	19	63	
41000068	10	22	70	
41000069	12	26	75	
41000070	16	32	93	8
41000071	20	38	150	

1 per tube

⚠ WARNING: Cancer - www.P65Warnings.ca.gov

CARBIDE END MILLS

HIGH PERFORMANCE END MILLS

Aqua Mill Hard Corner Radius

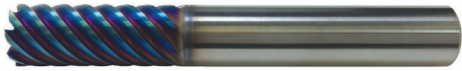

List No. 9713

Fractional Sizes

Shank Size Matches Cutting Diameter

EDP#	Cutting Diameter	Length of Cut	Overall Length	0.015 CR	0.030 CR	0.060 CR	Flutes
41000284	1/8	3/8	1-1/2	X			6
41000285	3/16	7/16	2	X			
41000586	3/16	7/16	2			X	
41000286	1/4	5/8	2-1/2	X			
41000587	1/4	5/8	2-1/2			X	
41000287	5/16	13/16	2-1/2	X			
41000288	3/8	1	3		X		
41000289	1/2	1-1/8	3		X		
41000588	1/2	1-1/8	3			X	
41000403	3/4	1-3/4	4			X	8

CARBIDE END MILLS

List No. 9714

Metric Sizes

EDP#	Cutting Diameter	Length of Cut	Overall Length	0.3 CR	0.5 CR	Flutes
41000072	3	8	50	X		6
41000074	4	11	50	X		
41000076	5	13	63	X		
41000078	6	13	63	X		
41000080	8	19	65	X		
41000083	10	22	70		X	
41000085	12	26	75		X	

1 per tube

⚠ WARNING: Cancer - www.P65Warnings.ca.gov

HIGH PERFORMANCE END MILLS

Aqua Mill Hard Ball Nose



List No. 9715

Fractional Sizes

Shank Size Matches Cutting Diameter

EDP#	Cutting Diameter	Length of Cut	Overall Length	Flutes
41000298	1/8	3/16	2-1/2	2
41000299	3/16	9/32	2-1/2	
41000300	1/4	3/8	2-1/2	
41000301	5/16	15/32	2-1/2	
41000302	3/8	9/16	3	
41000303	1/2	5/8	4	

List No. 9716

Metric Sizes

EDP#	Cutting Diameter	Length of Cut	Overall Length	Flutes
41000093	3	3	50	2
41000094	6	6	76	
41000095	8	8	90	
41000096	10	10	100	
41000097	12	12	100	
41000098	16	16	100	

1 per tube

⚠ WARNING: Cancer - www.P65Warnings.ca.gov

CARBIDE END MILLS

HIGH PERFORMANCE END MILLS

Aqua Hard Mill Corner Radius - Neck Relief



List No. 9729

Fractional Sizes

Shank Size Matches Cutting Diameter

EDP#	Cutting Diameter	Length of Cut	Neck Length	Overall Length	0.015 CR	Flutes
41000292	3/16	7/32	1	3	X	6
41000293	1/4	9/32	1	3	X	
41000294	3/8	15/32	1-1/4	3-1/2	X	
41000295	1/2	5/8	2-1/4	4	X	

List No. 9730

Fractional Sizes

EDP#	Cutting Diameter	Length of Cut	Neck Length	Overall Length	0.3 CR	Flutes
41000088	5	8	15	63	X	6
41000089	6	9	20	63	X	
41000091	10	15	30	100	X	
41000092	12	18	35	100	X	

1 per tube

WARNING: Cancer - www.P65Warnings.ca.gov

CARBIDE END MILLS

HIGH PERFORMANCE END MILLS

Standard Milling Conditions Conventional

List No: 9711, 9712, 9713, 9714, 9729, 9730

Mill Diameter		Work Material			
		Hardened Steel 45-55 HRC	Hardened Steel 55-60 HRC	Hardened Steel 60-65 HRC	Hardened Steel 65-70 HRC
		280-320 SFM	220-250 SFM	200-220 SFM	140-160 SFM
3	RPM	10400	8200	7400	5200
	IPT	0.0007	0.0005	0.0005	0.0005
1/8	RPM	9200	7200	6400	4600
	IPT	0.0007	0.0006	0.0006	0.0005
4	RPM	7300	5700	5100	3600
	IPT	0.0010	0.0009	0.0008	0.0008
3/16	RPM	6100	4800	4300	3050
	IPT	0.0014	0.0011	0.0010	0.0010
5	RPM	5800	4500	4100	2900
	IPT	0.0014	0.0011	0.0010	0.0010
6	RPM	5200	4100	3700	2600
	IPT	0.0016	0.0013	0.0012	0.0012
1/4	RPM	4900	3850	3500	2450
	IPT	0.0017	0.0014	0.0013	0.0013
5/16	RPM	3900	3050	2800	1950
	IPT	0.0022	0.0017	0.0016	0.0016
8	RPM	3900	3050	2800	1950
	IPT	0.0022	0.0017	0.0016	0.0016
3/8	RPM	3250	2600	2300	1650
	IPT	0.0026	0.0020	0.0019	0.0019
10	RPM	3100	2450	2200	1550
	IPT	0.0028	0.0022	0.0020	0.0020
12	RPM	2600	2050	1850	1300
	IPT	0.0033	0.0026	0.0024	0.0024
1/2	RPM	2450	1950	1750	1250
	IPT	0.0035	0.0027	0.0025	0.0025
5/8	RPM	1950	1550	1400	980
	IPT	0.0041	0.0032	0.0030	0.0029
16	RPM	1950	1550	1400	980
	IPT	0.0041	0.0032	0.0030	0.0029
3/4	RPM	1650	1300	1150	820
	IPT	0.0045	0.0036	0.0032	0.0032
20	RPM	1450	1150	1000	780
	IPT	0.0046	0.0038	0.0034	0.0034
Depth of Cut	Aa	1-1.5D			
	Ar	0.07D		0.02D	
	H	0.07D		0.05D - Max 0.5mm	

- Recommended to run dry with air blow only.
- When altering depth of cut or speed, it is important to read chips in order to ensure that heat is coming off in chip.
- Adjust milling condition when unusual vibration or sound occurs.
- When using long reach tools, decrease the width of cut and feed rate by 50%.
- Conventional conditions are recommended for finishing

CARBIDE END MILLS

HIGH PERFORMANCE END MILLS

Standard Milling Conditions High Speed

List No: 9711, 9712, 9713, 9714, 9729, 9730

CARBIDE END MILLS

Mill Diameter		Work Material		
		Hardened Steel 45-55 HRC	Hardened Steel 55-60 HRC	Hardened Steel 60-65 HRC
		800-1000 SFM	600-740 SFM	400-450 SFM
3	RPM	32000	24000	13900
	IPT	0.0010	0.0007	0.0008
1/8	RPM	27500	20500	13150
	IPT	0.0012	0.0009	0.0009
4	RPM	24000	18000	10400
	IPT	0.0016	0.0012	0.0013
3/16	RPM	20100	15100	8700
	IPT	0.0020	0.0015	0.0015
5	RPM	19200	14400	8300
	IPT	0.0021	0.0015	0.0016
6	RPM	16000	12000	6950
	IPT	0.0024	0.0018	0.0018
1/4	RPM	15100	11500	6600
	IPT	0.0025	0.0018	0.0019
5/16	RPM	12000	9000	5250
	IPT	0.0032	0.0023	0.0025
8	RPM	12000	9000	5200
	IPT	0.0032	0.0023	0.0025
3/8	RPM	10000	7500	4400
	IPT	0.0038	0.0028	0.0030
10	RPM	9600	7200	4200
	IPT	0.0040	0.0029	0.0031
12	RPM	8000	6000	3500
	IPT	0.0048	0.0035	0.0039
1/2	RPM	7550	5750	3300
	IPT	0.0050	0.0037	0.0042
5/8	RPM	6000	4500	2600
	IPT	0.0059	0.0044	0.0050
16	RPM	6000	4500	2600
	IPT	0.0059	0.0044	0.0050
3/4	RPM	5000	3750	2200
	IPT	0.0063	0.0046	0.0055
20	RPM	4800	3600	2100
	IPT	0.0067	0.0049	0.0058
Depth of Cut	Aa	1-1.5D		
	Ar	0.03D		0.02D

D: Dia. Of Mill

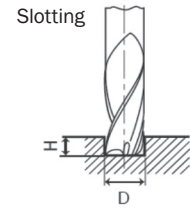
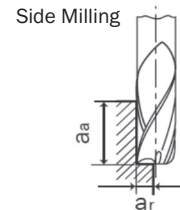

- Recommended to run dry with air blow only.
- When altering depth of cut or speed, it is important to read chips in order to ensure that heat is coming off in chip.
- Adjust milling condition when unusual vibration or sound occurs.
- When using long reach tools, decrease the width of cut and feed rate by 50%.
- Conventional conditions are recommended for finishing

HIGH PERFORMANCE END MILLS

Standard Milling Conditions Roughing

List No. 9715, 9716

Mill Diameter		Work Material		
		Hardened Steel 45-55 HRC	Hardened Steel 55-60 HRC	Hardened Steel 60-65 HRC
		320-350 SFM	250-280 SFM	200-250 SFM
3	RPM	11000	8600	7400
	IPT	0.0016	0.0012	0.0011
1/8	RPM	10400	8100	6900
	IPT	0.0017	0.0013	0.0012
4	RPM	8250	6450	5600
	IPT	0.0022	0.0018	0.0016
3/16	RPM	6900	5400	4700
	IPT	0.0026	0.0020	0.0018
5	RPM	660	5150	4450
	IPT	0.0027	0.0021	0.0019
6	RPM	5500	4300	3700
	IPT	0.0032	0.0025	0.0023
1/4	RPM	5200	4050	3500
	IPT	0.0034	0.0026	0.0024
5/16	RPM	4150	3200	2800
	IPT	0.0042	0.0033	0.0030
8	RPM	4150	3200	2800
	IPT	0.0042	0.0033	0.0030
3/8	RPM	3500	2700	2350
	IPT	0.0049	0.0040	0.0036
10	RPM	3300	2600	2250
	IPT	0.0050	0.0042	0.0038
12	RPM	2800	2150	1850
	IPT	0.0060	0.0050	0.0045
1/2	RPM	2600	2000	1800
	IPT	0.0063	0.0053	0.0048
5/8	RPM	2100	1600	1400
	IPT	0.0079	0.0066	0.0060
16	RPM	2100	1600	1400
	IPT	0.0079	0.0066	0.0060
3/4	RPM	1750	1350	1200
	IPT	0.0080	0.0067	0.0060
20	RPM	1650	1300	1100
	IPT	0.0082	0.0069	0.0062
Depth of Cut	Aa	0.025"-0.035"		0.015"-0.025"
	Pf	0.25D		

D: Dia. Of Mill
R: Ball Radius

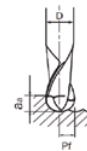

- Recommended to run dry with air blow.
- When altering depth of cut or speed, it is important to read chips in order to ensure that the heat is being removed in the chip.
- Adjust milling condition when unusual vibration or sound occurs.
- When using long reach tools, decrease the width of cut and feed rate by 50%

CARBIDE END MILLS

HIGH PERFORMANCE END MILLS

Standard Milling Conditions High Speed Finishing

List No. 9715, 9716

Standard Milling Conditions Low Speed Finishing

List No. 9715, 9716

CARBIDE END MILLS

Mill Diameter		Work Material		
		Hardened Steel 45-55 HRC	Hardened Steel 55-60 HRC	Hardened Steel 60-65 HRC
		800-1000 SFM	700-900 SFM	600-800 SFM
3	RPM	29100	25900	22600
	IPT	0.0024	0.0014	0.0014
1/8	RPM	27500	24500	21400
	IPT	0.0025	0.0015	0.0015
4	RPM	21800	19400	17000
	IPT	0.0028	0.0016	0.0016
3/16	RPM	18300	16300	14300
	IPT	0.0028	0.0017	0.0017
5	RPM	17500	15500	13600
	IPT	0.0029	0.0017	0.0017
6	RPM	14550	13000	11300
	IPT	0.0031	0.0019	0.0019
1/4	RPM	13750	12200	10700
	IPT	0.0032	0.0019	0.0019
5/16	RPM	11000	9800	8550
	IPT	0.0034	0.0021	0.0021
8	RPM	10900	9700	8500
	IPT	0.0034	0.0021	0.0021
3/8	RPM	9150	8150	7100
	IPT	0.0038	0.0024	0.0024
10	RPM	8700	7800	6800
	IPT	0.0039	0.0024	0.0024
12	RPM	7300	6450	5650
	IPT	0.0041	0.0027	0.0027
1/2	RPM	6900	6100	5350
	IPT	0.0042	0.0028	0.0028
5/8	RPM	5500	4900	4300
	IPT	0.0049	0.0033	0.0033
16	RPM	5500	4900	4300
	IPT	0.0049	0.0033	0.0033
3/4	RPM	4600	4100	3550
	IPT	0.0056	0.0037	0.0037
20	RPM	4400	3900	3400
	IPT	0.0058	0.0039	0.0039
Depth of Cut	Aa	0.025"-0.035"	0.015"-0.025"	
	Pf	0.005"		

Mill Diameter		Work Material		
		Hardened Steel 45-55 HRC	Hardened Steel 55-60 HRC	Hardened Steel 60-65 HRC
		245-275 SFM	150-180 SFM	120-150 SFM
3	RPM	8400	5350	4350
	IPT	0.0007	0.0006	0.0006
1/8	RPM	7950	5050	4100
	IPT	0.0007	0.0006	0.0006
4	RPM	6300	4000	3300
	IPT	0.0010	0.0007	0.0007
3/16	RPM	5300	3400	2750
	IPT	0.0010	0.0009	0.0009
5	RPM	5050	3200	2600
	IPT	0.0011	0.0009	0.0009
6	RPM	4200	2650	2200
	IPT	0.0013	0.0010	0.0010
1/4	RPM	4000	2500	2050
	IPT	0.0013	0.0011	0.0011
5/16	RPM	3200	2000	1650
	IPT	0.0016	0.0014	0.0014
8	RPM	3200	2000	1650
	IPT	0.0016	0.0014	0.0014
3/8	RPM	2650	1700	1400
	IPT	0.0019	0.0016	0.0016
10	RPM	2500	1600	1300
	IPT	0.0020	0.0017	0.0017
12	RPM	2100	1350	1100
	IPT	0.0024	0.0020	0.0020
1/2	RPM	2000	1250	1050
	IPT	0.0025	0.0021	0.0021
5/8	RPM	1600	1000	830
	IPT	0.0031	0.0026	0.0026
16	RPM	1600	1000	830
	IPT	0.0031	0.0026	0.0026
3/4	RPM	1300	850	700
	IPT	0.0037	0.0031	0.0031
20	RPM	1250	800	650
	IPT	0.0039	0.0033	0.0033
Depth of Cut	Aa	0.005"		
	Pf	0.005"		

- Recommended to run dry with air blow.
- When altering depth of cut or speed, it is important to read chips in order to ensure that the heat is being removed in the chip.
- Adjust milling condition when unusual vibration or sound occurs.
- When using long reach tools, decrease the width of cut and feed rate by 50%

D: Dia. Of Mill
R: Ball Radius

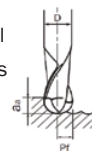

HIGH PERFORMANCE END MILLS

ALH Mill



List No. 9717

Fractional Sizes

Shank Size Matches Cutting Diameter

EDP#	Cutting Diameter	Length of Cut	Overall Length	Flutes
41000304	1/8	1/4	1-1/2	3
41000305	1/8	3/8	2	
41000306	1/8	1/2	2-1/2	
41000515	1/8	3/4	2-1/2	
41000307	3/16	5/16	2	
41000308	3/16	9/16	2-1/2	
41000516	3/16	3/4	2-1/2	
41000309	1/4	3/8	2	
41000310	1/4	1/2	2-1/2	
41000311	1/4	5/8	2-1/2	
41000312	1/4	1	3	
41000517	1/4	1-1/4	3	
41000313	5/16	7/16	2	
41000314	5/16	5/8	2-1/2	
41000315	5/16	1	3	
41000316	5/16	1-1/4	3	
41000317	3/8	1/2	2	
41000518	3/8	3/4	2-1/2	

EDP#	Cutting Diameter	Length of Cut	Overall Length	Flutes
41000318	3/8	1	3	3
41000319	3/8	1-1/4	3-1/2	
41000320	3/8	1-1/2	4	
41000321	3/8	2	4	
41000322	1/2	5/8	2-1/2	
41000323	1/2	1	3	
41000324	1/2	1-1/4	3	
41000325	1/2	1-5/8	4	
41000326	1/2	2	4	
41000327	1/2	2-1/2	5	
41000328	5/8	3/4	3	
41000519	5/8	1-1/4	3-1/2	
41000329	5/8	1-5/8	3-1/2	
41000330	5/8	2-1/8	4	
41000331	3/4	1	4	
41000332	3/4	1-5/8	4	
41000333	3/4	2-1/4	5	

CARBIDE END MILLS

List No. 9718

Metric Sizes

EDP#	Cutting Diameter	Length of Cut	Overall Length	Flutes
41000100	3	8	57	3
41000101	4	11	57	
41000102	5	11	57	
41000103	6	13	57	
41000104	8	19	70	
41000105	10	22	70	
41000106	12	26	75	
41000107	12	32	94	
41000108	16	32	90	
41000109	18	38	90	
41000110	20	45	100	

1 per tube

⚠ WARNING: Cancer - www.P65Warnings.ca.gov

HIGH PERFORMANCE END MILLS

ALH Mill Corner Radius



List No. 9719

Fractional Sizes

Shank Size Matches Cutting Diameter

EDP#	Cutting Diameter	Length of Cut	Overall Length	0.015 CR	0.20 CR	0.030 CR	0.060 CR	0.090 CR	0.120 CR	Flutes
41000334	1/8	1/4	1-1/2	X						3
41000539	1/8	1/4	1-1/2			X				
41000335	1/8	3/8	2	X						
41000540	1/8	3/8	2			X				
41000336	1/8	1/2	2-1/2	X						
41000541	3/16	5/16	2	X						
41000337	3/16	5/16	2			X				
41000542	3/16	9/16	2-1/2	X						
41000338	3/16	9/16	2-1/2			X				
41000543	1/4	3/8	2	X						
41000339	1/4	3/8	2			X				
41000340	1/4	3/8	2				X			
41000544	1/4	1/2	2-1/2	X						
41000341	1/4	1/2	2-1/2			X				
41000545	1/4	1/2	2-1/2				X			
41000546	1/4	1	3	X						
41000345	5/16	7/16	2			X				
41000346	5/16	7/16	2				X			
41000347	5/16	5/8	2-1/2			X				
41000348	5/16	1	3			X				
41000349	5/16	1	3				X			
41000350	5/16	1-1/4	3			X				
41000547	3/8	1/2	2	X						
41000351	3/8	1/2	2			X				
41000352	3/8	1/2	2				X			
41000548	3/8	1/2	2					X		
41000353	3/8	1/2	2						X	
41000549	3/8	1	3	X						
41000402	3/8	1	3		X					
41000354	3/8	1	3			X				
41000355	3/8	1	3				X			
41000550	3/8	1	3					X		
41000356	3/8	1	3						X	
41000357	3/8	1-1/4	3-1/2				X			
41000358	3/8	1-1/2	4				X			
41000359	3/8	2	4			X				
41000551	1/2	5/8	2-1/2	X						
41000360	1/2	5/8	2-1/2			X				
41000361	1/2	5/8	2-1/2				X			
41000552	1/2	5/8	2-1/2					X		
41000362	1/2	5/8	2-1/2						X	

(cont. on next page)

CARBIDE END MILLS

HIGH PERFORMANCE END MILLS

ALH Mill Corner Radius (cont.)



List No. 9719

Fractional Sizes

Shank Size Matches Cutting Diameter

EDP#	Cutting Diameter	Length of Cut	Overall Length	0.015 CR	0.20 CR	0.030 CR	0.060 CR	0.090 CR	0.120 CR	Flutes
41000553	1/2	1	3	X						3
41000363	1/2	1	3			X				
41000364	1/2	1	3				X			
41000554	1/2	1	3					X		
41000365	1/2	1	3						X	
41000366	1/2	1-1/4	3			X				
41000584	1/2	1-1/4	3					X		
41000367	1/2	1-5/8	4			X				
41000368	1/2	2	4			X				
41000369	1/2	2-1/2	5			X				
41000555	5/8	3/4	3			X				
41000370	5/8	3/4	3				X			
41000556	5/8	3/4	3					X		
41000371	5/8	3/4	3						X	
41000372	5/8	1-5/8	3-1/2				X			
41000557	5/8	1-5/8	3-1/2					X		
41000373	5/8	1-5/8	3-1/2						X	
41000374	5/8	2-1/8	4			X				
41000375	5/8	2-1/2	5			X				
41000376	3/4	1	4				X			
41000558	3/4	1	4					X		
41000377	3/4	1	4						X	
41000378	3/4	1-5/8	4				X			
41000379	3/4	1-5/8	4						X	
41000380	3/4	2-1/4	5			X				
41000381	3/4	3-1/4	6			X				

List No. 9720

Metric Sizes

EDP#	Cutting Diameter	Length of Cut	Overall Length	0.3 CR	0.5 CR	1.0 CR	2.0 CR	Flutes
41000111	3	8	57	X				3
41000112	4	11	57	X				
41000113	5	11	57	X				
41000114	6	13	57	X				
41000115	6	13	57		X			
41000116	8	19	70		X			
41000117	8	19	70			X		
41000118	10	22	70		X			
41000119	10	22	70			X		
41000120	12	26	75		X			
41000121	12	26	75			X		
41000123	16	32	90			X		
41000124	16	32	90				X	
41000126	18	38	90				X	
41000128	20	45	100				X	

1 per tube

⚠ WARNING: Cancer - www.P65Warnings.ca.gov

HIGH PERFORMANCE END MILLS

ALH Mill Ball Nose



List No. 9721

Fractional Sizes

Shank Size Matches Cutting Diameter

EDP#	Cutting Diameter	Length of Cut	Overall Length	Flutes
41000382	1/8	1/4	1-1/2	3
41000383	1/8	3/8	2	
41000384	1/8	1/2	2-1/2	
41000385	3/16	3/8	2	
41000386	3/16	3/4	2-1/2	
41000387	3/16	1	3	
41000388	1/4	3/8	2	
41000389	1/4	3/4	2-1/2	
41000390	1/4	1	3	
41000391	5/16	13/16	2-1/2	
41000392	3/8	1/2	2	
41000393	3/8	1	2-1/2	
41000394	3/8	1-1/2	3-1/2	
41000395	1/2	5/8	2-1/2	
41000396	1/2	1	3	
41000397	1/2	1-1/4	3-1/2	
41000398	5/8	1	3	
41000399	5/8	1-5/8	4-1/2	
41000400	3/4	1	3	
41000401	3/4	1-5/8	4	

CARBIDE END MILLS

List No. L9722

Metric Sizes

EDP#	Cutting Diameter	Length of Cut	Overall Length	Flutes
41000129	3	8	57	3
41000130	4	11	57	
41000131	5	11	57	
41000132	6	13	57	
41000133	8	19	70	
41000134	10	22	70	
41000135	12	26	75	
41000136	16	32	90	
41000137	18	38	100	

1 per tube

⚠ WARNING: Cancer - www.P65Warnings.ca.gov

HIGH PERFORMANCE END MILLS

ALH Mill - Neck Relief

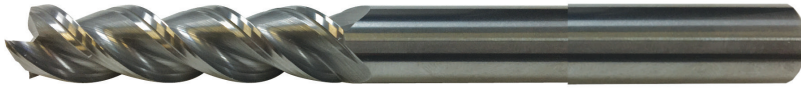

List No. 9723

Fractional Sizes

Shank Size Matches Cutting Diameter

EDP#	Cutting Diameter	Length of Cut	Neck Diameter	Neck Length	Overall Length	Flutes
41000520	1/8	5/32	0.118	3/4	3	3
41000521	1/8	5/32	0.118	1	3	
41000522	3/16	7/32	0.178	3/4	3	
41000523	3/16	7/32	0.178	1	3	
41000524	1/4	3/8	0.237	1-1/8	3	
41000525	1/4	3/8	0.237	1-5/8	3	
41000527	3/8	1/2	0.356	1-5/8	3	
41000528	3/8	1/2	0.356	2-1/8	4	
41000530	1/2	5/8	0.475	1-3/4	3-1/2	
41000531	1/2	5/8	0.475	2-1/4	4	
41000532	1/2	5/8	0.475	2-3/4	4-1/2	
41000533	1/2	5/8	0.475	3-3/8	5	
41000535	5/8	3/4	0.593	2-3/8	4	
41000536	5/8	3/4	0.593	3-3/8	6	
41000537	3/4	1	0.712	2-1/2	5	
41000538	3/4	1	0.712	3-3/8	6	

1 per tube

⚠ WARNING: Cancer - www.P65Warnings.ca.gov

CARBIDE END MILLS

ALH Mill Ball Nose - Neck Relief



List No. 9725

Fractional Sizes

Shank Size Matches Cutting Diameter

EDP#	Cutting Diameter	Length of Cut	Neck Diameter	Neck Length	Overall Length	Flutes
41000559	1/8	5/32	0.118	3/4	3	3
41000560	1/8	5/32	0.118	1	3	
41000561	3/16	7/32	0.178	3/4	3	
41000562	3/16	7/32	0.178	1	3	
41000563	1/4	3/8	0.237	1-1/8	3	
41000564	1/4	3/8	0.237	1-5/8	3	
41000566	3/8	1/2	0.356	1-5/8	3	
41000567	3/8	1/2	0.356	2-1/8	4	
41000569	1/2	5/8	0.475	1-3/4	3-1/2	
41000570	1/2	5/8	0.475	2-1/4	4	
41000571	1/2	5/8	0.475	2-3/4	4-1/2	
41000573	5/8	3/4	0.593	2-3/8	4	
41000574	5/8	3/4	0.593	3-3/8	6	
41000575	3/4	1	0.712	2	4	
41000576	3/4	1	0.712	3-3/8	6	

1 per tube

⚠ WARNING: Cancer - www.P65Warnings.ca.gov

CARBIDE END MILLS

HIGH PERFORMANCE END MILLS

Standard Milling Conditions

ALH 3 Flute Series

Profile Roughing

List No. 9717, 9718, 9719, 9720, 9721, 9722, 9723, 9725

Mill Dia.	Radial WOC		Work Material		
			Aluminum Alloys 2024, 6061, 7075	Aluminum Cast	Copper Alloys, Brass, Bronze
			950-1050 SFM	650-750 SFM	525-625 SFM
3	Ar	RPM	32300	22600	18600
	5%	IPT	0.0034	0.0030	0.0030
	10%		0.0025	0.0022	0.0022
	25%		0.0017	0.0015	0.0015
	50%		0.0015	0.0013	0.0013
1/8	Ar	RPM	30600	21400	17600
	5%	IPT	0.0037	0.0032	0.0032
	10%		0.0027	0.0023	0.0023
	25%		0.0018	0.0016	0.0016
	50%		0.0016	0.0014	0.0014
4	Ar	RPM	24300	17000	14000
	5%	IPT	0.0046	0.0041	0.0039
	10%		0.0033	0.0030	0.0028
	25%		0.0023	0.0021	0.0020
	50%		0.0020	0.0018	0.0017
3/16	Ar	RPM	20400	14300	11700
	5%	IPT	0.0055	0.0048	0.0048
	10%		0.0040	0.0035	0.0035
	25%		0.0028	0.0024	0.0024
	50%		0.0024	0.0021	0.0021
5	Ar	RPM	19400	13600	11200
	5%	IPT	0.0060	0.0050	0.0050
	10%		0.0043	0.0037	0.0037
	25%		0.0030	0.0025	0.0025
	50%		0.0026	0.0022	0.0022
6	Ar	RPM	16200	11300	9300
	5%	IPT	0.0071	0.0060	0.0060
	10%		0.0052	0.0043	0.0043
	25%		0.0036	0.0030	0.0030
	50%		0.0031	0.0026	0.0026
1/4	Ar	RPM	15300	10700	8800
	5%	IPT	0.0076	0.0064	0.0064
	10%		0.0055	0.0047	0.0047
	25%		0.0038	0.0032	0.0032
	50%		0.0033	0.0028	0.0028
5/16	Ar	RPM	12200	8550	7000
	5%	IPT	0.0094	0.0078	0.0078
	10%		0.0068	0.0057	0.0057
	25%		0.0047	0.0039	0.0039
	50%		0.0041	0.0034	0.0034
8	Ar	RPM	12200	8550	7000
	5%	IPT	0.0094	0.0080	0.0080
	10%		0.0068	0.0058	0.0058
	25%		0.0047	0.0040	0.0040
	50%		0.0041	0.0035	0.0035
3/8	Ar	RPM	10200	7100	5850
	5%	IPT	0.0112	0.0094	0.0094
	10%		0.0082	0.0068	0.0068
	25%		0.0057	0.0047	0.0047
	50%		0.0049	0.0041	0.0041

Mill Dia.	Radial WOC		Work Material		
			Aluminum Alloys 2024, 6061, 7075	Aluminum Cast	Copper Alloys, Brass, Bronze
			950-1050 SFM	650-750 SFM	525-625 SFM
10	Ar	RPM	9700	6800	5600
	5%	IPT	0.0119	0.0099	0.0099
	10%		0.0087	0.0072	0.0072
	25%		0.0060	0.0050	0.0050
	50%		0.0052	0.0043	0.0043
7/16	Ar	RPM	8700	6100	5000
	5%	IPT	0.0133	0.0110	0.0110
	10%		0.0097	0.0080	0.0080
	25%		0.0067	0.0055	0.0055
	50%		0.0058	0.0048	0.0048
12	Ar	RPM	8100	5650	4650
	5%	IPT	0.0142	0.0117	0.0119
	10%		0.0103	0.0085	0.0087
	25%		0.0072	0.0059	0.0060
	50%		0.0062	0.0051	0.0052
1/2	Ar	RPM	7600	5300	4400
	5%	IPT	0.0151	0.0124	0.0126
	10%		0.0110	0.0090	0.0092
	25%		0.0076	0.0062	0.0064
	50%		0.0066	0.0054	0.0055
9/16	Ar	RPM	6800	4800	3900
	5%	IPT	0.0170	0.0140	0.0142
	10%		0.0123	0.0102	0.0103
	25%		0.0085	0.0070	0.0072
	50%		0.0074	0.0061	0.0062
5/8	Ar	RPM	6100	4300	3500
	5%	IPT	0.0190	0.0156	0.0158
	10%		0.0138	0.0113	0.0115
	25%		0.0096	0.0079	0.0080
	50%		0.0083	0.0068	0.0069
16	Ar	RPM	6100	4300	3500
	5%	IPT	0.0190	0.0156	0.0158
	10%		0.0138	0.0113	0.0115
	25%		0.0096	0.0079	0.0080
	50%		0.0083	0.0068	0.0069
3/4	Ar	RPM	5100	3550	2900
	5%	IPT	0.0227	0.0186	0.0190
	10%		0.0165	0.0135	0.0138
	25%		0.0114	0.0094	0.0096
	50%		0.0099	0.0081	0.0083
20	Ar	RPM	4850	3400	2800
	5%	IPT	0.0239	0.0195	0.0200
	10%		0.0173	0.0142	0.0145
	25%		0.0120	0.0098	0.0100
	50%		0.0104	0.0085	0.0087
Depth Of Cut = Aa		If Radial Engagement is > 15% of Tool Diameter, Please Use Max 1.5D			

CARBIDE END MILLS

- For entry, it is recommended to use slotting conditions.
- Adjust milling condition when unusual vibration or sound occurs.
- When using long reach tools, decrease width of cut and feed rate by 50%.
- For Finishing, please use 0.01D WOC, Max SFM shown on chart, and the IPT value for 50% stepover.

HIGH PERFORMANCE END MILLS

Standard Milling Conditions For Spindle Under 10K RPM Profile Roughing

List No. 9717, 9718, 9719, 9720, 9721, 9722, 9723, 9725

CARBIDE END MILLS

Mill Diameter	Radial WOC		Work Material		
			Aluminum Alloys 2024, 6061, 7075	Aluminum Cast	Copper Alloys, Brass, Bronze
3	Ar	RPM	10000	10000	10000
	5%	IPT	0.0034	0.0030	0.0030
	10%		0.0025	0.0022	0.0022
	25%		0.0017	0.0015	0.0015
	50%		0.0015	0.0013	0.0013
1/8	Ar	RPM	10000	10000	10000
	5%	IPT	0.0037	0.0032	0.0032
	10%		0.0027	0.0023	0.0023
	25%		0.0018	0.0016	0.0016
	50%		0.0016	0.0014	0.0014
4	Ar	RPM	10000	10000	10000
	5%	IPT	0.0046	0.0041	0.0039
	10%		0.0033	0.0030	0.0028
	25%		0.0023	0.0021	0.0020
	50%		0.0020	0.0018	0.0017
3/16	Ar	RPM	10000	10000	10000
	5%	IPT	0.0055	0.0048	0.0048
	10%		0.0040	0.0035	0.0035
	25%		0.0028	0.0024	0.0024
	50%		0.0024	0.0021	0.0021
5	Ar	RPM	10000	10000	10000
	5%	IPT	0.0060	0.0050	0.0050
	10%		0.0043	0.0037	0.0037
	25%		0.0030	0.0025	0.0025
	50%		0.0026	0.0022	0.0022
6	Ar	RPM	10000	10000	
	5%	IPT	0.0071	0.0060	
	10%		0.0052	0.0043	
	25%		0.0036	0.0030	
	50%		0.0031	0.0026	
1/4	Ar	RPM	10000	10000	
	5%	IPT	0.0076	0.0064	
	10%		0.0055	0.0047	
	25%		0.0038	0.0032	
	50%		0.0033	0.0028	
5/16	Ar	RPM	10000		
	5%	IPT	0.0094		
	10%		0.0068		
	25%		0.0047		
	50%		0.0041		
8	Ar	RPM	10000		
	5%	IPT	0.0094		
	10%		0.0068		
	25%		0.0047		
	50%		0.0041		
3/8	Ar	RPM	10000		
	5%	IPT	0.0112		
	10%		0.0082		
	25%		0.0057		
	50%		0.0049		
Depth Of Cut = Aa		If Radial Engagement is > 15% of Tool Diameter, Please Use Max 1.5D			

- For entry, it is recommended to use slotting conditions.
- Adjust milling condition when unusual vibration or sound occurs.
- When using long reach tools, decrease width of cut and feed rate by 50%.
- For Finishing, please use 0.01D WOC, Max SFM shown on chart, and the IPT value for 50% stepover.

HIGH PERFORMANCE END MILLS

Standard Milling Conditions

ALH 3 Flute Series

List No. 9717, 9718, 9719, 9720, 9721, 9722, 9723, 9725

Slotting

Mill Diameter		Work Material		
		Aluminum Alloys 2024, 6061, 7075	Aluminum Cast	Copper Alloys, Brass, Bronze
		750-850 SFM	450-550 SFM	450-550 SFM
3	RPM	25900	16200	16200
	IPT	0.0014	0.0011	0.0011
1/8	RPM	24500	15300	15300
	IPT	0.0015	0.0011	0.0011
4	RPM	19400	12100	12100
	IPT	0.0019	0.0014	0.0014
3/16	RPM	16300	10200	10200
	IPT	0.0023	0.0017	0.0017
5	RPM	15500	9700	9700
	IPT	0.0024	0.0018	0.0018
6	RPM	12900	8100	8100
	IPT	0.0029	0.0021	0.0021
1/4	RPM	12200	7600	7600
	IPT	0.0030	0.0022	0.0022
5/16	RPM	9700	6100	6100
	IPT	0.0038	0.0028	0.0028
8	RPM	9700	6100	6100
	IPT	0.0038	0.0028	0.0028
3/8	RPM	8150	5100	5100
	IPT	0.0045	0.0033	0.0033
10	RPM	7750	4850	4850
	IPT	0.0047	0.0035	0.0035
7/16	RPM	7000	4350	4350
	IPT	0.0053	0.0039	0.0039
12	RPM	6500	4050	4050
	IPT	0.0057	0.0042	0.0042
1/2	RPM	6100	3800	3800
	IPT	0.0060	0.0044	0.0044
9/16	RPM	5400	3400	3400
	IPT	0.0068	0.0050	0.0050
5/8	RPM	4900	3050	3050
	IPT	0.0075	0.0055	0.0055
16	RPM	4900	3050	3050
	IPT	0.0076	0.0056	0.0056
3/4	RPM	4100	2550	2550
	IPT	0.0090	0.0066	0.0066
20	RPM	3900	2400	2400
	IPT	0.0095	0.0069	0.0069
Depth Of Cut = H		1D		

HIGH PERFORMANCE END MILLS

Standard Milling Conditions

Slotting

List No. 9717, 9718, 9719, 9720, 9721, 9722, 9723, 9725

Mill Diameter		Work Material				
		Aluminum Alloys 2024, 6061, 7075	Aluminum Cast	Copper Alloys, Brass, Bronze		
		750-850 SFM	450-550 SFM	450-550 SFM		
3	RPM	10000	10000	10000		
	IPT	0.0014	0.0011	0.0011		
1/8	RPM	10000	10000	10000		
	IPT	0.0015	0.0011	0.0011		
4	RPM	10000	10000	10000		
	IPT	0.0019	0.0014	0.0014		
3/16	RPM	10000	10000	10000		
	IPT	0.0023	0.0017	0.0017		
5	RPM	10000	1D			
	IPT	0.0024				
6	RPM	10000				
	IPT	0.0029				
1/4	RPM	10000				
	IPT	0.0030				
Depth Of Cut = H		1D				

- For entry, it is recommended to use slotting conditions.
- Adjust milling condition when unusual vibration or sound occurs.
- When using long reach tools, decrease width of cut and feed rate by 50%.
- For Finishing, please use 0.01D WOC, Max SFM shown on chart, and the IPT value for 50% stepover.

D: Dia. Of Mill

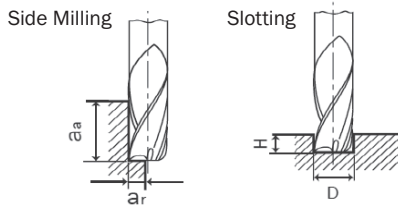

DLC Mill



List No. 6231HD Fractional sizes

EDP	Diameter of Mill	Shank Diameter	Length of Cut	Overall Length
1315363	1/8	3/8	3/8	2-5/16
1315370	3/16		7/16	
1315386	1/4		5/8	2-7/16
1315392	5/16		3/4	2-1/2
1315408	3/8			
1315414	7/16		1	2-11/16
1315420	1/2	1/2	1-1/4	3-1/4
1315437	5/8	5/8	1-5/8	3-3/4
1315443	3/4	3/4		4-1/8
1315450	1	1	2	4-1/2

1 per tube

WARNING: Cancer - www.P65Warnings.ca.gov

Standard Milling Conditions List No. 6231HD

Work Material	Aluminum		Aluminum Alloys					
	1070		4032, 6061		5052		7075	
	960 - 980 SFM		650 - 670 SFM		820 - 825 SFM		650 - 655 SFM	
Milling Conditions	RPM	Feed (IPM)	RPM	Feed (IPM)	RPM	Feed (IPM)	RPM	Feed (IPM)
Dia. of Mill (inch)								
1/8	30,000	31.5	19,900	14.9	25,100	22.6	19,900	11.9
3/16	20,000	38.0	13,300	17.5	16,800	26.5	13,300	14.0
1/4	15,000	39.4	10,000	17.5	12,600	26.5	9,940	13.9
5/16	12,000	39.4	8,000	21.5	10,030	32.0	7,950	16.9
3/8	10,000	45.0	6,700	22.6	8,360	33.9	6,630	17.9
7/16	8,500	47.2	5,700	23.9	7,160	37.6	5,680	19.9
1/2	7,500	47.2	5,000	25.0	6,270	37.6	4,970	19.9
5/8	6,000	47.2	4,000	25.0	5,020	37.7	3,980	19.9
3/4	5,000	47.2	3,400	25.5	4,180	37.6	3,320	19.9
1	3,700	47.2	2,500	25.0	3,140	37.7	2,490	19.9
Depth of Cut	a _a	1.5D						
	a _r	0.2D						
	H	1D						

HSS END MILLS

AG Mill Roughing



List No. 6485 Fractional Sizes

EDP	Diameter of Mill	Shank Diameter	Length of Cut	Number of Flutes	Overall Length		
1380710	1/4	3/8	5/8	4	2-7/16		
1380726	5/16		3/4		2-1/2		
1380732	3/8						
1380749	1/2		1-1/4		3-1/4		
1380755	5/8	5/8	1-5/8	5	3-3/4		
1380761	3/4	3/4			3-7/8		
1380778	7/8	7/8	1-7/8	6	4-1/8		
1380784	1	1	2		8	4-1/2	
1380790	1-1/4	1-1/4					
1380806	1-1/2						
1380812	2						

1 per tube

⚠ WARNING: Cancer - www.P65Warnings.ca.gov

Standard Milling Conditions List No. 6485

Work Material	Structural Steels Carbon Steels		Alloy Steels Pre-Hardened Steels		Mold Steels Stainless Steels		Nickel Alloys Titanium Alloys		Cast Irons		Aluminum Alloys Copper Alloys Nonferrous Alloys	
	120 - 130 SFM		90 - 100 SFM		70 - 80 SFM		60 - 65 SFM		145 - 150 SFM		280 - 285 SFM	
Milling Conditions												
Dia. Of Mill (inch)	RPM	Feed (IPM)	RPM	Feed (IPM)	RPM	Feed (IPM)	RPM	Feed (IPM)	RPM	Feed (IPM)	RPM	Feed (IPM)
-	2,000	10.2	1,500	7.1	1,200	3.9	1,000	3.0	2,400	12.6	4,500	47.2
1/4	1,900	10.4	1,400	7.3	1,100	4.0	950	3.1	2,200	12.6	4,300	48.3
5/16	1,500	11.0	1,200	7.5	1,000	4.6	720	3.1	1,800	13.3	3,400	51.3
-	1,500	11.0	1,200	7.5	1,000	4.7	720	3.1	1,800	13.4	3,400	51.2
3/8	1,300	11.0	1,000	7.6	760	4.6	630	3.2	1,500	13.5	2,900	51.7
-	1,200	11.0	900	7.5	720	4.7	590	3.1	1,400	13.4	2,700	51.2
-	1,000	11.0	800	7.5	600	4.7	490	3.3	1,200	13.4	2,300	51.2
1/2	950	11.0	720	7.6	570	4.7	470	3.3	1,100	13.5	2,200	51.7
-	800	11.0	610	7.5	480	4.7	400	3.3	950	13.4	1,800	51.2
5/8	760	11.0	570	7.5	460	4.7	380	3.3	900	13.5	1,700	51.3
3/4	630	11.0	480	7.5	380	4.5	320	3.3	750	13.5	1,400	50.8
-	600	11.0	450	7.1	360	4.3	290	3.1	720	13.4	1,400	51.2
7/8	540	11.8	410	8.6	330	5.3	270	3.6	640	16.3	1,200	59.2
-	480	11.4	360	7.9	290	5.1	250	3.4	550	15.4	1,100	55.1
1	470	11.4	360	7.9	290	5.0	240	3.2	560	15.7	1,100	54.4
-	400	10.2	300	7.1	240	4.3	200	3.1	470	14.2	900	51.2
1 1/4	380	11.4	290	7.7	230	4.8	190	3.5	450	15.2	860	55.6
1 1/2	320	8.0	240	4.7	190	3.4	160	2.6	370	10.1	720	38.8
-	300	6.7	250	4.3	180	2.9	150	2.0	360	9.1	670	33.1
-	240	4.3	180	2.8	140	1.8	120	1.3	290	5.9	550	20.5
2	240	5.3	180	3.7	140	2.5	120	1.7	280	7.2	540	25.9

Slotting

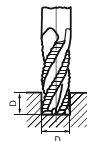

Side Milling

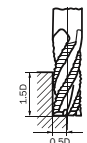

- 1) In dry milling which is recommended air blow, reduce the RPM and feed to 70% of above table values.
- 2) Adjust milling condition when unusual vibration or different sound occur.

AG Mill Heavy



List No. 6403 Fractional Sizes

EDP	Diameter of Mill	Shank Diameter	Length of Cut	Number of Flutes	Overall Length		
1380600	1/4	3/8	5/8	4	2-7/16		
1380617	5/16		3/4		2-1/2		
1380623	3/8						
1380630	1/2	1/2	1-1/4		3-1/4		
1380646	5/8	5/8	1-5/8		3-3/4		
1380652	3/4	3/4			3-7/8		
1380669	7/8	7/8	1-7/8		4-1/8		
1380675	1	1	2	6	4-1/2		
1380681	1-1/4	1-1/4					
1380698	1-1/2						
1380703	2						8

1 per tube

WARNING: Cancer - www.P65Warnings.ca.gov

Standard Milling Conditions List No. 6403

Work Material	Structural Steels Carbon Steels		Alloy Steels Pre-Hardened Steels		Mold Steels Stainless Steels		Nickel Alloys Titanium Alloys		Cast Irons		Aluminum Alloys Copper Alloys Nonferrous Alloys	
	150 - 155 SFM		115 - 125 SFM		95 - 105 SFM		75 - 80 SFM		175 - 185 SFM		330 - 350 SFM	
Milling Conditions												
Dia. Of Mill (inch)	RPM	Feed (IPM)	RPM	Feed (IPM)	RPM	Feed (IPM)	RPM	Feed (IPM)	RPM	Feed (IPM)	RPM	Feed (IPM)
-	5,000	11.4	3,800	7.5	3,200	5.1	2,500	3.5	5,800	30.3	10,800	52.0
-	3,000	11.4	2,300	7.5	1,900	5.1	1,600	3.5	3,500	30.3	6,500	52.0
-	2,500	11.4	1,900	7.5	1,600	5.1	1,300	3.5	2,900	31.1	5,400	52.0
1/4	2,300	11.2	1,800	7.7	1,500	5.2	1,200	3.3	2,800	31.1	5,200	53.0
5/16	1,900	11.5	1,400	7.6	1,200	5.1	1,000	3.5	2,200	31.0	4,100	52.2
-	1,900	11.4	1,400	7.5	1,200	5.1	1,000	3.5	2,200	31.1	4,100	52.0
3/8	1,600	11.5	1,200	7.7	1,000	4.9	790	3.3	1,800	31.6	3,500	53.0
-	1,500	11.8	1,200	7.9	1,000	5.1	800	3.5	1,700	31.5	3,200	52.0
-	1,300	11.4	1,000	7.9	800	5.1	600	3.5	1,400	31.1	2,800	52.0
1/2	1,200	11.2	920	7.7	760	5.3	600	3.6	1,400	31.6	2,600	51.9
-	1,000	11.4	800	7.9	600	5.1	500	3.5	1,200	31.1	2,200	52.0
5/8	940	11.2	730	7.7	610	5.3	480	3.5	1,100	30.0	2,100	52.0
3/4	780	10.5	610	7.7	510	4.7	400	3.1	920	28.9	1,700	52.0
-	750	10.2	600	7.9	500	4.7	400	3.1	900	29.1	1,700	52.0
7/8	670	9.4	520	7.0	440	4.0	340	2.6	790	26.1	1,500	46.7
-	600	8.7	500	5.9	400	3.5	300	2.4	700	22.8	1,300	38.6
1	580	10.5	460	6.3	380	4.1	300	2.7	690	26.8	1,300	46.0
-	500	7.9	400	4.7	300	3.1	250	2.0	600	20.1	1,100	33.9
1 1/4	470	7.4	370	4.4	310	3.2	240	2.5	550	16.9	1,000	29.6
1 1/2	390	7.0	310	4.1	260	3.2	200	2.1	460	10.3	870	18.7
-	370	6.7	300	4.3	220	2.9	180	2.0	450	9.1	800	15.5
-	300	4.3	240	2.8	160	1.8	120	1.3	320	5.9	620	10.5
2	290	5.1	230	3.3	150	2.2	120	1.5	310	7.3	610	13.7

- 1) In dry milling which is recommended air blow, reduce the RPM and feed to 70% of above table values.
- 2) Adjust milling condition when unusual vibration or different sound occur.

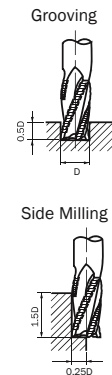

HSS END MILLS

Roughing and Finishing (Heavy Duty)



List No. 6367X Fractional sizes
SG Coated, 8% Cobalt HSS

EDP	Diameter of Mill	Shank Diameter	Length of Cut	Number of Flutes	Overall Length	
1175970	1/4	3/8	5/8	4	2-7/16	
1175986	5/16		3/4		2-1/2	
1175992	3/8		3/4		2-1/2	
1176007	1/2	1/2	1-1/4		3-1/4	
1176020	5/8	5/8	1-5/8		3-3/4	
1176059	3/4	3/4	1-5/8		3-7/8	
1176088	7/8	7/8	1-7/8	4-1/8		
1176100	1	3/4	2	6	4-1/2	
1176151	1	1	2		4-1/2	
1176168	1		4		6-1/2	
1176202	1-1/4	1-1/4	2		4-1/2	
1176219	1-1/4		4		6-1/2	
1176248	1-1/2		2		4-1/2	
1176254	1-1/2		4		6-1/2	
1176260	1-3/4		2		4-1/2	
1176283	2		2		4-1/2	8
1176122	2	2	4		7-3/4	

WARNING: Cancer - www.P65Warnings.ca.gov



List No. 6367 Fractional sizes
Surface Treat, 8% Cobalt HSS

EDP	Diameter of Mill	Shank Diameter	Length of Cut	Number of Flutes	Overall Length	
1024726	1/4	3/8	5/8	4	2-7/16	
1024732	5/16		3/4		2-1/2	
1024761	3/8		3/4		2-1/2	
1024812	1/2	1/2	1-1/4		3-1/4	
1024858	5/8	5/8	2		4	
1024864			1-5/8		3-3/4	
1024870	5/8	5/8	2-1/2	4-5/8		
1024921	3/4	3/4	1-5/8	6	3-3/4	
1024950			1-5/8		3-7/8	
1024915			3		5-1/4	
1024996	7/8	7/8	1-7/8		4-1/8	
1025000			1-7/8		4-1/8	
1024967	7/8	7/8	3-1/2		5-3/4	
1025067	1	3/4	2	8	4-1/2	
1025103		1	2		4-1/2	
1025023		1	4		6-1/2	
1025190	1-1/8	3/4	2		4-1/2	
1042873	1-1/4	3/4	2		6	4-1/2
1019565		1-1/4	4			6-1/2
1025212		1-1/4	2	4-1/2		
1025315	1-1/2	3/4	4	6-1/2		
1042880			2	4-1/2		
1019600			4	6-1/2		
1025350	1-3/4	1-1/4	2	4-1/2		
1025396			4	6-1/2		
1025401			2	4-1/2		
1025418	2	1-1/4	4	6-1/2		
1024282			2	4-1/2		
1025447			4	6-1/2		
1025620	2-1/2	2	4	8	7-3/4	
1025499			6		9-3/4	
1025591			8		11-3/4	
1086318	2-1/2	2	4		7-3/4	
1086324			6		9-3/4	
1086330			8		11-3/4	
1086347	3	2-1/2	10	13-3/4		
1086353			4	7-3/4		
1086360			6	9-3/4		
1086376	3	2-1/2	8	10	11-3/4	
1086382			10		13-3/4	
1086399			12		15-3/4	

1 per tube **WARNING:** Cancer - www.P65Warnings.ca.gov
Shanks 2" and Larger Have Combination Drive
8 And 10 Flutes Are Not Center Cutting

HSS-CO END MILLS

Standard Milling Conditions List No. 6367X

Work Material	Carbon Steels		Alloy Steels		Die Steels Stainless Steels		Nickel Alloys Titanium Alloys		Cast Iron		Aluminum Alloys Copper Alloys Nonferrous Alloys	
	118 SFM		83 SFM		70 SFM		60 SFM		130 SFM		260 SFM	
	RPM	Feed (IPM)	RPM	Feed (IPM)	RPM	Feed (IPM)	RPM	Feed (IPM)	RPM	Feed (IPM)	RPM	Feed (IPM)
1/4	1,800	9.4	1,300	6.8	1,100	4.8	890	2.8	2,000	24.0	4,000	48.0
3/8	1,200	8.6	840	5.4	680	3.5	600	2.4	1,400	22.4	2,700	43.2
1/2	880	8.4	630	5.8	510	3.7	450	2.7	1,000	22.4	2,000	46.4
5/8	710	8.5	510	5.7	410	3.4	360	2.6	800	22.4	1,600	44.8
3/4	590	8.0	420	5.2	340	3.3	300	2.4	670	21.4	1,400	41.4
1	440	8.4	320	6.0	260	3.6	230	2.8	500	24.0	1,000	45.0
1 1/4	360	5.8	260	4.1	210	2.5	180	1.9	400	16.3	800	29.8
1 1/2	300	4.7	210	3.2	170	1.9	150	1.5	340	13.5	700	25.2
1 3/4	260	3.4	180	2.2	150	1.4	130	1.1	290	11.3	600	18.0
Depth of Cut	a _s	1.5D										
	a _r	0.25D										
	H	0.5D										

Standard Milling Conditions List No. 6367

Work Material	Carbon Steels		Carbon Steels Alloy Steels		Die Steels Stainless Steels		Nickel Alloys Titanium Alloys		Cast Iron		Aluminum Alloys Copper Alloys Nonferrous Alloys	
	80 SFM		60 SFM		40 SFM		33 SFM		100 SFM		200 SFM	
	RPM	Feed (IPM)	RPM	Feed (IPM)	RPM	Feed (IPM)	RPM	Feed (IPM)	RPM	Feed (IPM)	RPM	Feed (IPM)
1/4	1,300	5.9	900	3.7	700	2.1	510	1.5	1,600	17.3	3,100	31.5
3/8	820	5.9	600	3.8	410	2.1	340	1.5	1,100	17.7	2,100	32.1
1/2	620	5.9	450	3.8	310	2.1	260	1.5	800	17.3	1,600	31.9
5/8	490	5.9	360	3.7	250	2.1	210	1.5	610	17.1	1,300	31.5
3/4	410	5.6	300	3.6	210	2.0	170	1.4	510	16.3	1,100	31.5
1	310	5.5	230	3.5	160	2.2	130	1.4	380	15.7	800	29.5
1 1/4	250	4.3	180	2.7	130	1.5	110	1.1	310	12.6	700	23.6
1 1/2	210	3.5	150	2.2	110	1.2	90	0.8	260	9.8	600	18.5
1 3/4	180	2.4	130	1.6	90	0.9	80	0.6	220	7.5	500	13.8
2	160	2.0	120	1.4	80	0.7	70	0.5	190	5.9	400	11.0
Depth of Cut	a _s	1.5D										
	a _r	0.25D										
	H	0.5D										

HSS END MILLS

Roughing (Hog)



List No. 6303 Bright Finish, 8% Cobalt HSS

EDP	Diameter of Mill	Shank Diameter	Length of Cut	Number of Flutes	Overall Length
1085363	1/4	3/8	5/8	4	2-7/16
1085370			1-1/4		3-1/16
1085386	5/16		3/4		2-1/2
1085392			1-3/8		3-1/8
1085408	3/8		3/4		2-1/2
1085414			1-1/2		3-1/4
1085420	1/2	1/2	1-1/4	3-1/4	
1085437			2	4	
1085443	5/8	5/8	1-5/8	3-3/4	
1085450			2-1/2	4-5/8	
1085466	3/4		1-5/8	3-7/8	
1085472			3	5-1/4	
1086267	3/4		1-5/8	3-7/8	
1086273			3	5-1/4	
1085489	7/8	7/8	1-7/8	4-1/8	
1085495			3-1/2	5-3/4	
1085500			1-7/8	4-1/8	
1085517			3-1/2	5-3/4	
1085523			3/4	2	4-1/4
1085530				1	3-1/4
1086003	1	1	2	4-1/2	
1086010			4	6-1/2	
1086026	3		5-1/2		
1086032	1-1/8		2	4-1/2	
1086049	3/4		2	4-1/2	
1086055			4	6-1/2	
1086061	1-1/4	1-1/4	2	4-1/2	
1086078			4	6-1/2	
1086084	3		5-1/2		
1086090	3/4		2	4-1/2	
1086106			4	6-1/2	
1086112	1-1/2		1-1/4	2	4-1/2
1086129		4		6-1/2	
1086135	3	5-1/2			
1086141	3/4	2		4-1/2	
1086158		4		6-1/2	
1086164	1-3/4	1-1/4		2	4-1/2
1086170			4	6-1/2	
1086187	3		5-1/2		
1086193	2		2	2	4-1/2
1086209				4	6-1/2
1086215	3			5-1/2	
1086221	2	4		7-3/4	
1086238		6		9-3/4	
1086244	2	8		11-3/4	
1086250		3	6-3/4		

1 per tube **WARNING:** Cancer - www.P65Warnings.ca.gov
 Shanks 2" And Larger Have Combination Drive
 All Sizes Are Not Center Cutting

List No. 6303X SG Coated, 8% Cobalt HSS

EDP	Diameter of Mill	Shank Diameter	Length of Cut	Number of Flutes	Overall Length	
1175510	1/4	3/8	5/8	4	2-7/16	
1175533	5/16		3/4		2-1/2	
1175556	3/8		3/4		2-1/2	
1175579	1/2	1/2	1-1/4		3-1/4	
1175585			2		4	
1175591	5/8	5/8	1-5/8		3-3/4	
1175607			2-1/2	4-5/8		
1175636	3/4		3/4	1-5/8	3-7/8	
1175642				3	5-1/4	
1175659	7/8			7/8	1-7/8	4-1/8
1175671					7/8	4-1/8
1175694	1	1			3/4	4-1/4
1175716					2	4-1/2
1175722	1		4		6-1/2	
1175739			3		5-1/2	
1175774	1-1/4		1-1/4	2	4-1/2	
1175780				4	6-1/2	
1175797		3		5-1/2		
1175825		1-1/2		1-1/4	2	4-1/2
1175831					4	6-1/2
1175848		1-3/4			3	5-1/2
1175877	2		4-1/2			
1175883	1-3/4	2	4		6-1/2	
1175890			3		5-1/2	
1175905	2		2	2	4-1/2	
1175934				4	7-3/4	
1175940	2			6	9-3/4	
1175963				3	6-3/4	

WARNING: Cancer - www.P65Warnings.ca.gov

Roughing (Hog)



List No. 6307 8% Cobalt HSS

EDP	Diameter of Mill	Shank Diameter	Length of Cut	Number of Flutes	Overall Length	
1182749	1/4	3/8	5/8	3	2-7/16	
1182755			1-1/4		3-1/16	
1182761	5/16		3/4		2-1/2	
1182778			1-3/8		3-1/8	
1182784	3/8		3/4		2-1/2	
1182790			1-1/2		3-1/4	
1182806			1-1/4		3-1/4	
1182812	1/2		1/2		2	4
1182829	5/8		5/8		1-5/8	4
1182835		2-1/2		4-5/8		
1182841	3/4	1-5/8		3-7/8		
1182864	3/4	3/4	1-5/8	5	3-7/8	
1182887			1-7/8		4-1/8	
1182909	7/8	7/8	1-7/8	4-1/8		
1182921	1	3/4	2	5	4-1/4	
1182944		1	2		4-1/2	
1182950			4		6-1/2	
1182967			3		5-1/2	
1182973			1-1/8		2	4-1/2
1183000	1-1/4	1-1/4	2	6	4-1/2	
1183017			4		6-1/2	
1183023			3		5-1/2	
1183052	1-1/2		2		4-1/2	
1183069			4		6-1/2	
1183075			3		5-1/2	
1183103	1-3/4		2		4-1/2	
1183132	2		2		2	4-1/2
1183149					4	6-1/2
1183161		2		4	7-3/4	
1183178				6	9-3/4	

1 per tube
Shanks 2" And Larger Have Combination Drive

! WARNING: Cancer - www.P65Warnings.ca.gov

HSS-CO END MILLS

Standard Milling Conditions List No. 6303, 6307

Work Material	Carbon Steels		Alloy Steels		Die Steels Stainless Steels		Nickel Alloys Titanium Alloys		Cast Iron		Aluminum Alloys Copper Alloys Nonferrous Alloys	
	80 SFM		60 SFM		40 SFM		33 SFM		100 SFM		200 SFM	
	RPM	Feed (IPM)	RPM	Feed (IPM)	RPM	Feed (IPM)	RPM	Feed (IPM)	RPM	Feed (IPM)	RPM	Feed (IPM)
1/4	1,300	5.1	900	3.1	700	1.7	510	1.2	1,600	6.7	3,100	26.4
3/8	820	5.1	600	3.1	410	1.7	340	1.2	1,100	6.7	2,100	26.4
1/2	620	5.1	450	3.2	310	1.7	260	1.2	800	6.7	1,600	26.4
5/8	490	5.1	360	3.1	250	1.7	210	1.2	610	6.7	1,300	26.4
3/4	410	5.1	300	3.0	210	1.7	170	1.2	510	6.7	1,100	26.4
1	310	5.1	230	3.1	160	1.8	130	1.2	380	6.7	800	26.4
1 1/4	250	4.9	180	3.1	130	1.8	110	1.2	310	6.7	700	26.4
1 1/2	210	3.5	150	2.3	110	1.3	90	0.9	260	5.3	600	21.7
1 3/4	180	2.6	130	1.6	90	0.9	80	0.6	220	3.7	500	15.7
2	160	2.4	120	1.6	80	0.9	70	0.6	190	3.5	400	14.2
Depth of Cut	a _a	1.5D										
	a _r	0.25D										
	H	0.5D										

1) The above cutting speeds and feeds apply to regular end mill flute length.
For long fluted end mills please use the following factors below:

Cutting Length	Reduce Feed by
2.5 × Diameter	15%
3 × Diameter	25%
4 × Diameter	55%

2) In dry milling, reduce the RPM and Feed 30% of values on table above. (recommended air blow)
3) Adjust drilling condition when unusual vibration or sound occurs.

D: Dia. of Mill

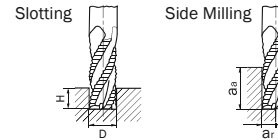

Standard Milling Conditions List No. 6303X

Work Material	Carbon Steels		Alloy Steels		Die Steels Stainless Steels		Nickel Alloys Titanium Alloys		Cast Iron		Aluminum Alloys Copper Alloys Nonferrous Alloys	
	118 SFM		83 SFM		70 SFM		60 SFM		130 SFM		260 SFM	
	RPM	Feed (IPM)	RPM	Feed (IPM)	RPM	Feed (IPM)	RPM	Feed (IPM)	RPM	Feed (IPM)	RPM	Feed (IPM)
1/4	1,800	7.2	1,300	4.7	1,100	3.5	890	2.1	2,000	9.6	4,000	36.8
3/8	1,200	7.2	840	5.0	680	2.7	600	1.9	1,400	9.0	2,700	33.5
1/2	880	7.0	630	4.8	510	2.9	450	2.0	1,000	8.8	2,000	36.0
5/8	710	7.1	510	4.5	410	3.0	360	2.1	800	8.6	1,600	35.2
3/4	590	6.8	420	4.4	340	2.7	300	2.0	670	8.6	1,400	34.7
1	440	7.8	320	5.0	260	3.4	230	2.5	500	11.3	1,000	42.5
1 1/4	360	7.6	260	5.0	210	3.3	180	2.3	400	11.0	800	40.8
1 1/2	300	5.2	210	3.2	170	2.0	150	1.5	340	7.3	700	28.6
1 3/4	260	3.6	180	2.2	150	1.4	130	1.1	290	4.9	600	19.8
—	1,900	7.1	1,300	4.3	1,100	2.8	930	2.1	2,100	8.7	4,200	35.0
Depth of Cut	a _a	1.5D										
	a _r	0.25D										
	H	0.5D										

1) In dry milling, reduce the RPM and feed rate 30% of values on table above. (recommended air blow)
2) Adjust milling condition when unusual vibration or sound occurs.

D: Dia. of Mill

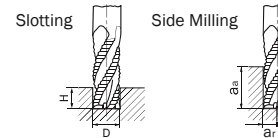

Two Flute Single End



List No. 6231 8% Cobalt HSS

EDP	Diameter of Mill	Shank Diameter	Length of Cut	Overall Length																							
1030592	1/8	3/8	3/8	2-5/16																							
1230784	5/32		3/8		7/16																						
1030614	3/16					3/8	7/16																				
1230790	7/32							3/8	7/16																		
1030637	1/4									3/8	7/16																
1230806	9/32											3/8	7/16														
1030672	5/16													3/8	7/16												
1230812	11/32															3/8	7/16										
1030775	3/8																	3/8	7/16								
1230829	13/32																			3/8	7/16						
1030781	7/16																					3/8	7/16				
1230835	15/32																							3/8	7/16		
1030803	1/2																									3/8	7/16
1230841	17/32																										
1230858	9/16	3/8		7/16																							
1030810	5/8		3/8		7/16																						
1030855	11/16					3/8	7/16																				
1230864	13/16							3/8	7/16																		
1030941	15/16									3/8	7/16																
1230870	1											3/8	7/16														
1030958	1 1/8													3/8	7/16												
1230887	1 1/4															3/8	7/16										
1030964	1 1/2																	3/8	7/16								
1226927	1 3/8																			3/8	7/16						
1031066	1 1/2																					3/8	7/16				
1230893	1 5/8																							3/8	7/16		
1031117	1 3/4																									3/8	7/16
1230909	1 7/8																										
1031130	2	3/8		7/16																							
1031146	2 1/8		3/8		7/16																						
1230915	2 1/4					3/8	7/16																				
1230703	2 3/8							3/8	7/16																		
1031169	2 1/2									3/8	7/16																
1230710	2 5/8											3/8	7/16														
1230726	2 7/8													3/8	7/16												
1031198	3															3/8	7/16										
1230732	3 1/8																	3/8	7/16								
1230749	3 1/4																			3/8	7/16						
1031203	3 1/2																					3/8	7/16				
1031226	3 3/4																							3/8	7/16		
1230755	3 5/8																									3/8	7/16
1031261	3 7/8																										
1230761	4	3/8		7/16																							
1031290	4 1/8		3/8		7/16																						
1031341	4 1/4					3/8	7/16																				
1031393	4 1/2							3/8	7/16																		

1 per tube **WARNING:** Cancer - www.P65Warnings.ca.gov
Shanks 2" and Larger Have Combination Drive

List No. 6231X SG Coated, 8% Cobalt HSS

EDP	Diameter of Mill	Shank Diameter	Length of Cut	Overall Length																					
1176290	1/8	3/8	3/8	2-5/16																					
1176311	5/32		3/8		7/16																				
1176334	3/16				3/8	1/2																			
1176357	1/4					3/8	9/16																		
1176370	5/16						3/8	13/16																	
1176392	3/8							3/8	2-1/2																
1176414	7/16								3/8	3															
1176443	1/2									3/8	3-1/8														
1176450	9/16										3/8	3-7/16													
1176472	5/8												3/8	3-9/16											
1176495	11/16														3/8	3-9/16									
1176517	1																3/8	3-9/16							
1176530	3/4																		3/8	3-9/16					
1176546	7/8																				3/8	3-9/16			
1176569	1	3/8		3-9/16																					
1176575	1 1/8		3/8																				3-9/16		
1176603	1 1/4				3/8																			3-9/16	
1176661	1 1/2					3/8																			3-9/16
1176712	1 3/4						3/8																		

WARNING: Cancer - www.P65Warnings.ca.gov

Two Flute Long Single End



List No. 6230 8% Cobalt HSS

EDP	Diameter of Mill	Shank Diameter	Length of Cut	Overall Length
0107454	1.0	6.0	2.0	50.0
0107505	1.5		3.0	
0107528	2.0		7.0	
0107540	2.5		9.0	
0107730	3.0	8.0	12.0	60.0
0107769	3.5		15.0	
0107810	4.0			
0107855	4.5		10.0	
0107878	5.0			
0107935	5.5			
0107941	6.0			
0107970	6.5	10.0	25.0	75.0
0108066	7.0			
0108072	7.5			
0108089	8.0			
0108095	8.5	12.0	30.0	80.0
0108100	9.0			
0108117	9.5			
0108123	10.0			
0108249	12.0	16.0	35.0	90.0
0108278	13.0			
0108358	14.0			
0108387	15.0			
0108444	16.0	20.0	40.0	105.0
0108530	17.0			
0108576	19.0			
0108640	20.0			
0108977	24.0	25.0	50.0	120.0
0109004	25.0			
0109027	26.0			
0109457	30.0			

⚠ WARNING: Cancer - www.P65Warnings.ca.gov

Regular Single End



List No. 6233 8% Cobalt HSS

EDP	Diameter of Mill	Shank Diameter	Length of Cut	Overall Length
1043479	1/4	3/8	1	3 1/16
1043485	5/16		1 1/4	3 5/16
1043491	3/8		1 1/2	3 1/4
1043507			1	2 3/4
1043513	1/2	1/2	2	4
1043520			1 1/2	3 1/2
1043536			3	5
1043542			5/8	2
1043571	3/4	3/4	2 1/4	4 1/2
1043600	7/8	7/8	2 1/2	4 3/4
1043639	1	1	3	5 1/2
1043674	1 1/8			
1043680	1 1/4			
1043702	1 1/2			
1043725	1 3/4	1 1/4	3	5 1/2
1043760	2			

1 per tube

⚠ WARNING: Cancer - www.P65Warnings.ca.gov

Standard Milling Conditions List No. 6231, 6233, 6230

Work Material		Carbon Steels		Alloy Steels		Die Steels Stainless Steels		Nickel Alloys Titanium Alloys		Cast Iron		Aluminum Alloys Copper Alloys Nonferrous Alloys	
		85 SFM		60 SFM		40 SFM		33 SFM		100 SFM		200 SFM	
Milling Conditions	Dia. of Mill (inch) (mm)	RPM	Feed (IPM)	RPM	Feed (IPM)	RPM	Feed (IPM)	RPM	Feed (IPM)	RPM	Feed (IPM)	RPM	Feed (IPM)
		—	2	4,000	3.1	2,800	2.0	2,000	1.1	1,600	0.7	4,800	9.1
—	3	2,700	3.3	1,900	2.1	1,300	1.2	1,100	0.8	3,200	9.4	6,400	17.7
1/8	3.175	2,600	3.3	1,800	2.1	1,300	1.2	1,100	0.8	3,100	9.4	6,100	17.7
3/16	4.7625	1,700	3.3	1,200	2.1	840	1.2	680	0.8	2,100	9.4	4,100	17.7
—	5	1,600	3.3	1,100	2.1	800	1.2	640	0.8	1,900	9.4	3,800	17.7
—	6	1,300	3.3	930	2.1	660	1.2	530	0.8	1,600	9.4	3,200	17.7
1/4	6.35	1,300	3.3	890	2.1	630	1.2	510	0.8	1,600	9.4	3,100	17.7
—	8	1,000	3.3	700	2.1	500	1.2	400	0.8	1,200	9.4	2,400	17.7
3/8	9.525	850	3.3	600	2.1	420	1.2	340	0.8	1,100	9.4	2,100	17.7
—	10	800	3.4	560	2.1	400	1.2	320	0.8	960	9.4	1,900	17.7
—	12	660	3.3	460	2.1	330	1.2	270	0.8	800	9.4	1,600	17.7
1/2	12.7	640	3.3	450	2.1	320	1.2	260	0.8	800	9.4	1,600	17.7
—	15	530	3.3	370	2.1	270	1.2	210	0.8	640	9.4	1,300	17.7
5/8	15.875	510	3.3	360	2.1	260	1.2	210	0.8	610	9.4	1,300	17.7
3/4	19.05	430	3.2	300	2.0	210	1.1	170	0.7	510	9.1	1,100	16.9
—	20	400	3.1	280	2.0	200	1.1	160	0.7	480	9.1	960	16.5
—	25	320	2.4	220	1.5	160	0.8	130	0.6	380	7.1	760	12.6
1	25.4	320	2.4	230	1.5	160	0.8	130	0.6	380	7.0	770	12.4
—	30	270	1.9	190	1.2	130	0.7	110	0.5	320	5.5	640	10.2
1 1/4	—	260	1.8	180	1.1	130	0.6	110	0.5	310	5.1	610	9.8
1 1/2	—	220	1.5	150	0.9	110	0.5	90	0.4	260	4.1	510	7.9
—	—	200	1.3	140	0.8	100	0.5	80	0.3	240	3.8	480	7.1
1 3/4	—	190	1.1	130	0.6	90	0.4	80	0.3	220	3.0	440	5.9
—	—	160	0.7	110	0.4	80	0.2	60	0.2	190	2.0	380	3.5
2	—	160	0.6	120	0.4	80	0.2	70	0.2	190	1.9	390	3.4
Depth of Cut		a _a	1.5D										
		a _r	0.25D										
		H	0.5D										

1) The above cutting speeds and feeds apply to regular end mill flute length.
For long fluted end mills please use the following factors below:

Cutting Length	Reduce Feed by
2.5 × Diameter	15%
3 × Diameter	25%
4 × Diameter	55%
5 × Diameter	65%
6 × Diameter	75%

D: Dia. of Mill

Side Milling

Slotting

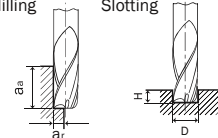

2) In dry milling, reduce the RPM and Feed 30% of values on table above. (recommended air blow)
3) Adjust drilling condition when unusual vibration or different sound occurs.

Standard Milling Conditions List No. 6231X

Work Material		Carbon Steels		Alloy Steels		Die Steels Stainless Steels		Nickel Alloys Titanium Alloys		Cast Iron		Aluminum Alloys Copper Alloys Nonferrous Alloys	
		118 SFM		83 SFM		70 SFM		60 SFM		130 SFM		260 SFM	
Milling Conditions	Dia. of Mill (inch)	RPM	Feed (IPM)	RPM	Feed (IPM)	RPM	Feed (IPM)	RPM	Feed (IPM)	RPM	Feed (IPM)	RPM	Feed (IPM)
		1/8	3,600	5.5	2,600	3.5	2,100	2.2	1,800	1.7	4,000	15.2	8,000
3/16	2,400	5.5	1,700	3.5	1,400	2.2	1,200	1.6	2,700	15.1	5,300	28.0	
1/4	1,800	5.5	1,300	3.5	1,100	2.2	890	1.7	2,000	15.4	4,000	28.0	
3/8	1,200	5.5	840	3.6	680	2.2	600	1.7	1,400	15.7	2,700	28.3	
1/2	880	5.5	630	3.6	510	2.2	450	1.7	1,000	15.4	2,000	28.3	
5/8	710	5.5	510	3.5	410	2.2	360	1.7	800	15.3	1,600	28.0	
3/4	590	5.5	420	3.5	340	2.1	300	1.6	670	14.8	1,400	27.2	
1	440	3.9	320	2.6	260	1.6	230	1.2	500	11.0	1,000	20.5	
1 1/4	360	3.0	260	2.0	210	1.3	180	0.9	400	8.3	800	15.0	
1 1/2	300	2.6	210	1.6	170	1.0	150	0.8	340	6.7	700	12.6	
Depth of Cut		a _a	1.5D										
		a _r	0.25D										
		H	0.5D										

Four Flute Single End



List No. 6210 8% Cobalt HSS (Unit) : mm

EDP	Diameter of Mill	Shank Diameter	Length of Cut	Overall Length	
0110773	2.5	6.0	7.0	50.0	
0110824	3.0		9.0		
0111282	3.5	8.0	12.0	60.0	
0111327	4.0		15.0		
0111459	4.5				
0111516	5.0				
0111619	5.5				
0111660	6.0	10.0	20.0	65.0	
0111866	6.5				
0112060	7.0				
0112564	7.5		25.0		75.0
0112667	8.0				
0112680	8.5				
0112696	9.0				
0112701	9.5	12.0	30.0	80.0	
0112782	10.0				
0112810	11.0	16.0	35.0	90.0	
0112879	12.0				
0112891	13.0				
0113067	14.0	20.0	40.0	95.0	
0113118	15.0				
0113227	16.0	25.0	50.0	105.0	
0113233	17.0				
0113262	18.0				
0113320	19.0				
0113336	20.0	25.0	55.0	110.0	
0113497	24.0				
0113577	26.0				
0113611	28.0	25.0	55.0	120.0	
0113772	30.0				

1 per tube

⚠ WARNING: Cancer - www.P65Warnings.ca.gov

Multi-Flute Single End Center Cutting



List No. 6211M 8% Cobalt HSS

EDP	Diameter of Mill	Shank Diameter	Length of Cut	Number of Flutes	Overall Length
1030345	1/8	3/8	3/8	4	2-5/16
1042290	3/16		1/2		2-3/8
1042305	1/4		5/8		2-7/16
1042311	5/16		3/4		2-1/2
1042328	3/8		3/4		2-1/2
1042334	1/2	1/2	1-1/4	6	3-1/4
1030351					
1042340	5/8	5/8	1-5/8	4	3-3/4
1030368					
1042357	3/4	3/4	1-5/8	4	3-7/8
1030374					
1042363	7/8	7/8	1-7/8	4	4-1/8
1030380					
1042370	1	1	2	4	4-1/2
1030402				6	
1042386				4	
1030419				6	
1042392				4	
1030425	1-1/4	1-1/4	2	6	
1042408				4	
1030586				6	
1042414	2	1-1/4	4	6	6-1/2
1042850					

⚠ WARNING: Cancer - www.P65Warnings.ca.gov



List No. 6211X 8% Cobalt HSS, SG Coated

EDP	Diameter of Mill	Shank Diameter	Length of Cut	Number of Flutes	Overall Length
1176729	1/8	3/8	3/8	4	2-5/16
1176735	3/16		1/2		2-3/8
1176741	1/4		5/8		2-7/16
1176758	5/16		3/4		2-1/2
1176764	3/8		3/4		2-1/2
1176770	1/2	1/2	1-1/4	6	3-1/4
1176787					
1176793	5/8	5/8	1-5/8	4	3-3/4
1176809					
1176815	3/4	3/4	1-5/8	4	3-7/8
1176821					

1 per tube

EDP	Diameter of Mill	Shank Diameter	Length of Cut	Number of Flutes	Overall Length
1176838	7/8	7/8	1-7/8	4	4-1/8
1176844				6	
1176850	1	1	2	4	4-1/2
1176867				6	
1176873				4	
1176880	1-1/8	1-1/4	2	6	4-1/2
1176896				4	
1176901	1-1/4	1-1/4	2	6	4-1/2
1176918				4	
1176924				6	

⚠ WARNING: Cancer - www.P65Warnings.ca.gov

HSS END MILLS

Multi-Flute Long Single End Center Cutting



List No. 6213 8% Cobalt HSS

EDP	Diameter of Mill	Shank Diameter	Length of Cut	Number of Flutes	Overall Length
1042741	1/4	3/8	1 1/4	4	3 1/16
1042758	5/16		1 3/8		3 1/8
1042764	3/8		1 1/2		3 1/4
1042770	1/2	1/2	2		4
1042787	5/8	5/8	2 1/2		4 5/8
1042793	3/4	3/4	3		5 1/4
1042809	7/8	7/8	3 1/2		5 3/4
1042815	1	1	4		6 1/2
1042821	1 1/4	1 1/4			

1 per tube

WARNING: Cancer - www.P65Warnings.ca.gov

Standard Milling Conditions

List No. 6210, 6211M, 6213

4 Flute

Work Material		Carbon Steels		Alloy Steels		Die Steels Stainless Steels		Nickel Alloys Titanium Alloys		Cast Iron		Aluminum Alloys Copper Alloys Nonferrous Alloys	
Milling Conditions		85 SFM		60 SFM		40 SFM		33 SFM		100 SFM		200 SFM	
Dia. of Mill (inch)	(mm)	RPM	Feed (IPM)	RPM	Feed (IPM)	RPM	Feed (IPM)	RPM	Feed (IPM)	RPM	Feed (IPM)	RPM	Feed (IPM)
		—	3	2,700	5.1	1,900	3.1	1,300	1.8	1,100	1.2	3,200	14.2
1/8	3.175	2,600	5.1	1,800	3.1	1,300	1.8	1,100	1.2	3,100	14.2	6,100	26.4
3/16	4.7625	1,700	5.1	1,200	3.1	840	1.7	680	1.2	2,100	14.2	4,100	26.4
—	5	1,600	5.1	1,100	3.1	800	1.7	640	1.2	1,900	14.2	3,800	25.6
—	6	1,300	5.1	930	3.1	660	1.7	530	1.2	1,600	14.2	3,200	26.4
1/4	6.35	1,300	5.1	890	3.1	630	1.7	510	1.2	1,600	14.2	3,100	26.4
—	8	1,000	5.1	700	3.1	500	1.7	400	1.2	1,200	14.2	2,400	26.4
3/8	9.525	850	5.1	600	3.1	420	1.8	340	1.2	1,100	14.4	2,100	26.6
—	10	800	5.1	560	3.2	400	1.8	320	1.2	960	14.6	1,900	26.8
—	12	660	5.1	460	3.2	330	1.8	270	1.2	800	14.6	1,600	26.4
1/2	12.7	640	5.1	450	3.2	320	1.8	260	1.2	800	14.6	1,600	26.4
—	15	530	5.1	370	3.1	270	1.8	210	1.2	640	14.6	1,300	26.4
5/8	15.875	510	5.1	360	3.1	260	1.7	210	1.2	610	14.4	1,300	25.6
3/4	19.05	430	4.9	300	3.0	210	1.7	170	1.1	510	13.6	1,100	25.2
—	20	400	4.7	280	3.0	200	1.7	160	1.1	480	13.4	960	24.8
—	25	320	3.6	220	2.3	160	1.3	130	0.9	380	10.2	760	18.9
1	25.4	320	3.5	230	2.3	160	1.3	130	0.9	380	10.0	770	18.7
—	30	270	2.9	190	1.8	130	1.0	110	0.7	320	8.3	640	15.4
1 1/4	31.75	260	2.7	180	1.7	130	1.0	110	0.7	310	7.9	610	14.2
1 1/2	38.1	220	2.2	150	1.4	110	0.8	90	0.5	260	6.1	510	11.4
—	40	200	2.0	140	1.3	100	0.7	80	0.5	240	5.5	480	10.6
1 3/4	44.45	190	1.6	130	1.0	90	0.6	80	0.4	220	4.1	440	8.7
—	50	160	1.0	110	0.6	80	0.4	60	0.2	190	2.9	380	5.5
2	50.8	160	1.0	120	0.6	80	0.3	70	0.2	190	2.8	390	5.3
Depth of Cut	a _a	1.5D											
	a _r	0.25D											

Standard Milling Conditions

List No. 6210, 6211M, 6213

6 Flute

Work Material		Carbon Steels		Alloy Steels		Die Steels Stainless Steels		Nickel Alloys Titanium Alloys		Cast Iron		Aluminum Alloys Copper Alloys Nonferrous Alloys	
Milling Conditions		85 SFM		60 SFM		40 SFM		33 SFM		100 SFM		200 SFM	
Dia. of Mill (inch)		RPM	Feed (IPM)	RPM	Feed (IPM)	RPM	Feed (IPM)	RPM	Feed (IPM)	RPM	Feed (IPM)	RPM	Feed (IPM)
		1/2		640	7.7	450	4.8	320	2.7	260	1.8	800	21.9
5/8		510	7.7	360	4.6	260	2.6	210	1.8	610	21.6	1,300	38.4
3/4		430	7.4	300	4.5	210	2.5	170	1.7	510	20.4	1,100	37.8
7/8		370	6.5	260	4.0	180	2.2	150	1.5	440	17.7	900	33.1
1		320	5.3	230	3.4	160	1.9	130	1.3	380	15.1	770	28.1
1 1/4		260	4.1	180	2.6	130	1.5	110	1.0	310	11.8	610	21.3
1 1/2		220	3.2	150	2.1	110	1.2	90	0.8	260	9.2	510	17.1
2		160	1.5	120	0.9	80	0.5	70	0.3	190	4.1	390	8.0
Depth of Cut	a _a	1.5D											
	a _r	0.25D											

1) The above cutting speeds and feeds apply to regular end mill flute length.
For long fluted end mills please use the following factors below:

Cutting Length	Reduce Feed by
2.5 × Diameter	15%
3 × Diameter	25%
4 × Diameter	55%
5 × Diameter	65%
6 × Diameter	75%

D: Dia. of Mill

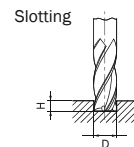

Side Milling

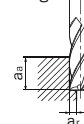

2) In dry milling, reduce the RPM and Feed 30% of values on table above. (recommended air blow)

3) Adjust drilling condition when unusual vibration or different sound occurs.

Standard Milling Conditions List No. 6211X

4 Flute

Work Material	Carbon Steels		Alloy Steels		Die Steels Stainless Steels		Nickel Alloys Titanium Alloys		Cast Iron		Aluminum Alloys Copper Alloys Nonferrous Alloys	
	118 SFM		83 SFM		70 SFM		60 SFM		130 SFM		260 SFM	
	RPM	Feed (IPM)	RPM	Feed (IPM)	RPM	Feed (IPM)	RPM	Feed (IPM)	RPM	Feed (IPM)	RPM	Feed (IPM)
1/8	3,600	8.6	2,600	5.2	2,100	2.5	1,800	2.5	4,000	20.8	8,000	38.4
3/16	2,400	6.7	1,700	4.1	1,400	2.2	1,200	1.9	2,700	17.3	5,300	31.8
1/4	1,800	7.9	1,300	4.7	1,100	3.1	900	2.5	2,000	22.4	4,000	36.8
3/8	1,200	6.7	900	4.7	700	2.8	600	2.0	1,400	19.6	2,700	33.5
1/2	880	7.4	630	4.8	510	3.1	450	2.3	1,000	20.0	1,990	37.4
5/8	710	7.4	510	4.5	410	3.0	360	2.2	800	20.8	1,590	34.3
3/4	590	6.6	420	4.4	340	2.7	300	2.0	670	18.5	1,330	31.9
1	440	4.8	320	3.1	260	2.0	230	1.5	500	13.4	1,000	24.8
1 1/4	360	3.8	260	2.5	210	1.6	180	1.2	400	10.2	800	18.9
1 1/2	300	3.1	210	1.9	170	1.2	150	0.9	340	8.2	670	15.0
Depth of Cut	a _a	1.5D										
	a _r	0.25D										

6 Flute

Work Material	Carbon Steels		Alloy Steels		Die Steels Stainless Steels		Nickel Alloys Titanium Alloys		Cast Iron		Aluminum Alloys Copper Alloys Nonferrous Alloys	
	116 SFM		83 SFM		70 SFM		60 SFM		130 SFM		330 SFM	
	RPM	Feed (IPM)	RPM	Feed (IPM)	RPM	Feed (IPM)	RPM	Feed (IPM)	RPM	Feed (IPM)	RPM	Feed (IPM)
1/2	880	11.1	630	7.2	510	4.6	450	3.4	1,000	30.0	2,700	56.1
5/8	710	11.1	510	6.7	410	4.4	360	3.2	800	31.2	1,990	51.5
3/4	590	9.9	420	6.6	340	4.1	300	3.1	670	27.7	1,590	47.9
1	440	7.3	320	4.7	260	3.0	230	2.3	500	20.1	1,330	37.2
1 1/4	360	5.7	260	3.7	210	2.3	180	1.7	400	15.4	1,000	28.3
1 1/2	300	4.6	210	2.9	170	1.8	150	1.4	340	12.2	800	22.5
Depth of Cut	a _a	1.5D										
	a _r	0.25D										

1) The above cutting speeds and feeds apply to regular end mill flute length.
For long fluted end mills please use the following factors below:

Cutting Length	Reduce Feed by
2.5 × Diameter	15%
3 × Diameter	25%
4 × Diameter	55%

2) In dry milling, reduce the RPM and Feed 30% of values on table above. (recommended air blow)
3) Adjust drilling condition when unusual vibration or different sound occurs.

D: Dia. of Mill

Side Milling

Slotting

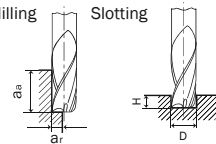

Shaping Up Your Chips

Chip Load vs. Chip Thickness

Chip shape plays an important role in proper performance, chip evacuation, and heat management while milling. A thick-to-thin chip shape is ideal. This is created when radial width of cut is 50% or less. This is a part of the reason slotting can be so hard on cutters.

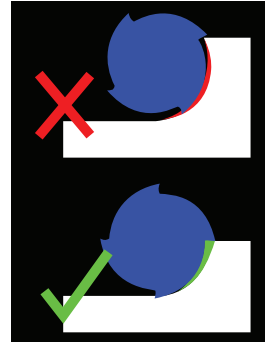

Chip load and chip thickness are commonly mistaken as being one and the same. This stems from traditional toolpaths engaging half of cutter diameter. As a round tool comes around to shear a chip, width of cut plays an important role in how thick that chip will be.

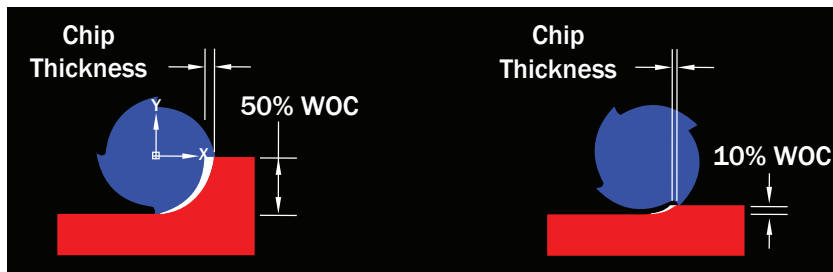

Now comes the fun part- compensating for chip thinning allows for increased feed rates. As radial width of cut decreases, feed rate increases to maintain the same chip thickness. Use the formula below to find your ideal cutting condition.

$$\text{Adjusted Feed Rate} = \frac{\text{IPT} \times D}{2 \times \sqrt{(D \times \text{RDOC}) - \text{RDOC}}}$$

IPT = IPT @ 50% RDOC
 D = Cutter Diameter
 RDOC = Radial Depth of Cut

Ball Nose End Mill

Ball nose end mills are commonly used for finishing contoured surfaces. Being a full radius end, depth of cut determines effective cutting diameter. Calculating the effective cutting diameter is necessary to determine proper feed and speed adjustments.

$$\text{Effective Cutting Diameter} = 2 \times \sqrt{\text{ADOC} \times (D - \text{ADOC})}$$

Radial stepover is a major variable in determining surface finish. This will create a “scallop height”.



High Speed Machining
High Performance Tooling

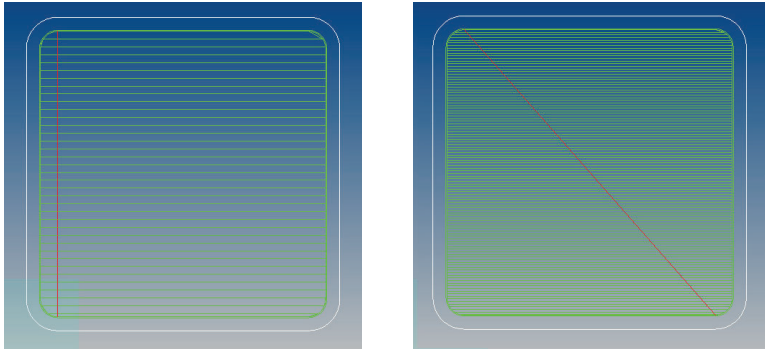

Machining 300 Series Stainless Steel

Traditional Strategy

½” 4 Flute End Mill
 290 SFM
 0.0027 IPT
 0.5XD Axial DOC
 0.3XD Radial WOC
 30 Minute Cycle

HSM Strategy

½” 4 Flute End Mill
 720 SFM
 0.0046 IPT
 1.5XD Axial DOC
 0.1XD Radial WOC
 18 Minute Cycle

High Speed Machining is a strategy used to decrease cycle time and increase tool life. HSM uses light radial width of cut and heavy axial depth of cut to remove a lot of material quickly. The light radial width of cut allows for faster feed rates. Using as much of the full LOC of the end mill promotes better work distribution through the flutes and leads to increased tool life. Along with increased feed rates, increased surface speed is also desirable with HSM. Because the tool is engaging less material, less heat is generated. SFM can be increased to achieve even faster cycle time.

END MILL TECHNICAL

High Efficiency Machining
HSM Meets Modern CAM

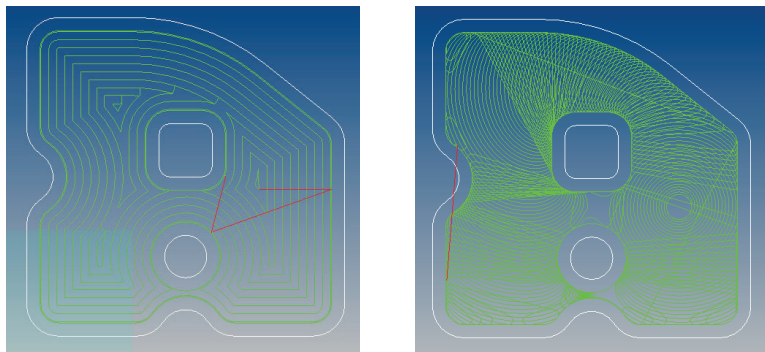

Machining 300 Series Stainless Steel

Traditional Strategy

½” 4 Flute End Mill
 290 SFM
 0.0027 IPT
 0.5XD Axial DOC
 0.3XD Radial WOC
 22 Minute Cycle

HSM Strategy

½” 4 Flute End Mill
 720 SFM
 0.0046 IPT
 1.5XD Axial DOC
 0.1XD Radial WOC
 11 Minute Cycle

High Efficiency Machining is a strategy combining HSM and modern CAM software capabilities. HEM strategy uses paths that create consistent chip load, avoiding sharp turns and crunching in corners. Utilizing chip thinning calculation, light radial depths of cut allow for faster feed rates with the same actual chip thickness. This not only allows for parts to be machined faster, but also is much easier on tooling.

Entry Methods

Plunge • Ramp • Helix • Pilot

The simplest way, and harshest way, to enter a pocket is to plunge into the part. Using a decreased feed rate, plunge to the desired depth and then start milling. This is extremely rough on tools and will lead to a short tool life, especially in harder materials.

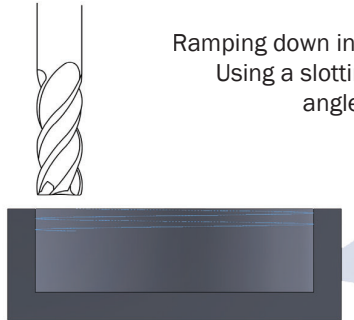

Ramping down in a straight line offers an advantage over plunging. Using a slotting speed/feed and ramping down at a 1-3 degree angle promote less tool wear than traditional plunging.

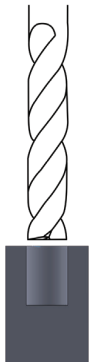

Helical ramp entry has always been known as a preferred method to enter a pocket. Using a slotting speed/feed and helixing down at a 1-3 degree angle promote less tool wear than traditional plunging.

Another common method to enter a pocket is to drill a pilot hole using a standard point drill. This leaves a drill point angle at the bottom of the pocket that must be cleaned up with the end mill.

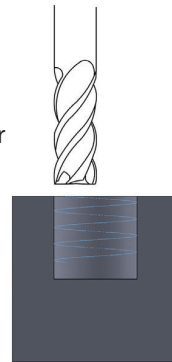

Nachi offers a unique solution to pilot the starting hole with our Aqua EX Flat Bottom Drill. Creating this pilot hole allows for plunging straight down and getting to work. This eliminates the need to mill out a drill point angle at the bottom of the pocket. This is the fastest way, and the best method for tool life.

Finishing Methods

Radial width of cut can play an important role in finishing. When taking a finish pass, it is important to keep the cutter engaged enough that it does not chatter. Two common methods can be used to eliminate chatter.

Taking a heavier cut can engage the tool more and prevent it from vibrating too much.

Tipping the balance between RPM and feed rate can engage the tool more to decrease vibration. Try decreasing RPM 5 or 10%, or increasing feed rate 5 or 10%.

Hard Milling Read Your Chips

When hard milling, it is important to use air blow rather than coolant. Due to the high heat generated while machining hard materials, using coolant can cause a pulsating hot and cold effect that causes the carbide to fracture.



✓ Good

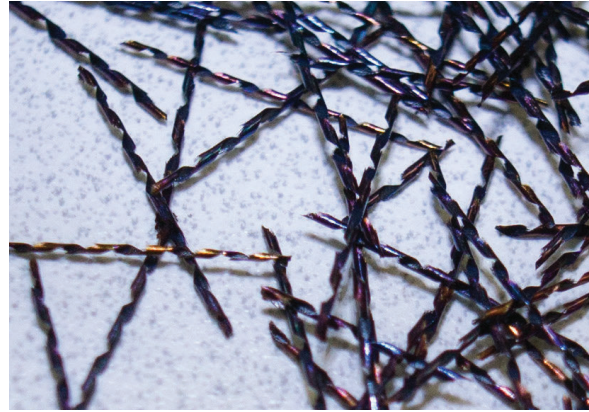

✓ Good



It is important to read your chips while hard milling. The goal is to machine just enough material to pull the heat out in the chip. This will cause the chips to discolor, being blue, gold, purple, etc.





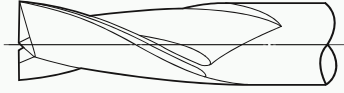
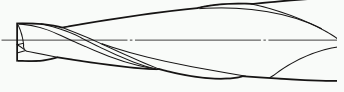

✗ Bad

A chip that is silver in color is a good indicator that the heat generated from milling is being left in the material and in the tool. This will lead to decreased tool life. This can also indicate that the tool is worn and near the end of its life.

The Peripheral Teeth and the Features

Type	Form	Features
Square Type		<ul style="list-style-type: none"> Used for general purpose, that is slotting, side milling, etc. Used for every cutting. That is rough cut, semi-finish cut and finish cut.
Tapered Type		<ul style="list-style-type: none"> Used for milling of draft angle of die components. The peripheral teeth is taper.
Roughing Type (HOG)		<ul style="list-style-type: none"> Suitable for rough milling, because of the small cutting resistance, and small cutting chips by the wavy type nicks. Do not use for finish milling because of too much roughness.
HEAVY Type (Roughing and Finishing)		<ul style="list-style-type: none"> The cutting resistance is larger than roughing end mill, but smaller than square teeth end mill. Suitable for semi-finish milling and parts which do not require accurate tolerance.

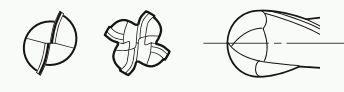
The End Teeth and the Features

Type	Form	Features
Square Type with Center Hole		<ul style="list-style-type: none"> Used for general purpose, that is slotting, side milling, etc. Cannot be used for plunge feed.
Square Type without Center Hole		<ul style="list-style-type: none"> Used for general purpose, that is slotting, side milling, etc. Can be used for plunge feed. 2 Flutes is better than multi-flutes for plunge cut.
Ball		<ul style="list-style-type: none"> Used for contour milling or copy milling of die components. The center of teeth does not have better cutting performance because of too small chip pocket and cutting speed.
Corner Radius		<ul style="list-style-type: none"> Suitable for radius shape milling for corner of die components or machine parts. Suitable for high-speed contour milling because of it's rigidity.

1. Correct Selection of End Mills

It is necessary to choose the most suitable end mills considering cutting efficiency, accuracy and so on for high efficient machining.

Tool Material

HSS-Co (equivalent to SKH59) shows excellent performance for cutting normal steel to non-ferrous alloy and cast iron. Select coated HSS, PM-HSS, FAX or Carbide for more efficient and long lasting milling.

Number of Flutes

Generally, 2 Flute is used for slot milling because of its wide chip pocket. 4 Flute is used for side milling because of its high rigidity.

Helix Angle

Generally 30° is used because better surface finish is obtained by helix angle around 30°. Lower helix is good for keyway slotting because the slot inclination is small. The bigger is the helix, the better will be the surface finish so that the high helix end mills will be used for contour milling.

Guidance for Number of Flutes Selection

Functions	Characteristics	No. of Flutes	
		2 Flute	4 Flute
Strength	Twist Rigidity	○	◎
	Bending Rigidity	○	◎
Surface Finish	Roughness	○	◎
	Waving	○	◎
	Inclination	○	◎
Tool Life S50C (200HB)	Feed (mm/tooth)	○	◎
	Wear Constant Broken	○	◎
SKD11 (320HB)	Feed (mm/tooth)	○	◎
	Wear Constant Broken	○	◎
Chip Disposal	Chip Jam	○	◎
	Chip Exhaust	○	◎
Resharpener	Out Dia. Relief	◎	○
	End Teeth	◎	○
Form Modify	Ball Nose, Taper Form	◎	○

◎ Great ○ Good

Functions	Characteristics	No. of Flutes	
		2 Flute	4 Flute
Drilling	Counter Sink	◎	○
	Surface Roughness	◎	○
	Enlargement of Holes	◎	○
Cutting	Finishing	○	◎
	Light Duty	○	◎
	Heavy Duty	○	◎
Slotting	Chip Exhaust	◎	○
	Enlarge, Eccentricity	◎	○
	Keyway Cutting	◎	○
Side Milling	Milling Accuracy	○	◎
	Chattering Vibration	◎	○
Work Material	Alloy Steel	○	◎
	Cast Iron	○	◎
	Non-ferrous Material	◎	○
	Difficult Machining	○	◎

◎ Great ○ Good

END MILL TECHNICAL

Characteristics of End Mill Helix

Range of Helix Angle	Cutting Resistance			Surface Accuracy			Tool Life			Resharpener	
	Torque	Bending	Thrust	Roughness	Waving	Inclination	Flank Wear	Out Dia. Downsize	Breakage	Peripheral Relief	End Teeth
Low Helix	○	○	●	○	●	●	○	△	○	●	●
Standard Helix	●	●	○	●	○	○	●	○	●	●	●
High Helix	●	●	△	●	△	○	○	●	○	○	○

● Great ○ Good △ OK – Judging from usage of end mills

TROUBLE-SHOOTING GUIDE FOR END MILL PROBLEMS

	Problem	Factors	Countermeasures
Surface Roughness	Rough Finish	Chatter	<ul style="list-style-type: none"> Increase rigidity of workpiece fixture Check machine condition, horsepower (H,P) Reduce cutting speed Consider conventional (up-cut) milling Use shortest possible length of tool, consider using special long reach holder
		Uneven hardness of workpiece	<ul style="list-style-type: none"> Use even hardness material
		Insufficient rake or relief	<ul style="list-style-type: none"> Resharpener cutter to correct geometry to suit cutting conditions
		Built-up edge, cold welding	<ul style="list-style-type: none"> Remove built-up edge & cold welding Check deterioration of cutting fluid
		Dull cutting edge	<ul style="list-style-type: none"> Provide timely resharpening
		Speed too high	<ul style="list-style-type: none"> Reduce cutting speed
		Improper or lack of cutting fluid	<ul style="list-style-type: none"> Change cutting fluid or lubricating system
	Torn Finish	Uneven wear on teeth	<ul style="list-style-type: none"> Remove wear by regrinding
		Cold welding on teeth	<ul style="list-style-type: none"> Remove cold welding Change cutting fluid
		Bruise on teeth	<ul style="list-style-type: none"> Handle end mill carefully
	Waviness	Too small number of flutes Heavy cutting conditions Helix angle too big	<ul style="list-style-type: none"> Try multi flute end mill, 2Fl/3Fl/4FL Reduce amount of radial depth of cut and feed Use lower helix angle end mill
	Form Error	Squareness (Perpendicularity)	Heavy cutting conditions Excessive overhang of cutter or workpiece Angular error of fixture
Tool Life	Short Life per Resharpening	Material too hard	<ul style="list-style-type: none"> Provide proper annealing Reduce feed and use upper grade material end mill
		Incorrect feed	<ul style="list-style-type: none"> Define proper feed
		Built-up edge, cold welding	<ul style="list-style-type: none"> Remove built-up edge or cold welding Use activative cutting fluid
		Insufficient coolant	<ul style="list-style-type: none"> Use proper cutting fluid Increase rate of coolant flow
		Incorrect resharpening	<ul style="list-style-type: none"> Resharpener cutter to correct geometry to suit cutting conditions
	Total Tool Life Too Short	Less number of resharpening	<ul style="list-style-type: none"> Regrind relief angle smaller Provide proper resharpening amount
		Improper time of resharpening	<ul style="list-style-type: none"> Provide timely resharpening
	Excessive Wear	Material defect of workpiece	<ul style="list-style-type: none"> Use evenness hardness material
		Improper rake or relief	<ul style="list-style-type: none"> Resharpener cutter to correct geometry to suit cutting conditions
		Insufficient performance of end mill	<ul style="list-style-type: none"> Use upper grade material end mill Try to use coated end mill
		Unsuitable cutting fluid	<ul style="list-style-type: none"> Select proper cutting fluid Correct lubricating system
		Improper time of resharpening	<ul style="list-style-type: none"> Provide timely resharpening
		Incorrect resharpening	<ul style="list-style-type: none"> Improve surface roughness on resharpening Prevent overheat of cutter grinding Remove built-up edge and weld deposit
	Chipping or Cracking	Chatter	<ul style="list-style-type: none"> Increase rigidity of workpiece fixture
		Material defect or workpiece	<ul style="list-style-type: none"> Use even hardness material Remove abnormal parts such as scale, sandtumbling etc.
		Feed too high	<ul style="list-style-type: none"> Reduce feed speed
		Dull cutting edge	<ul style="list-style-type: none"> Provide resharpening
		Deterioration of cutting fluid	<ul style="list-style-type: none"> Provide new cutting fluid
	Breakage	Lack of rigidity in set-up	<ul style="list-style-type: none"> Check component or fixture for security and rigidity
		Dull cutting edge	<ul style="list-style-type: none"> Provide Resharpening
		Careless handling	<ul style="list-style-type: none"> Handle end mill carefully
Chip cram		<ul style="list-style-type: none"> Remove chips by air-jet cutting fluid 	

END MILL TECHNICAL

TAPS



SGSP - DIN Spiral Fluted Taps

NACHI

SGPO - DIN Spiral Pointed Taps



Features:

- Made from high grade powder HSS and SG coating for longer tool life
- High flexibility for superior performance on a variety of materials, machines, and cutting conditions
- Stable cutting threads and long tool life regardless of cutting speed
- Achieves easy flow of chips while cutting on Stainless Steels, Structural Steels and Aluminum Alloys

Features

- Made from high grade powder HSS and SG coating for longer tool life
- Optimized edge and flute shape allow for stable cutting threads, high rigidity and chip ejection
- High flexibility for superior performance on a variety of materials, machines, and cutting conditions
- Stable cutting threads and long tool life regardless of cutting speed
- Achieves easy flow of chips while cutting on Stainless Steels, Structural Steels and Aluminum Alloys
- ANSI Shank DIN Overall Length



Work Materials

- Covers a wide range of applications -
 - Aluminum
 - Alloy Steel
 - Cast Iron
 - Stainless Steel
 - Carbon Steel

Properties

Properties of NACHI Premium P-HSS
High toughness can be obtained even at high hardness levels



Performance

Long tool life with Stainless Steels

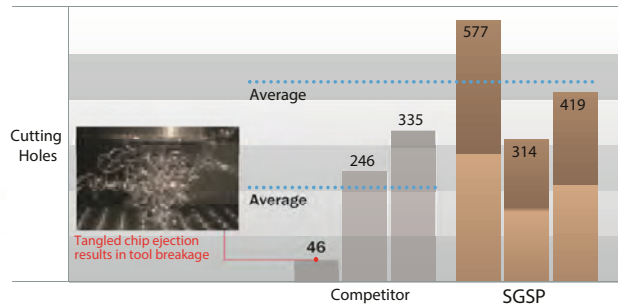

Tapping Condition: M6 x 1, Depth 12 mm, 25 SFM
304 Stainless Vertical m/c

Characteristics

Characteristics of SG Coating

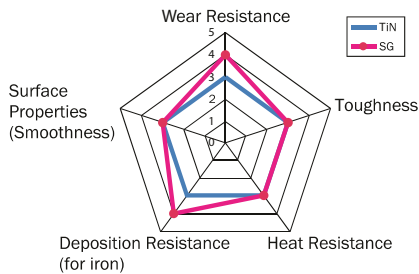

Composite multi-layer film coating method characterized by improved wear resistance as compared to TiN.

SG Coating (Tin + TiCN)

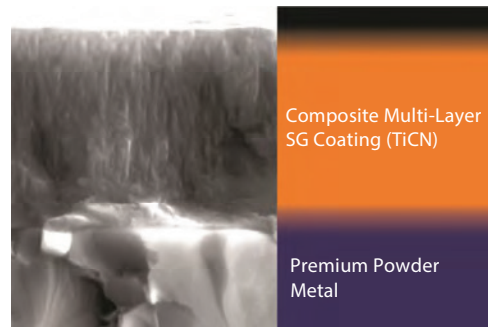

Application

Selection Chart

●: Great ○: Good △: OK

Carbon Steel			Alloy Steel 4140,4340	Die Steel ~20Hrc D2,H13	Aluminum 6061 7075	Stainless Steel			Cast Iron Grey Ductile	Nickel Alloy	Titanium Alloy	Hardened Steel >35Hrc
Low Carbon 1010,1018	Medium Carbon 1035,1045	High Carbon 1065,1095				300 Series	400 Series	17-4PH				
●	●	●	●	○	○	●	○	△	○		△	

Features

- Nachi ViperTafletTaps are specially engineered for steels, and require less torque than conventional coldform taps. This reduces the chance of breakage.
- Nachi ViperTafletTaps are steam oxide surface treated to limit adhesion from fusion, and carries coolant to the work area. Bright finish is available when required.
- Nachi ViperTafletTaps have more radial sections for higher accuracy of internal threads in steel. This compares favorably to coldform internal threads, which aren't always clean and accurate.



VIPER TAFLET

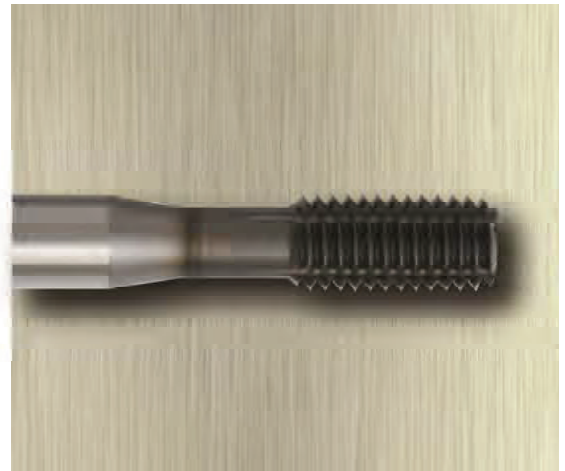

DLC Taplet

Work Materials

- Structural Steels
- Carbon Steels
- Alloy Steels
- Stainless Steels
- Aluminum Alloys

Performance

TAFLET

Fiber flow is:

NOT INTERRUPTED

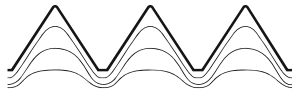

Female thread cut by a TAFLET

Cutting Tap

Fiber flow is:

INTERRUPTED

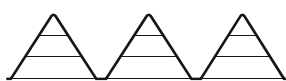

Female thread cut by a cutting tap

DLC TAFLET

Semi-Dry Tapping

Forming tap with DLC coating can be used in Aluminum, Aluminum Alloys, Die Cast Aluminum.

The tap shown below, M6x1.0, tapped 1,000 holes in A6061 with mist hole lube applied and has minimum adhesion of material.

Tapping Condition

Size	M6x1.0
Material	A6061-T6
Speed	15 m/min (49.2 SFM)
Feed	1.0 mm/rev (0.039 IPM)
Depth of Thread	13 mm
Coolant	Mist Lube (25cc x 2 nozzle/h)

Features of Taflet

Item	Cutting Tap	Taflet	Taflet Features
Tap breakdown	×	○	Does not break because there is no groove
Trouble caused by chips	×	○	No trouble because there is no chip
Accuracy of female thread	×	○	Little variations because of cold forming tapping
Female thread surface roughness	×	○	Excellent because threads are finished by sliding over the tap surface
Tapping torque	○	×	1.5 through 2.5 times the torque of a cutting tap
Female thread strength	×	○	Excellent because fiber flow is not interrupted in plastic working
Workpiece	○	×	Limited to the material of good malleability

1000 Hole

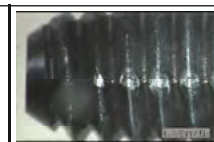

Viper Taflet Taps Thread Forming

Features

- NACHI Viper Taflet taps are designed for economical and efficient tapping of steel.
- No chips are produced with Taflet Taps, the threads are formed by the displacement of the metal. Threads produced this way are generally more accurate and stronger than threads produced by conventional tapping.

Performance

Advantages of NACHI Viper Taflet Taps

Conventional coldform taps for steel require high torque. NACHI Viper Taflet taps have been specially engineered for steels and require less torque, reducing the chance of breaking.

In conventional coldform threading, rapid wear and adhesion due to high frictional heat may occur. NACHI Viper Taflet tap's steam oxide surface treatment limits adhesion from fusion and carries coolant to the work area. Bright finish is also available when required.

Conventional coldform internal threads aren't always clean and accurate. NACHI Viper Taflet taps have more radial sections for higher accuracy of internal threads in steel.



Features

- VTP Series are suitable for various material.

Work Materials

- Structural Steels
- Alloy Steels
- Aluminum Alloys
- Carbon Steels
- Stainless Steels



Performance

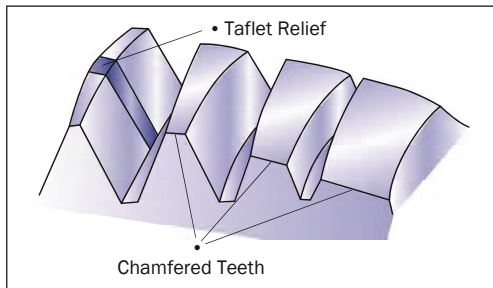

Nachi VTP Series Taps were specifically designed to overcome the major difficulties of spiral fluted taps: oversizing and chip control. An all-new approach to these limitations also provides double-action tapping - cutting with chamfered teeth, *plus cold rolled forming with a specially engineered shape of thread that we call Taflet Relief.*

The results provide two-fold benefits. The first is minimal or no oversized thread diameter over the entire thread length, with smooth thread surfaces. The second is smooth chip ejection, ensuring freedom from chips for trouble-free performance, especially on machining centers and on unattended machining lines.













Conventional Taps VTP-Series Taps



VTP Series Taps

TAPS

HIGH PERFORMANCE TAPS









List No.	Tap Name	Chamfer	Material	Coating	Stock Size	Product Page		
SG Tap Series								
6800		Modified Bottoming	PM-HSS	SG	Metric	M3 to M24	p. 222-223	
6801					Fractional	1/4 to 1	p. 222-223	
6801					Machine Screw	2 to 12	p. 222-223	
6802		Plug	PM-HSS	SG	Metric	M3 to M24	p. 224-225	
6803					Fractional	1/4 to 1	p. 224-225	
6803					Machine Screw	2 to 12	p. 224-225	
6958		Modified Bottoming	HSSE	SG	Metric	M3 to M24	p. 226-227	
6959					Fractional	1/4 to 1	p. 226-227	
6959					Machine Screw	2 to 12	p. 226-227	
Taflet Thread Forming Series								
6956		Plug & Bottom	HSSE-V	DLC	Metric	M3 to M24	p. 228-229	
6955					Fractional	1/4 to 1	p. 228-229	
6957					Machine Screw	2 to 12	p. 228-229	
996		Plug & Bottom	HSSE-V	Black Oxide	Metric	M3 to M24	p. 230	
995					Fractional	1/4 to 1	p. 231-232	
995					Machine Screw	2 to 12	p. 231-232	
VTP Spiral Flute Series								
980		Modified Bottoming	HSSE-V	Black Oxide	Metric	M3 to M24	p. 233	
981					Fractional	1/4 to 1	p. 234	
983					Machine Screw	2 to 12	p. 234	
982		Plug	HSSE-V	Black Oxide	Metric	M3 to M24	p. 233	
971					Fractional	1/4 to 1	p. 235	
973					Machine Screw	2 to 12	p. 235	
General Purpose Hand Tap Series								
911		Standard Hand Tap	Taper, Plug, & Bottom	HSSE-V	Bright	Fractional	1/ to 1-1/2	p. 236
913		Standard Hand Tap				Machine Screw	0 to 12	p. 237
910		Standard Hand Tap	HSS	HSSE-V	Black Oxide	Metric	M2 to M30	p. 240
969		Hand Tap for Cast Iron	Plug & Bottom			Fractional	1/4 to 3/14	p. 238

● : Great ○ : Good Δ : OK - : Not Recommended

List No.	Cutting Condition Page	Workpiece Material															
		Carbon Steel	Alloy Steel	Pre Hardened Steel	Die Steel	Hardened Steel			Stainless Steel		PH Stainless	Titanium Alloys	Nickel Alloys	Cast Iron	Ductile Cast Iron	Aluminum Alloy	Copper Alloys
						HRc			Austenitic 300 Series	Martensitic 400 Series							
			20 ~ 30		25 ~ 40	40 ~ 50	50 ~ 65										
6800	p. 222																
6801	p. 222	●	●	●	○	-	-	●	●	○	-	-	-	○	○	○	
6801	p. 222																
6802	p. 224																
6803	p. 224	●	●	●	○	○	-	●	●	○	-	-	○	○	○	○	
6803	p. 224																
6958	p. 226																
6959	p. 226	○	○	○	●	Δ	-	-	-	-	-	-	Δ	Δ	-	-	
6959	p. 226																
6956	p. 228																
6955	p. 228	-	-	-	-	-	-	-	-	-	-	-	-	-	●	●	
6957	p. 228																
996	p. 231																
995	p. 231-232	●	○	-	-	-	-	○	○	Δ	-	-	-	-	-	-	
995	p. 231-232																
980	p. 235																
981	p. 235	●	●	○	-	-	-	Δ	Δ	Δ	-	-	○	○	○	○	
983	p. 235																
982	p. 235																
971	p. 235	●	●	○	-	-	-	Δ	Δ	Δ	-	-	○	○	○	○	
973	p. 235																
911	p. 244	Δ	Δ	Δ	-	-	-	-	-	-	-	-	Δ	Δ	Δ	Δ	
913	p. 244	Δ	Δ	Δ	-	-	-	-	-	-	-	-	Δ	Δ	Δ	Δ	
910	p. 244	Δ	Δ	Δ	-	-	-	-	-	-	-	-	Δ	Δ	Δ	Δ	
969	p. 244	Δ	Δ	Δ	-	-	-	-	-	-	-	-	●	●	-	-	

TAPS

STANDARD TAPS

List No.	Tap Name	Chamfer	Material	Coating	Stock Size	Product Page
General Purpose Spiral Point Tap Series						
923	 Standard Spiral Point	Plug	HSS	Bright	Machine Screw	0 to 12 p. 239
921	 Standard Spiral Point		HSSE-V		Fractional	1/4 to 3/4 p. 238
920	 Standard Spiral Point		HSS		Metric	M2.5 to M16 p. 240
General Purpose Pipe Tap Series						
941 941D	 Taper Straight Fluted		HSS	Bright	NPT NPTF	1/16 to 2 p. 241
943 943D	 Taper Interrupted				NPT NPTF	1/8 to 1 p. 241
947 947D	 Taper Spiral Fluted		HSSE-V	Black Oxide	NPT NPTF	1/16 to 1 p. 242
945 945D	 Straight Pipe Tap		HSS	Bright	NPS NPSF	1/8 to 1 p. 242
959 959D	 Short Projection				NPT NPTF	1/8 to 1 p. 243
957	 6" Extension				NPT	1/16 to 1 p. 243

● : Great ○ : Good Δ : OK - : Not Recommended

List No.	Cutting Condition Page	Workpiece Material															
		Carbon Steel	Alloy Steel	Pre Hardened Steel	Die Steel	Hardened Steel			Stainless Steel		PH Stainless	Titanium Alloys	Nickel Alloys	Cast Iron	Ductile Cast Iron	Aluminum Alloy	Copper Alloys
						HRc			Austenitic 300 Series	Martensitic 400 Series							
			20 ~ 30		25 ~ 40	40 ~ 50	50 ~ 65										
923	p. 244	Δ	Δ	Δ	-	-	-	-	-	-	-	-	Δ	Δ	Δ	Δ	
921	p. 244	Δ	Δ	Δ	-	-	-	-	-	-	-	-	Δ	Δ	Δ	Δ	
920	p. 244	Δ	Δ	Δ	-	-	-	-	-	-	-	-	Δ	Δ	Δ	Δ	
941 941D	p. 244	Δ	Δ	Δ	-	-	-	-	-	-	-	-	Δ	Δ	Δ	Δ	
943 943D	p. 244	Δ	Δ	Δ	-	-	-	-	-	-	-	-	Δ	Δ	Δ	Δ	
947 947D	p. 244	○	○	○	-	-	-	-	-	-	-	-	○	○	○	○	
945 945D	p. 244	○	○	○	-	-	-	-	-	-	-	-	○	○	○	○	
959 959D	p. 244	Δ	Δ	Δ	-	-	-	-	-	-	-	-	Δ	Δ	Δ	Δ	
957	p. 244	○	○	○	-	-	-	-	-	-	-	-	○	○	○	○	

TAPS

SGSP-DIN Spiral Fluted Tap

- Modified Bottoming Style 2.5 Thread Chamfer
- SG Coating
- DIN Overall Length
- Premium Powdered High Speed Steel

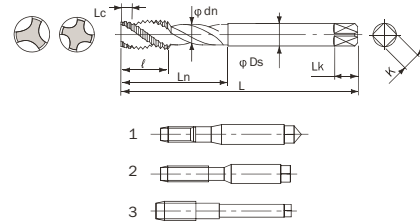

List 6800 Metric Sizes

Size	Thread Limit	EDP No	No. of Flutes	Dimensions				
				Overall Length	Length of Thread	Under Neck Length	Shank Dia.	Style
METRIC SIZES				L	ℓ	Ln	Ds	
M3 X 0.5	D3	1486233	3F	2.205	0.228	0.626	0.141	1
M4 X 0.7	D4	1486256		2.480	0.307	0.689	0.168	
M5 X 0.8		1486262		2.756	0.374	0.874	0.194	
M6 X 1.0		1486279		3.150	0.453	1.000	0.255	2
M8 X 1.25	D5	1486307		3.543	0.594	1.126	0.318	
M10 X 1.25		1486313		3.937		1.252	0.381	
M10 X 1.5		1486320			4.331	0.740	1.425	0.367
M12 X 1.25	D6	1486336		0.634				
M12 X 1.5		1514479		0.780				
M12 X 1.75		1486342		4F	0.882	1.669	0.429	3
M14 X 2.0		1514491	1.024					
M16 X 2.0	D7	1514513	1.280					
M18 X 2.5		1514536	4.921	1.280	1.937	0.542		
M20 X 2.5		1514559	5.512	1.996	0.652			
M24 X 3.0	D8	1514594	6.299	1.535	2.323	0.760		

1 piece per package

⚠ WARNING: Cancer - www.P65Warnings.ca.gov

SGSP Work Material & Cutting Condition Recommendations

Work Material	Tapping Speed SFM		
Low Carbon Steel	1010 1018	80 - 100	
Medium Carbon Steel	1035 1045	80 - 100	
High Carbon Steel	1065 1095	80 - 100	
Alloy Steel	4140 4130	25 - 45	
Die Steel	D2 H13 (up to 20 HRC)	20 - 40	
Hardened Steel	~ 35 HRC	15 - 35	
Stainless Steel	Austenitic	303 304 316	10 - 25
	Martensitic	410 430	10 - 25
		17-4PH	10 - 25
Aluminum	6061 7075 Casting	80 - 100	
Cast Iron	Grey Nodular	90 - 110	

HIGH PERFORMANCE TAPS

SGSP-DIN Spiral Fluted Tap

- Modified Bottoming Style 2.5 Thread Chamfer
- SG Coating
- DIN Overall Length
- Premium Powdered High Speed Steel

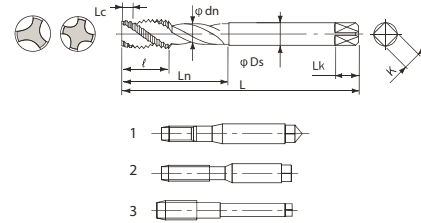

List 6801 Machine Screw & Fractional Sizes

Size	Thread Limit	No. of Flutes	EDP No	Dimensions				
				Overall Length	Length of Thread	Under Neck Length	Shank Dia.	Style
MACHINE SCREW SIZES								
2-56	H2	3F	1539482	1.772	0.441	0.591	0.141	1
4-40	H2		1539499	2.205	0.272	0.563		
6-32	H2		1540459			0.689		
	H3		1486439	2.480	0.374	0.752		
8-32	H2		1540465			0.194		
	H3		1486451					
10-24	H3		1486474	2.756	0.496	0.874		
10-32	H2		1540471			0.937		
	H3		1486480					
12-24	H3		1486497	3.150		0.220		
FRACTIONAL SIZES								
1/4 - 20	H3	3F	1486519	3.150	0.606	1.000	0.255	1
	H5		1540488					
1/4 - 28	H3		1486525	3.543	0.413	1.126	0.318	2
	H4		1540494					
5/16 - 18	H3		1486531	3.937	0.697	1.252	0.381	3
	H5		1540500					
5/16 - 24	H3		1486548	3.543	0.480	1.236	0.323	3
	H4		1540516					
3/8 - 16	H3		1486554	4.331	0.783	1.425	0.367	3
	H5		1540522					
3/8 - 24	H3	1486560	3.937	0.480	1.748	0.480	3	
	H4	1540539						
7/16 - 14	H3	1486577	4.921	0.894	1.937	0.590	3	
	H5	1540545						
7/16 - 20	H3	1486583	4.331	0.626	2.323	0.800	3	
	H5	1540551						
1/2 - 13	H3	1486590	3.937	1.024	1.425	0.367	3	
	H5	1540568						
1/2 - 20	H3	1486605	4.331	0.646	1.748	0.480	3	
	H5	1540574						
5/8 - 11	H4	1514622	4.921	1.185	1.937	0.590	3	
	H6	1540580						
5/8 - 18	H4	1514639	4.331	0.732	2.323	0.800	3	
	H6	1540597						
3/4 - 10	H4	1514645	4.921	1.303	1.937	0.590	3	
	H6	1540602						
3/4 - 16	H4	1514651	4.331	0.827	2.323	0.800	3	
	H6	1540619						
1 - 8	H4	1514680	6.299	1.626	2.323	0.800	3	
	H6	1540625						

Order by EDP Number
1 piece per package

⚠ WARNING: Cancer - www.P65Warnings.ca.gov

TAPS

SGPO-DIN Spiral Pointed Tap

- Plug Style 5 Thread Chamfer
- SG Coating
- DIN Overall Length
- Premium Powdered High Speed Steel

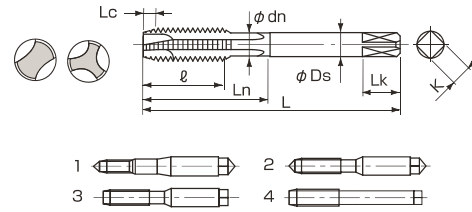

List 6802 Metric Sizes

Nominal Size	Pitch	No. of Flutes	EDP No						Dimensions				Style
			D3	D4	D5	D6	D7	D8	Overall Length	Length of Thread	Under Neck Length	Shank Dia.	
METRIC SIZES									L	ℓ	Ln	Ds	
M3	0.5	3F	1542451						2.205	0.394	0.630	0.141	2
M4	0.7	3F		1542829					2.480	0.492	0.752	0.168	
M5	0.8	3F		1542903					2.756	0.571	0.882	0.194	
M6	1.0	3F			1542910				3.150	0.669	1.000	0.255	
M8	1.25	3F			1542926				3.543		1.181	0.318	3
M10	1.25	3F			1542932				3.937	0.866	1.437	0.381	
M10	1.5	3F				1542949				1.063			
M12	1.25	3F			1542955					0.906	-		
M12	1.5	3F				1542978			1.102	-		0.367	4
M12	1.75	3F				1542961				-			
M14	2.0	3F					1542468		4.331	1.260	-	0.429	
M16	2.0	3F					1542474				-	0.480	
M18	2.5	3F					1542480		4.921	1.476	-	0.542	
M20	2.5	3F					1542497		5.512		-	0.652	
M24	3.0	3F						1542502	6.299	1.772	-	0.760	

Order by EDP Number
1 piece per package

⚠ WARNING: Cancer - www.P65Warnings.ca.gov

SGPO Work Material & Cutting Condition Recommendations

Work Material		Tapping Speed SFM
Low Carbon Steel	1010 1018	70 - 90
Medium Carbon Steel	1035 1045	90 - 110
High Carbon Steel	1065 1095	90 - 110
Alloy Steel	4140 4130	45 - 65
Die Steel	D2 H13 (up to 20 HRC)	25 - 45
Hardened Steel	~ 35 HRC	15 - 35
Stainless Steel	Austenitic 303 304 316	10 - 30
	Martenitic 410 430	10 - 30
	17-4PH	10 - 30
Aluminum	6061 7075 Casting	100 - 120
Cast Iron	Grey Nodular	110 - 130

SGPO-DIN Spiral Pointed Tap

- Plug Style 5 Thread Chamfer
- SG Coating
- DIN Overall Length
- Premium Powdered High Speed Steel

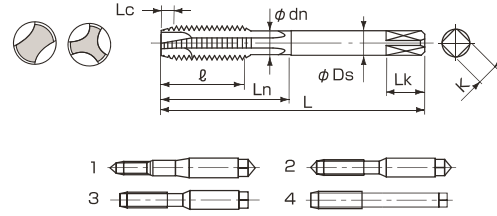

List 6803 Machine Screw & Fractional Sizes

Nominal Size	Thread/Inch		No. of Flutes	EDP No					Dimensions				Style
	NC/UNC	NF/UNF		H2	H3	H4	H5	H6	Overall Length	Length of Thread	Under Neck Length	Shank Dia.	
MACHINE SCREW SIZES													
									L	l	Ln	Ds	
2	56		2F	1543378					1.772	0.441	0.591	0.141	1
4	40		2F	1543384					2.205	0.469	0.602		
6	32		3F	1542519	1542525				2.480	0.555	0.768	0.168	2
8	32		3F	1542531	1542548								
10	24		3F		1542554			2.756	0.709	0.984	0.194		
		32	3F	1542560	1542577				0.555				
12	24		3F		1542583			3.150	0.709		0.220		
FRACTIONAL SIZES													
1/4	20		3F		1542590		1542605	3.150	0.850	1.181	0.255		
		28	3F		1542611	1542628			0.618				
5/16	18		3F		1542634		1542640	3.543	0.945	1.299	0.318	3	
		24	3F		1542657	1542663			0.709				
3/8	16		3F		1542670		1542686	3.937	1.063	1.457	0.381		
		24	3F		1542692	1542708			0.709				
7/16	14		3F		1542714		1542720	3.937	1.142	-	0.323		
		20	3F		1542737		1542743		0.902				
1/2	13		3F		1542750		1542766	4.331	1.232	-	0.367		
		20	3F		1542772		1542789		0.902				
5/8	11		3F			1542795		1542800	4.331	1.181	-	0.480	4
		18	3F			1542817		1542823		0.835			
3/4	10		3F			1542830		1542846	4.921	1.299	-	0.590	
		16	3F			1542852		1542869		0.937			
1	8		3F			1542875		1542881	6.299	1.626	-	0.800	

Order by EDP Number
1 piece per package

⚠ WARNING: Cancer - www.P65Warnings.ca.gov

TAPS

SG Lo-Spiral Fluted Tap



Modified Bottoming Style 2 1/2 to 3 Thread Lead
SG Coating

List No. 6958 Metric Sizes

*GT to H-limit conversion chart refer to Page: 226

Nominal Size (mm)	Pitch (mm)	E.D.P. Numbers					No. Of Flutes	Dimensions		
		GT5	GT6	GT7	GT8	GT9		Overall Length	Length of Thread	Shank Dia.
METRIC										
M3	0.5	59615					3	1 15/16	0.236	0.141
M4	0.7	59617						2 1/8	0.276	0.168
M5	0.8		59619					2 3/8	0.354	0.194
M6	1		59620					2 1/2	0.433	0.255
M8	1		59622					2 23/32	0.472	0.318
	1.25		59623							
M10	1.25		59624					2 15/16	0.551	0.381
	1.5			59625						
M12	1.25				59626			3 3/8	0.669	0.367
	1.75				59627					
M14	1.5				59628		3 19/32	0.787	0.429	
	2				59629					
M16	1.5				59630		3 13/16	0.787	0.480	
	2				59631					
M18	1.5				59632		4 1/32	0.984	0.542	
	2.5					59633				
M20	1.5				59634		4 15/32	0.984	0.652	
	2.5					59635				
M22	1.5				59636		4 11/16	0.984	0.697	
	2.5					59637				
M24	1.5				59638		4 29/32	1.181	0.760	
	3					59639				

Order by EDP Number

Tapping Speeds

SG-Low Spiral Taps List No. 6958, 6959
SFM : Surface Feet per Minutes

Work Materials		Tapping Speed SFM
Low Carbon Steel	1010,1018	25-50
Medium Carbon Steel	1035,1045	20-50
High Carbon Steel	1065,1095	15-30
Alloy Steel	4140,4130	15-30
Die Steels	D2,H13	15-35
Hardened Die Steels (20-40HRC)	D2,H13	8-15
Stainless Steel (Austenitic)	303,304,316	15-45
Stainless Steel (Martensitic)	410,430	12-20
Stainless Steel (PH) up to 35HRC	17-4PH	12-20
Titanium Alloy Up to 32HRC	6AL4V	15-20
Magnesium Alloy		40-80
Ductile Cast Irons	80-55-06	20-50
Cast Irons	Nodular,Grey	30-65

- These are general tapping condition, may be altered by your condition.
- These conditions are for tapping depth 1.5D. In case of deeper thread you may multiply these values by the coefficient of next table.

Thread Depth	Coefficient
Up to 1.5D	1
1.5D ~ 2.5D	0.9
2.5D ~ 3D	0.8
Over 3D	0.7

SG Lo-Spiral Fluted Tap



Modified Bottoming Style 2 1/2 to 3 Thread Lead
SG Coating

List No. 6959 Machine Screw & Fractional Sizes

*GT to H-limit conversion chart refer to Page: 226

Nominal Size	Thread/Inch		E.D.P. Numbers							No. of Flutes	Dimensions			
	NC UNC	NF UNF	GT3	GT4	GT5	GT6	GT7	GT8	GT9		Overall Length	Length of Thread	Shank Dia.	
MACHINE SCREW SIZES														
2	56		94597								3	1 3/4	0.437	0.141
		64	94598									1 13/16	0.500	
3	48			94599								1 7/8	0.236	
		56	94600									1 15/16		
4	40				94601							2	0.276	
		48		94602								2 1/8		
5	40				94603							2 3/8	0.354	
		44			94604							2 3/8		
6	32				94605							2 3/8	0.354	
		40			94606							2 3/8		
8	32				94607							2 3/8	0.354	
		36			94608							2 3/8		
10	24					94609					2 3/8	0.354		
		32			94610						2 3/8			
12	24					94611					2 3/8	0.354		
		28			94612						2 3/8			
FRACTIONAL SIZES														
1/4	20			94633			94613				3	2 1/2	0.433	0.255
		28		94634		94614						2 23/32	0.472	0.318
5/16	18			94635			94615					2 15/16	0.551	0.381
		24		94636			94616					3 5/32	0.709	0.323
3/8	16			94637				94617				3 3/8	0.787	0.367
		24		94638			94618					3 19/32	0.827	0.429
7/16	14							94619				3 13/16	0.905	0.480
		20		94639				94620				4 1/4	0.984	0.590
1/2	13			94640				94621				4 11/16	1.102	0.697
		20		94641				94622				5 1/8	1.260	0.800
9/16	12							94623						
		18						94624						
5/8	11								94625					
		18							94626					
3/4	10								94627					
		16							94628					
7/8	9								94629					
		14							94630					
1	8								94631					
		12							94632					

Order by EDP Number

TAPS

DLC Taflet Thread Forming Taps



Forming TAP with DLC coating can be used in Aluminum Alloy, Die Cast Aluminum and Copper.

List No. 6956 Metric Sizes ***To be discontinued in 2023**

Bottoming Style
DLC Coating

Nominal Size (mm)	Pitch (mm)	E. D. P. Numbers								Dimensions		
		D3	D4	D5	D6	D7	D8	D9	D10	Overall Length	Length of Thread	Shank Dia.
M2	0.4	91002								1 3/4	0.437	0.141
M2.5	0.45	91008								1 13/16	0.500	0.141
M3	0.5	91011								1 15/16	0.394	0.141
M4	0.7		91017							2 1/8	0.472	0.168
M5	0.8		91023							2 3/8	0.551	0.194
M6	1			91026				91027		2 1/2	0.591	0.255
M8	1.25						91035	91036		2 23/32	0.669	0.318
M10							91038			2 15/16	0.748	0.381
M12	1.75								91041			
									91047	3 3/8	0.984	0.367

Order by EDP Number

Tapping Speeds

DLC Taflet Thread Forming Taps List No. 6955, 6956, 6957

Work Materials	Tapping Speed SFM
Aluminum Alloys	70 - 130

DLC Taflet Thread Forming Tap



List No. 6955 Fractional Size ***To be discontinued in 2023**

Bottoming Style
DLC Coating

Nominal Size	Thread/Inch		E. D. P. Numbers								Dimensions		
	NC UNC	NF UNF	H2	H3	H4	H5	H6	H7	H8	H10	Overall Length	Length of Thread	Shank Dia.
1/4	20				97838		97912				2 1/2	0.591	0.255
		28			97840		97914						
5/16	18					97873		97931			2 23/32	0.669	0.318
		24				97875		97933					
3/8	16					97877		97935			2 15/16	0.748	0.381
		24				97879		97937					
7/16	14					97881			97961		3 5/32	0.866	0.323
1/2	13					97885			97965		3 3/8	0.984	0.367

Order by EDP Number



List No. 6957 Machine Screw Sizes ***To be discontinued in 2023**

Bottoming Style
DLC Coating

Nominal Size	Thread/Inch		E. D. P. Numbers								Dimensions		
	NC UNC	NF UNF	H2	H3	H4	H5	H6	H7	H8	H10	Overall Length	Length of Thread	Shank Dia.
2	56		97738	97776							1 3/4	0.437	
4	40			97784		97857					1 7/8	0.354	0.141
6	32			97792		97865					2	0.433	
8	32			97796		97869					2 1/8	0.472	0.168
10	24	32			97830		97904				2 3/8	0.551	0.194
					97832		97906						
12	24				97834		97908						0.220

Order by EDP Number

TAPS

Viper Taflet for Steel



Plug & Bottoming Style
Surface Treated

List No. 996 Metric Sizes ***To be discontinued in 2023**

VANADIUM HIGH SPEED STEEL HSSE-V

Nominal Size (mm)	Pitch (mm)	Chamfer Style*	E.D.P. Numbers									Dimensions		
			D3	D4	D5	D6	D7	D8	D9	D10	D11	Overall Length	Length of Thread	Shank Dia.
M2	0.4	P	51001	-	-	-	-	-	-	-	-	1 3/4	0.437	0.141
		B	51002	-	-	-	-	-	-	-	-			
M2.2	0.45	P	51004	-	-	-	-	-	-	-	-	1 13/16	0.500	
		B	51005	-	-	-	-	-	-	-	-			
M2.5	0.45	P	51007	-	-	-	-	-	-	-	-	1 15/16	0.394	
		B	51008	-	-	-	-	-	-	-	-			
M3	0.5	P	51010	-	-	-	-	-	-	-	-	2	0.433	
		B	51011	-	-	-	-	-	-	-	-			
M3.5	0.6	P	51013	-	-	-	-	-	-	-	-	2 1/8	0.472	
		B	51014	-	-	-	-	-	-	-	-			
M4	0.7	P	-	51016	-	-	-	-	-	-	-	2 3/8	0.551	
		B	-	51017	-	-	-	-	-	-	-			
M4.5	0.75	P	-	51019	-	-	-	-	-	-	-	2 1/2	0.591	
		B	-	51020	-	-	-	-	-	-	-			
M5	0.8	P	-	51022	-	-	-	-	-	-	-	2 23/32	0.669	
		B	-	51023	-	-	-	-	-	-	-			
M6	1	P	-	-	51025	-	-	-	-	-	-	2 15/16	0.748	
		B	-	-	51026	-	-	-	-	-	-			
M7	1	P	-	-	-	51028	-	-	-	-	-	2 15/16	0.381	
		B	-	-	-	51029	-	-	-	-	-			
M8	1	P	-	-	51031	-	-	-	-	-	-	3 3/8	0.984	
		B	-	-	51032	-	-	-	-	-	-			
M8	1.25	P	-	-	-	-	-	51034	-	-	-	3 19/32	0.429	
		B	-	-	-	-	-	51035	-	-	-			
M10	1.25	P	-	-	-	-	-	51037	-	-	-	4 1/32	0.542	
		B	-	-	-	-	-	51038	-	-	-			
M10	1.50	P	-	-	-	-	-	-	51040	-	-	4 15/32	1.181	
		B	-	-	-	-	-	-	51041	-	-			
M12	1.25	P	-	-	-	-	-	-	51043	-	-	4 15/32	1.181	
		B	-	-	-	-	-	-	51044	-	-			
M12	1.75	P	-	-	-	-	-	-	-	51046	-	4 15/32	1.181	
		B	-	-	-	-	-	-	-	51047	-			
M14	1.5	P	-	-	-	-	-	-	-	51049	-	4 15/32	1.181	
		B	-	-	-	-	-	-	-	51050	-			
M14	2	P	-	-	-	-	-	-	-	-	51052	4 15/32	1.181	
		B	-	-	-	-	-	-	-	-	51053			
M16	1.5	P	-	-	-	-	-	-	-	51055	-	4 15/32	1.181	
		B	-	-	-	-	-	-	-	51056	-			
M16	2	P	-	-	-	-	-	-	-	-	51058	4 15/32	1.181	
		B	-	-	-	-	-	-	-	-	51059			
M18	1.5	P	-	-	-	-	-	-	-	51061	-	4 15/32	1.181	
		B	-	-	-	-	-	-	-	51062	-			
M18	2.5	P	-	-	-	-	-	-	-	-	51064	4 15/32	1.181	
		B	-	-	-	-	-	-	-	-	51065			
M20	1.5	P	-	-	-	-	-	-	-	51067	-	4 15/32	1.181	
		B	-	-	-	-	-	-	-	51068	-			
M20	2.5	P	-	-	-	-	-	-	-	-	51070	4 15/32	1.181	
		B	-	-	-	-	-	-	-	-	51071			

Order by EDP Number

* P : Plug, B : Bottom

Viper Taflet for Steel



Plug & Bottoming Style
Surface Treated

List No. 995 Fractional Sizes ***To be discontinued in 2023**

VANADIUM HIGH SPEED STEEL HSSE-V

Nominal Size	Thread/Inch		Chamfer Style*	E.D.P. Numbers						Dimensions		
	NC UNC	NF UNF		H4	H5	H6	H7	H8	H10	Overall Length	Length of Thread	Shank Dia.
1/4	20		P	77837	—	77911	—	—	77978	2 1/2	0.591	0.255
			B	77838	—	77912	—	—	77979			
	28	P	77839	—	77913	—	—	77980				
		B	77840	—	77914	—	—	77981				
5/16	18		P	—	77872	—	77930	—	—	2 23/32	0.669	0.318
			B	—	77873	—	77931	—	—			
	24	P	—	77874	—	77932	—	—				
		B	—	77875	—	77933	—	—				
3/8	16		P	—	77876	—	77934	—	—	2 15/16	0.748	0.381
			B	—	77877	—	77935	—	—			
	24	P	—	77878	—	77936	—	—				
		B	—	77879	—	77937	—	—				
7/16	14		P	—	77880	—	—	77960	—	3 5/32	0.866	0.323
			B	—	77881	—	—	77961	—			
	20	P	—	77882	—	—	77962	—				
		B	—	77883	—	—	77963	—				
1/2	13		P	—	77884	—	—	77964	—	3 3/8	0.984	0.367
			B	—	77885	—	—	77965	—			
	20	P	—	77886	—	—	77966	—				
		B	—	77887	—	—	77967	—				
9/16	12		P	—	—	—	77946	—	77990	3 19/32	0.984	0.429
			B	—	—	—	77947	—	77991			
	18	P	—	—	—	77948	—	77992				
		B	—	—	—	77949	—	77993				
5/8	11		P	—	—	—	77950	—	77994	3 13/16	1.102	0.480
			B	—	—	—	77951	—	77995			
	18	P	—	—	—	77952	—	77996				
		B	—	—	—	77953	—	77997				
3/4	10		P	—	—	—	77954	—	77998	4 1/4	1.181	0.590
			B	—	—	—	77955	—	77999			
	16	P	—	—	—	77956	—	78000				
		B	—	—	—	77957	—	78001				

Order by EDP Number

* P : Plug, B : Bottom

Tapping Speeds

List No. 995, 996

Viper Taflet Thread Forming Taps

Work Materials	Tapping Speed SFM
Structural Steels/Carbon Steels	30 - 50
Alloy Steels (20-30 HRC)	20 - 30
Stainless Steel	10 - 15

Viper Taflet for Steel



Plug & Bottoming Style
Surface Treated

List No. 995 Machine Screw Sizes ***To be discontinued in 2023**

VANADIUM HIGH SPEED STEEL HSSE-V

Nominal Size	Thread/Inch		Chamfer Style*	E.D.P. Numbers						Dimensions		
	NC UNC	NF UNF		H2	H3	H4	H5	H6	H10	Overall Length	Length of Thread	Shank Dia.
0		80	B	77732	—	—	—	—	—	1 5/8	0.311	0.141
1	64		B	77734	—	—	—	—	—	1 11/16	0.374	
		72	B	77736	—	—	—	—	—			
2	56		B	77738	77776	—	—	—	—	1 3/4	0.437	
		64	B	77740	77778	—	—	—	—			
3	48		B	77742	77780	—	—	—	—	1 13/16	0.500	
		56	B	77744	77782	—	—	—	—			
4	40		P	—	77783	—	77856	—	—	1 7/8	0.354	
			B	—	77784	—	77857	—	—			
		48	P	—	77785	—	77858	—	—			
5	40		P	—	77787	—	77860	—	—	1 15/16	0.394	
			B	—	77788	—	77861	—	—			
		44	P	—	77789	—	77862	—	—			
6	32		P	—	77791	—	77864	—	77970	2	0.433	
			B	—	77792	—	77865	—	77971			
		40	P	—	77793	—	77866	—	—			
8	32		P	—	77795	—	77868	—	77972	2 1/8	0.472	
			B	—	77796	—	77869	—	77973			
		36	P	—	77797	—	77870	—	—			
10	24		P	—	—	77829	—	77903	77974	2 3/8	0.551	
			B	—	—	77830	—	77904	77975			
		32	P	—	—	77831	—	77905	77976			
12	24		P	—	—	77832	—	77906	77977	2 3/8	0.551	
			B	—	—	77833	—	77907	—			
		28	P	—	—	77835	—	77909	—			
			B	—	—	77836	—	77910	—		0.220	

Order by EDP Number

★ P : Plug, B : Bottom

Tapping Speeds

List No. 995, 996

Viper Taflet Thread Forming Taps

Work Materials	Tapping Speed SFM
Structural Steels/Carbon Steels	30 - 50
Alloy Steels (20-30 HRC)	20 - 30
Stainless Steel	10 - 15

HIGH PERFORMANCE TAPS

VTP Tap Spiral Fluted



Modified Bottoming Style 2-1/2 To 3 Thread Lead
Surface Treated

List No. 980 Metric Sizes

VANADIUM HIGH SPEED STEEL HSSE-V

*Replacing VIPER T Series

Nominal Size (mm)	Pitch (mm)	E.D.P. Number					No. Of Flutes	Dimensions		
		D3	D4	D5	D6	D7		Overall Length	Length of Thread	Shank Dia.
M3	0.5	54615	—	—	—	—	3	1 15/16	0.236	0.141
M3.5	0.6	—	54616	—	—	—		2	0.276	0.168
M4	0.7	—	54617	—	—	—		2 1/8	0.354	0.194
M5	0.8	—	54619	—	—	—		2 3/8	0.433	0.255
M6	1	—	—	54620	—	—		2 1/2	0.472	0.318
M7	1	—	—	54621	—	—		2 23/32	0.551	0.381
M8	1	—	—	54622	—	—				
	1.25	—	—	54623	—	—		2 15/16	0.630	0.367
M10	1.25	—	—	54624	—	—				
	1.5	—	—	—	54625	—		3 3/8	0.551	0.429
M12	1.25	—	—	54626	—	—				
	1.75	—	—	—	54627	—		3 19/32	0.709	0.480
M14	1.5	—	—	—	54628	—				
	2	—	—	—	—	54629		3 13/16	0.551	0.542
M16	1.5	—	—	—	54630	—				
	2	—	—	—	—	54631		4 1/32	0.874	0.542
M18	1.5	—	—	—	54632	—				
	2.5	—	—	—	—	54633				

Order by EDP Number

VTP Tap Spiral Pointed



Plug Style, 4 To 5 Thread Lead
Surface Treated

List No. 982 Metric Sizes

VANADIUM HIGH SPEED STEEL HSSE-V

*Replacing VIPER T Series

Nominal Size (mm)	Pitch (mm)	E.D.P. Number					No. Of Flutes	Dimensions		
		D3	D4	D5	D6	D7		Overall Length	Length of Thread	Shank Dia.
M3	0.5	52615	—	—	—	—	3	1 15/16	0.394	0.141
M3.5	0.6	—	52616	—	—	—		2	0.433	0.168
M4	0.7	—	52617	—	—	—		2 1/8	0.551	0.194
M5	0.8	—	52619	—	—	—		2 3/8	0.591	0.255
M6	1	—	—	52620	—	—		2 1/2	0.669	0.318
M7	1	—	—	52621	—	—		2 23/32	0.748	0.381
M8	1	—	—	52622	—	—				
	1.25	—	—	52623	—	—		2 15/16	0.984	0.367
M10	1.25	—	—	52624	—	—				
	1.5	—	—	—	52625	—		3 3/8	1.102	0.480
M12	1.25	—	—	52626	—	—				
	1.75	—	—	—	52627	—		3 19/32	0.551	0.542
M14	1.5	—	—	—	52628	—				
	2	—	—	—	—	52629		3 13/16	1.102	0.542
M16	1.5	—	—	—	52630	—				
	2	—	—	—	—	52631		4 1/32	0.542	0.542
M18	1.5	—	—	—	52632	—				
	2.5	—	—	—	—	52633				

Order by EDP Number

VTP Spiral Fluted



Modified Bottoming Style 2-1/2 To 3 Thread Lead
Surface Treated

List No. 983 Machine Screw Sizes

List No. 981 Fractional Sizes

VANADIUM HIGH SPEED STEEL HSSE-V

*Replacing VIPER T Series

Nominal Size	Thread/Inch		E.D.P. Numbers						No. of Flutes	Dimensions		
	NC UNC	NF UNF	H2	H3	H4	H5	H6	H7		Overall Length	Length of Thread	Shank Dia.
MACHINE SCREW SIZES - L983												
2	56		88239	—	—	—	—	—	2	1 3/4	0.433	0.141
3	48		88240	—	—	—	—	—		1 13/16	0.500	
4	40	48	88241	88242	88243	—	—	—	3	1 7/8	0.236	
			88245	—	—	—	—	1 15/16				
5	40		88253	—	—	—	—	—	3	2	0.276	0.168
6	32	40	—	88263	88264	88265	88266	88267		2 1/8		
8	32		—	88277	88278	88279	88280	88281	3	2 3/8	0.354	0.194
10	24	32	—	88291	—	88292	88293	88294				
			—	88299	88300	88301	—	88303				
12	24	28	—	88311	—	—	—	—	3	2 3/8	0.354	0.220
			—	88312	—	—	—	—				
FRACTIONAL - L981												
1/4	20		—	88057	—	88060	—	88062	3	2 1/2	0.433	0.255
		28	—	88071	88072	88073	88074	88075				
5/16	18		—	88081	—	88083	—	88085		2 23/32	0.472	0.318
		24	—	88095	88096	88097	—	88098				
3/8	16		—	88103	—	88105	—	88107		2 15/16	0.551	0.381
		24	—	88111	88112	88113	—	88115				
7/16	14		—	88117	—	88119	—	—		3 5/32	0.591	0.323
		20	—	88123	—	88125	—	—				
1/2	13		—	88131	—	88133	—	88135		3 3/8	0.630	0.367
		20	—	88139	—	88141	—	—				
9/16	12		—	88145	—	—	—	—		3 19/32	0.709	0.429
		18	—	88146	—	—	—	—				
5/8	11		—	88149	—	88151	—	88153		3 13/16	0.748	0.480
		18	—	88157	—	88159	—	—				
3/4	10		—	88167	—	—	—	88171		4 1/4	0.827	0.590
		16	—	88175	—	88177	—	—				
7/8	9		—	88180	—	—	—	—	4 11/16	0.906	0.697	
		14	—	88185	—	—	—	—				
1	8		—	88190	—	—	—	—	4	5 1/8	0.984	0.800
		12	—	—	88192	—	—	—				

Order by EDP Number

HIGH PERFORMANCE TAPS

VTP Spiral Pointed



Plug Style 4 to 5 Threads
Surface Treated

List No. 973 Machine Screw Sizes

List No. 971 Fractional Sizes

VANADIUM HIGH SPEED STEEL HSSE-V

*Replacing VIPER T Series

Nominal Size	Thread/Inch		E.D.P. Numbers						No. of Flutes	Dimensions		
	NC UNC	NF UNF	H2	H3	H4	H5	H6	H7		Overall Length	Length of Thread	Shank Dia.
MACHINE SCREW SIZES - L973												
2	56		87216	87218	—	—	—	—	2	1 3/4	0.437	0.141
3	48		87220	—	—	—	—	1 13/16		0.500		
4	40		87240	87242	87243	87244	—	—		1 7/8	0.354	
		48	87245	—	—	—	—	—		1 15/16	0.394	
5	40		87252	—	—	—	—	—		2	0.433	
6	32		87258	87260	87261	87264	87265	87266	3	2 3/8	0.551	0.194
		40	87269	—	—	—	—	—				
8	32		87272	87274	87275	87278	87279	87280				
10	24		—	87288	—	87290	—	—	3	2 3/8	0.500	0.220
		32	87294	87296	87297	87300	87301	87302				
12	24		—	87311	—	—	—	—				
		28	—	87312	—	—	—	—				
FRACTIONAL SIZES - L971												
1/4	20		87052	87056	—	87060	—	87062	3	2 1/2	0.591	0.255
		28	87066	87068	87070	87071	87072	87073				
5/16	18		—	87080	—	87084	—	87086		2 23/32	0.669	0.318
		24	—	87094	87096	87097	87098	87099				
3/8	16		—	87102	—	87104	—	87106		2 15/16	0.748	0.381
		24	—	87110	87112	87113	87114	87115				
7/16	14		—	87116	—	87120	—	—		3 5/32	0.866	0.323
		20	—	87122	—	87126	87127	87129				
1/2	13		—	87130	—	87134	—	87136		3 3/8	0.984	0.367
		20	—	87138	—	87140	87141	87142				
9/16	12		—	87143	—	—	—	—		3 19/32	1.102	0.480
		18	—	87144	—	—	—	—				
5/8	11		—	87148	—	87152	—	87154		3 13/16	1.181	0.590
		18	—	87158	—	87159	—	—				
3/4	10		—	87164	—	—	—	87167		4 1/4	1.299	0.697
		16	—	87168	—	87169	—	—				
7/8	9		—	87170	—	—	—	—	4 11/16	1.378	0.800	
		14	—	87171	—	—	—	—				
1	8		—	87172	—	—	—	—	5 1/8	—	—	
		12	—	—	87176	—	—	—				

Order by EDP Number

VTP Series Tapping Speeds

SFM: Surface Feet per Minutes

VTP Spiral Flute TAP List 980, 983, 981

Work Materials	Tapping Speed SFM
Low Carbon Steel	1010,1018 30-60
Medium Carbon Steel	1035,1045 15-40
High Carbon Steel	1065,1095 15-25
Alloy Steel	4140,4130 15-40
Die Steels	D2,H13 10-25
Hardened Die Steels (20-40HRC)	D2,H13 6-12
Stainless steel (Austenitic)	303,304,316 10-25
Stainless steel (Martensitic)	410,430 10-25
Stainless steel (PH) up to 35HRC	17-4PH 8-15
Titanium Alloy Up to 32HRC	6AL4V 10-15
Magnesium Alloy	30-60
Ductile Cast Irons	80-55-06 15-40
Cast Irons	Nodular,Grey -
Copper	15-40
Brass, Brass Casting	40-60
Bronze, Brass Casting	25-50

Thread Depth	Coefficient
Up to 1.5D	1
1.5D~2.5D	0.9
2.5D~3D	0.8
Over 3D	0.7

1. These are general tapping conditions, may be altered by your condition.
2. These conditions are for tapping depth 1.5D. In case of deeper thread you may multiply these values by the coefficient of next table

SFM: Surface Feet per Minutes

VTP Spiral Point TAP List 982, 973, 971

Work Materials	Tapping Speed SFM
Low Carbon Steel	1010,1018 35-75
Medium Carbon Steel	1035,1045 20-50
High Carbon Steel	1065,1095 15-30
Alloy Steel	4140,4130 20-50
Die Steels	D2,H13 15-30
Hardened Die Steels (20-40HRC)	D2,H13 38-15
Stainless steel (Austenitic)	303,304,316 15-35
Stainless steel (Martensitic)	410,430 15-35
Stainless steel (PH) up to 35HRC	17-4PH 10-20
Titanium Alloy Up to 32HRC	6AL4V 15-20
Magnesium Alloy	40-80
Ductile Cast Irons	80-55-06 20-50
Cast Irons	Nodular,Grey 30-60
Copper	20-50
Brass, Brass Casting	50-80
Bronze, Brass Casting	30-60

1. These are general tapping conditions, may be altered by your condition.
2. These conditions are for tapping depth 1.5D. In case of deeper thread you may multiply these values by the coefficient of next table

Standard Hand Tap



Bright Finish

List No. 911 Fractional Sizes
HIGH SPEED STEEL

Size	Thread			Pitch Diameter Limits	E.D.P.			Number of Flutes	Dimensions											
	UNC	UNF	UNS		Taper	Plug	Bottom		Overall Length	Thread Length	Shank Dia.									
					L911	L911	L911													
1/4	20			H2	64059	64060	64061	4	2 1/2	1	0.255									
	20			H3	64068	64069	64070													
	20			H5	64075	64076	64076													
		28		H3	64089	64090	64091													
		28		H4		64093	64094													
5/16	18			H2	64098	64099	64100		4	2 23/32	1 1/8	0.318								
	18			H3	64107	64108	64109													
	18			H5		64111	64112													
		24		H3	64122	64123	64124													
		24		H4		64126	64127													
3/8	16			H2	64131	64132	64133			4	2 15/16	1 1/4	0.381							
	16			H3	64137	64138	64139													
	16			H5		64141	64142													
		24		H3	64152	64153	64154													
		24		H4		64156	64157													
7/16	14			H3	64167	64168	64169	4			3 5/32	1 7/16	0.323							
		20		H3	64182	64183	64184													
				H3	64197	64198	64199													
1/2	13			H3	64197	64198	64199				4	3 3/8	1 21/32	0.367						
	13			H5		64201	64202													
		20		H3	64212	64213	64214													
		20		H5		64216	64217													
9/16	12			H3	64221	64222	64223		4			3 19/32			1 13/16	0.480				
		18		H3	64230	64231	64232													
				H3	64242	64243	64244													
5/8	11			H5		64246	64247			4		3 13/16	1 13/16	0.480						
	11			H3	64254	64255	64256													
		18		H5		64258	64259													
11/16			11	H3	64260	64261	64262					4			4 1/32	1 13/16	0.542			
			16	H3	64263	64264	64265													
				H3	64272	64273	64274													
3/4	10			H3	64272	64273	64274	4					4 1/4	2	0.590					
	10			H5		64276	64277													
		16		H3	64284	64285	64286													
7/8				H5		64288	64289				4		4 11/16			2 7/32	0.697			
	9			H4	64293	64294	64295													
		14		H4	64302	64303	64304													
1	8			H4	64311	64312	64313		4				5 1/8	2 1/2	0.800					
		12		H4	64314	64315	64316													
			14	H4	64320	64321	64322													
1 1/8	7			H4	64323	64324	64325			4			5 7/16			2 9/16	0.896			
		12		H4	64326	64327	64328													
1 1/4	7			H4	64329	64330	64331						4					5 3/4	2 9/16	1.021
		12		H4	64332	64333	64334													
1 3/8	6			H4	64335	64336	64337					4		6 1/16	3			1.108		
		12		H4	64338	64339	64340													
1 1/2	6			H4	64341	64342	64343	4						6 3/8		3	1.233			
				H4	64344	64345	64346													
		12		H4	64344	64345	64346													

Order by EDP Number

TAPS

Standard Hand Tap



Bright Finish

List No. 913 Machine Screw Size
HIGH SPEED STEEL

Nominal Tap Size	Threads		Pitch Diameter Limits	E.D.P. Numbers			Number of Flutes	Dimensions		
	NC UNC	NF UNF		Taper	Plug	Bottom		Overall Length	Thread Length	Shank Dia.
				L913	L913	L913				
0		80	H1	64360	64361	64362	2	1 5/8	5/16	0.141
		80	H2		64364	64365				
1	64	64	H1	64366	64367	64368	3	1 11/16	3/8	
			H2		64370					
	H1	64372	64373	64374						
	H2		64376	64377						
2	56	56	H1	64381	64382	64383	3	1 3/4	7/16	
			H2	64387	64388	64389				
	H1	64390	64391	64392						
	H2	64393	64394	64395						
3	48	48	H1		64397		3	1 13/16	1/2	
			H2	64402	64403	64404				
	H1		64406							
	H2	64408	64409	64410						
4	36NS	40	H2	64411	64412	64413	3	1 7/8	9/16	
			H1	64417	64418	64419				
	H2	64423	64424	64425						
	H1		64427							
5	40	40	H1		64430	64431	3	1 15/16	5/8	
			H2	64438	64439	64440				
	H1		64442	64443						
	H2	64447	64448	64449						
6	32	32	H2	64459	64460	64461	3	2	11/16	
			H3	64465	64466	64467				
	H7		64469	64470						
	H1		64472							
8	32	32	H2	64477	64478	64479	4	2 1/8	3/4	
			H3	64495	64496	64497				
	H7	64504	64505	64506						
	H1		64508	64509						
10	36	36	H1		64515		4	2 3/8	7/8	
			H2	64517	64518	64519				
	H2	64532	64533	64534						
	H3	64541	64542	64543						
	H7		64548	64549						
	H2	64562	64563	64564						
12	24	24	H3	64571	64572	64573	4	15/16	0.220	
			H7		64578	64579				
	H3	64583	64584	64585						
	H3	64589	64590	64591						

Order by EDP Number

TAPS

Standard Tap Spiral Pointed



Plug Style, Bright Finish

List No. 921 Fractional Sizes

HIGH SPEED STEEL

Nominal Tap Size	Threads per inch		Pitch Diameter Limits	E.D.P. Numbers	Number of Flutes	Dimensions		
	NC UNC	NF UNF				Overall Length	Thread Length	Shank Dia.
1/4	20		H3	67054	2	2 1/2	1	0.255
	20		H3	67056	3			
		28	H3	67068	2			
5/16	18		H3	67078	2	2 23/32	1 1/8	0.318
	18		H3	67080	3			
		24	H3	67092	2			
3/8	16		H2	67100	3	2 15/16	1 1/4	0.381
	16		H3	67102				
	16		H5	67104				
7/16		24	H3	67110	3	3 5/32	1 7/16	0.323
	14		H3	67116				
		20	H3	67122				
1/2		20	H3	67130	3	3 3/8	1 21/32	0.367
	13		H3	67138				
		20	H3	67142				
9/16	12		H3	67148	3	3 19/32	1 21/32	0.429
5/8	11		H3	67148	3	3 13/16	1 13/16	0.480
3/4	10		H3	67150	4	4 1/4	2	0.590

Order by EDP Number

Standard Hand Tap for Cast Iron



Surface Treated

List No. 969 Fractional Sizes

HIGH SPEED STEEL

Size	Threads		Thread Limits	E.D.P.		Number of Flutes	Dimensions		
	UNC	UNF		Plug	Bottom		Overall Length	Thread Length	Shank Dia.
1/4	20		H3	76001	76002	4	2 1/2	1	0.255
	20		H5	76003	76004				
		28	H3	76005	76006				
5/16	18		H3	76007	76008	4	2 23/32	1 1/8	0.318
	18		H5	76009	76010				
		24	H3	76011	76012				
3/8	16		H3	76013	76014	4	2 15/16	1 1/4	0.381
	16		H5	76015	76016				
		24	H3	76017	76018				
7/16	14		H3	76019	76020	4	3 5/32	1 7/16	0.323
	14		H5	76021	76022				
		20	H3	76023	76024				
1/2		20	H5	76025	76026	4	3 3/8	1 21/32	0.367
	13		H3	76027	76028				
	13		H5	76029	76030				
9/16		20	H3	76031	76032	4	3 19/32	1 21/32	0.429
		20	H5	76033	76034				
	12		H3	76035	76036				
5/8		18	H3	76037	76038	4	3 13/16	1 13/16	0.480
	11		H3	76039	76040				
		18	H3	76041	76042				
3/4		16	H3	76043	76044	4	4 1/4	2	0.590
	10		H3	76045	76046				
		16	H3	76045	76046				

Order by EDP Number

Standard Tap Spiral Pointed



Plug Style
Bright Finish

List No. 923 Machine Screw Sizes
HIGH SPEED STEEL

Nominal Tap Size	Threads per inch		Pitch Diameter Limits	E.D.P. Numbers	Number of Flutes	Dimensions		
	NC UNC	NF UNF		Plug L923		Overall Length	Thread Length	Shank Dia.
0		80	H1	67200		1 5/8	5/16	
			H2	67202				
1	64		H1	67206	2	1 11/16	3/8	
			H2	67208				
	72	H1	67210					
		H2	67212					
2	56		H1	67214	2	1 3/4	7/16	
			H2	67216				
	64	H2	67224					
3	48		H2	67228	2	1 13/16	1/2	
			H2	67234				
4	36NS		H2	67236	2	1 7/8	9/16	0.141
	40		H1	67238				
			H2	67240				
	48		H2	67248				
5	40		H1	67250	2	1 15/16	5/8	
			H2	67252				
	44	H2	67254					
6	32		H2	67258	2	2	11/16	
			H3	67260				
	40	H7	67264					
		H2	67268					
8	32		H2	67272	2	2 1/8	3/4	0.168
			H3	67274				
	36	H7	67278					
		H2	67282					
10	24		H2	67286	2	2 3/8	7/8	0.194
			H3	67288				
			H7	67290				
	32	H2	67294					
		H3	67296					
	H7	67300						
12	24		H3	67304			15/16	0.220

Order by EDP Number

TAPS

Standard Hand Tap



Bright Finish

List No. 910 Metric Sizes

HIGH SPEED STEEL

Nominal Tap Size (mm)	Millimeter Pitch (mm)	Pitch Dia. Limits	E.D.P. Numbers			Number of Flutes	Dimensions		
			Taper	Plug	Bottom		Overall Length	Thread Length	Shank Dia.
M2	0.4	D3	54056	54057	54058	3	1 3/4	7/16	0.141
M3	0.5		54071	54072	54073		1 15/16	5/8	
M3.5	0.6		54074	54075	54076		2	11/16	
M4	0.7	D4	54080	54081	54082	4	2 1/8	3/4	0.168
M5	0.8		54095	54096	54097		2 3/8	7/8	0.194
M6	1.0	D5	54107	54108	54109	4	2 1/2	1	0.255
M7	1.0		54113	54114	54115		2 23/32	1 1/8	0.318
M8	1.25	D6	54125	54126	54127	4	2 15/16	1 1/4	0.381
M10	1.5		54140	54141	54142		3 3/8		0.367
M12	1.75	D5	54155	54156	54157	4	3 19/32	1 21/32	0.429
M14	1.25		54161	54162	54163		3 13/16		0.480
M14	2.0	D7	54167	54168	54169	4	4 1/32	1 13/16	0.542
M16	2.0		54176	54177	54178		4 15/32	2	0.652
M18	1.5	D8	54182	54183	54184	4	4 11/16	2 7/32	0.697
M18	2.5		54188	54189	54190		4 29/32		0.760
M20	2.5	D9	54200	54201	54202	4	5 1/8	2 1/2	0.896
M22	2.5		54212	54213	54214		5 7/16	2 9/16	1.021
M24	3.0	D8	54224	54225	54226	4			
M27	3.0		54239	54240	54241				
M30	3.5	D9	54251	54252	54253	4			

Order by EDP Number

Standard Tap Spiral Pointed



Bright Finish

List No. 920 Metric Sizes

HIGH SPEED STEEL

Nominal Tap Size (mm)	Pitch (mm)	Pitch Diameter Limits	E.D.P. Numbers	Number of Flutes	Dimensions		
					Overall Length	Thread Length	Shank Dia.
M2.5	0.45	D3	57054	2	1 13/16	1/2	0.141
M3	0.50		57055		1 15/16	5/8	
M4	0.70		57058		2 1/8	3/4	
M5	0.80	D4	57061	2	2 3/8	7/8	0.194
M6	1.00		57063		2 1/2	1	0.255
M8	1.25	D5	57068	2	2 23/32	1 1/8	0.318
M10	1.50		57082		2 15/16	1 1/4	0.381
M12	1.75	D6	57073	3	3 3/8	1 21/32	0.367
M14	2.00		57076		3 19/32		0.429
M16	2.00	D7	57078	3	3 13/16	1 13/16	0.480

Order by EDP Number

Taper Pipe Tap Straight Fluted



Bright Finish

List No. 941 (NPT)

List No. 941D (NPTF) Dry Seal

Nominal Tap Size	Threads per Inch	E.D.P. Number		Number of Flutes	Dimensions				
		L941 NPT	L941D NPTF		Overall Length	Thread Length	Shank Dia.	Square Length	Size of Square
1/16	27	74051	74062	4	2.126	0.6890	0.3125	0.374	0.2339
1/8		74052	74063			0.7520	0.4375		0.3280
1/8SS		74053	74064			0.3125	0.2339		
1/4	18	74054	74065		2.437	1.0630	0.5625	0.437	0.4209
3/8		74055	74066		2.563		0.7000	0.500	0.5307
1/2	14	74056	74067		3.126	1.3740	0.6875	0.626	0.5150
3/4		74057	74068	3.252	0.9063		0.689	0.6787	
1		74058	74069	3.752	1.1250		0.811	0.8429	
1 1/4	11 1/2	74059	74070	4.000	1.7520	1.3125	0.937	0.9839	
1 1/2		74060	74071	4.252		1.5000	1.000	1.1248	
2		74061	74072	4.500		1.8750	1.126	1.4059	

Order by EDP Number

Taper Pipe Tap Interrupted



Bright Finish

List No. 943 (NPT)

List No. 943D (NPTF) Dry Seal

Nominal Tap Size	Thread Per Inch	E.D.P. Numbers		Number of Flutes	Dimensions				
		L943 NPT	L943D NPTF		Overall Length	Thread Length	Shank Dia.	Square Length	Size of Square
1/8	27	74073	74173	5	2.126	0.752	0.4375	0.374	0.3280
1/4	18	74075	74175		2.437	1.063	0.5625	0.437	0.4209
3/8		74076	74176		2.563	0.7000	0.500	0.5307	
1/2		74077	74177		3.126	1.374	0.6875	0.626	0.5150
3/4	14	74078	74178		3.252	0.9063	0.689	0.6787	
1		11 1/2	74079		74179	3.752	1.752	1.1250	0.811

Order by EDP Number

TAPS

Taper Pipe Tap Spiral Fluted



Surface Treated

List No. 947 (NPT)

List No. 947D (NPTF) Dry Seal

PREMIUM TYPE STEEL

Nominal Tap Size	Thread Per Inch	E.D.P. Numbers		Number of Flutes	Dimensions				
		L947 NPT	L947D NPTF		Overall Length	Thread Length	Shank Dia.	Square Length	Size of Square
1/16	27	84051	84062	4	2.126	0.689	0.3125	0.374	0.2339
1/8		84052	84063			0.752	0.3280		
1/8SS		84053	84064			0.3125	0.2339		
1/4	18	84054	84065	4	2.437	1.063	0.5625	0.437	0.4209
3/8		84055	84066			2.563	0.7000	0.500	0.5307
1/2	14	84056	84067	5	3.126	1.374	0.6875	0.626	0.5150
3/4		84057	84068			3.252	0.9063	0.689	0.6787
1		11 1/2	84058			84069	3.752	1.752	1.1250

Order by EDP Number

Straight Pipe Tap Straight Fluted



Bright Finish

List No. 945 (NPS)

List No. 945D (NPSF) Dry Seal

HIGH SPEED STEEL

Nominal Tap Size	Threads per Inch	E.D.P. Numbers		Number of Flutes	Dimensions								
		L941 NPS	L941D NPSF		Overall Length	Thread Length	Shank Dia.	Square Length	Size of Square				
1/8	27	74083	74090	4	2.126	0.752	0.4375	0.374	0.3280				
1/4	18	74085	74092							1.063	0.5625	0.437	0.4209
3/8		74086	74093							2.563	0.7000	0.500	0.5307
1/2	14	74087	74094	5	3.126	1.374	0.6875	0.626	0.5150				
3/4		74088	74095							3.252	0.9063	0.689	0.6787
1		11 1/2	74089								3.752	1.752	1.1250

Order by EDP Number

Taper Pipe Tap Short Projection



Bright Finish

List No. 959 (NPT)

List No. 959D (NPTF) Dry Seal

HIGH SPEED STEEL

Nominal Tap Size	Thread Per Inch	E.D.P. Numbers		Number of Flutes	Dimensions					
		L959 NPT	L959D NPTF		Projection*	Overall Length	Thread Length	Shank Dia.	Square Length	Size of Square
1/8	27	74100	74107	4	.241	2.126	0.752	0.4375	0.374	0.3280
1/4	18	74102	74109		.361	2.437	1.063	0.5625	0.437	0.4209
3/8		74103	74110		2.563	0.7000	0.500	0.5307		
1/2	14	74104	74111	5	.464	3.126	1.374	0.6875	0.626	0.5150
3/4		74105	74112		3.252	0.9063	0.689	0.6787		
1	11 1/2	74106	74113	.565	3.752	1.752	1.1250	0.811	0.8429	

Order by EDP Number

* Projection Tolerance: 1/8" - 3/4" ± 1/16"
1" ± 3/32"

Taper Pipe Tap 6" Extension



Bright Finish

List No. 957 (NPT)

HIGH SPEED STEEL

Nominal Tap Size	Threads per Inch	E.D.P. Numbers	Number of Flutes	Dimensions				
				Overall Length	Thread Length	Shank Dia.	Square Length	Size of Square
1/16	27	74120	4	6	0.689	0.3125	0.374	0.2339
1/8		74121			0.752	0.4375		
1/4	18	74123			1.063	0.5625	0.437	0.4209
3/8		74124	0.7000		0.500	0.5307		
1/2	14	74125	5		1.374	0.6875	0.626	0.5150
3/4		74126			0.9063	0.689	0.6787	
1	11 1/2	74127	1.752	1.1250	0.811	0.8429		

Order by EDP Number

TAPS

Tapping Speeds

Standard Taps

Material	Tapping Speed SFM
Aluminum Alloys	90-100
Brass	60-100
Bronze	40-60
Copper	40-60
High Temperature Alloys	Cobalt Base 5-10 Iron Base 10-15 Nickel Base 5-10
Iron, Ductile	Annealed 60 as Cast 30 Tempered 15-20
Gray	Annealed 80 as Cast 35-60
Malleable	60 Heat Treated 25-50
Magnesium Alloys	Annealed 175
Manganese	20
Molybdenum Alloys	Stress Relieved 50
Monel	Annealed 20
Nickel Alloys	Annealed 25
Plastics, Reinforced	25
Thermoplastics	50
Thermosetting Plastics	50
Steels, Alloys, Annealed or Cold Drawn	40-60
Quenched & Tempered	15-35
Armor Plate	10

Material	Tapping Speed SFM
(Steels Cont.)	
Carbon Steel, Plain	Annealed 40-80 Tempered 15-40
Cast Carbon	Annealed 40-50 Tempered 30
Cast, Corrosion Resistant	Annealed 20-30 as Cast 20-25
Heat Resistant	Annealed 30-45 Tempered 15-25
Low Alloy	Treated 10-15 Annealed 15-45
Precipitation Hardening	15-75
Stainless	Annealed 45-75 Tempered 15-25
Free Machining	Annealed 15-25
Tool Steels, High Speed	Annealed 50
Water Hardening	Annealed 35
Ultra High Strength Steels	Annealed 20 Normalized 3-7 Tempered 20-15
Maraging Steels	Annealed 5-10 Maraged 3
Tantalum Alloys	Stress Relieved 3
Titanium Alloys	
Commercial Pure	Annealed 40-60
Alpha & Alpha Beta Alloys	Annealed 10-25
Tungsten Alloys, Pressed & Sintered	50
Zinc Alloys	Die Cast 150

CONVERSION TABLE

Surface Feet Per Minute to Revolutions Per Minute

SFM	20	25	30	40	50	60	70	80	90	100	110	120	130	140	150
TAP SIZE	REVOLUTIONS PER MINUTE														
0	1270	1590	1910	2540	3100	3850	4450	5100	5750	6350	7000	7650	8200	8900	9550
1	1040	1310	1550	2100	2600	3140	3650	4150	4710	5200	5750	6250	6800	7300	7850
2	850	1100	1300	1750	2250	2650	3100	3550	4000	4450	4850	5350	5750	6200	6650
3	750	950	1150	1550	1900	2300	2700	3050	3450	3850	4250	4600	5000	5400	5750
4	650	850	1050	1350	1700	2050	2300	2700	3050	3400	3750	4100	4450	4750	5100
5	600	750	900	1200	1550	1850	2100	2400	2750	3100	3350	3650	3950	4250	4550
6	550	650	850	1100	1350	1650	1950	2200	2450	2750	3050	3300	3600	3850	4150
8	450	580	700	950	1150	1400	1650	1850	2100	2350	2550	2800	3000	3250	3500
10	400	500	600	800	1005	1200	1400	1600	1800	2000	2200	2400	2600	2800	3000
12	350	450	550	700	850	1050	1250	1400	1550	1750	1950	2100	2300	2450	2650
1/4	300	380	450	600	750	900	1050	1200	1350	1500	1650	1800	1950	2150	2300
5/16	250	300	350	480	600	750	850	950	1100	1250	1350	1450	1550	1700	1850
3/8	200	250	300	400	500	600	700	800	900	1000	1100	1200	1300	1400	1500
7/16	170	210	250	350	450	520	600	700	750	850	950	1050	1150	1250	1300
1/2	150	190	220	300	350	450	530	600	650	750	850	900	950	1050	1150
9/16	130	170	200	250	350	400	450	550	600	650	750	800	900	950	1050
5/8	120	150	180	250	300	350	400	450	550	600	650	750	800	850	900
3/4	100	120	150	200	250	300	350	400	450	500	550	600	650	700	750
7/8	80	100	130	170	200	250	300	350	400	450	480	520	550	600	650
1	70	90	100	150	190	230	260	300	350	380	420	450	500	530	570

The material being tapped is the primary factor in determining the most effective TAPPING SPEED. However there are a number of other factors which may require consideration. Among these are: thread pitch, thread length, percent of thread, lubrication, tap flute style and chamfer, equipment and method of tapping. The best speed is determined by experiment on the job. The table below lists speeds which have proven satisfactory under average conditions.

Standards & Dimensions

Standard System of Marking	
General	
Taps, dies, and other threading tools will be marked with the nominal size, number of threads per inch, and the proper symbol to identify the thread form. These symbols are in agreement with the ANSIB94.9 1979 Standard on Nomenclature, Definitions and Letter Symbols for Screw Threads.	
Symbols used for American Threads are: Symbol Reference	
NC	American National Coarse Thread Series
NF	American National Fine Thread Series
NEF	American National Extra Fine Thread Series
N	American National 8,12 and 16 Thread Series (8N, 12N, i6N)
NH	American (National) Hose Coupling and Fire Hose Coupling Threads
NM	National Miniature Screw Thread
NGO	American (National) Gas Outlet Thread
NS	American Special Thread
NPT	American (National) Taper Pipe Thread
NPTF	Dryseal American (National) Taper Pipe Thread
ANPT	Military Aeronautical Pipe Thread Specification MIL-P-71 05
NPS	American (National) Straight Pipe Thread
NPSC	American (National) Straight Pipe Thread in Pipe Couplings
NPSF	Dryseal American (National) Fuel Internal Straight Pipe Thread
NPSH	American (Standard) Straight Pipe Thread for Hose Couplings and Nipples
NPSI	Dryseal American (National) Intermediate Internal Straight Pipe Thread
NPSL	American (National) Internal Straight Pipe Thread for Locknut Connections (Loose Fitting Mechanical Joints)
NPSM	American (National) Internal Straight Pipe Thread for Mechanical Joints (Free Fitting)
NPTR	American (National) Internal Taper Pipe Thread for Railing Joints (Mechanical Joints)
AMO	American Standard Microscope Objective Thread
ACME C	Acme Screw Thread – Centralizing Type
ACME G	Acme Screw Thread – General Purpose Type
STUB ACME	Stub Acme Threads

NBUTT	National Buttress Screw Thread		
V	A 60° "V" Thread with Truncated Crests and Roots. The Theoretical "V" Form is usually flattened several thousandths of an inch to the user's specifications.		
SB	Manufacturers Stovebolt Standard Thread		
STI	Special Threads for Helical Coil Wire Screw Thread Inserts.		
Group Thread Taps - Limit Numbers			
All standard Ground Thread Taps will be marked with the letter G to designate Ground Thread. The letter G will be followed by the letter H to designate above basic (L below basic) and a numeral to designate the Pitch Diameter limits.			
Example: GH3 indicates a Group thread Tap with Pitch Diameter limits .0010 to .0015 over basic.			
Pitch Diameter limits for Taps to 1" diameter inclusive.			
	L1	= Basic to Basic minus .0005	
	H1	= Basic to Basic plus .0005	
	H2	= Basic plus .0005 to Basic plus .0010	
	H3	= Basic plus .0010 to Basic plus .0015	
	H4	= Basic plus .0015 to Basic plus .0020	
	H5	= Basic plus .0020 to Basic plus .0025	
	H6	= Basic plus .0025 to Basic plus .0030	
Pitch Diameter limits for Taps over 1" diameter to 1 1/2" diameter inclusive.			
	H4	= Basic plus .0010 to Basic plus .0020	
American National 8, 12, 16 and NEF Thread Series			
National 8 pitch Series	1" to 2 1/4"	by 1/8ths	
	2 1/4" to 6"	by 1/4ths	
National 12 pitch Series	1/2" to 1 1/2"	1/16ths	
	1 1/2" to 4"	by 1/8ths	
	4" to 6"	by 1/4ths	
National 16 pitch Series	3/4" to 2 1/2"	by 1/16ths	
	2 1/2" to 4"	by 1/8ths	
	4" to 6"	by 1/4ths	
National Extra Fine Thread Series			
#12	-32	1 1/6"	-18
1/4"	-32	1 1/16"	-18
5/16"	-32	1 1/18"	-18
3/8"	-32	1 3/16"	-18
7/16"	-28	1 1/4"	-18
1/2"	-28	1 5/16"	-18
9/16"	-24	1 3/8"	-18
5/8"	-24	1 7/16"	-18
11/16"	-24	1 1/2"	-18
3/4"	-20	1 9/16"	-18
13/16"	-20	1 5/8"	-18
7/8"	-20	1 11/16"	-18
15/16"	-20	1 3/4"	-16
1"	-20	2"	-16

TAPS-TECHNICAL

Standard Tap Blank Dimensions

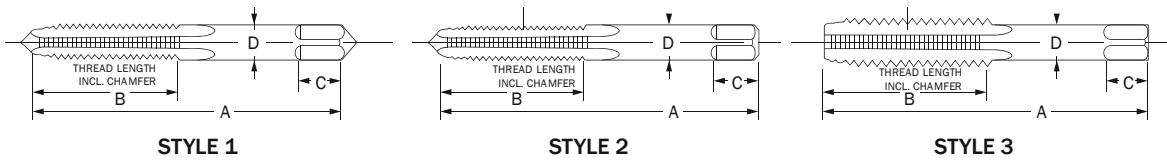

Table 302 - General Dimensions

Nominal Diameter Range - Inches		Machine Screw Size No.	Nominal Fractional Diameter Inches	Nominal Metric Diameter Mill.	Style*	Tap Dimensions — Inches				
Over	To (Incl)					Overall Length A	Thread Length B	Square Length C	Shank Diameter D	Size of Square
.052	.065	0	1/16	M1.6	1	1 5/8	5/16	3/16	.141	.110
.065	.078	1		M1.8	1	1 11/16	3/8	3/16	.141	.110
.078	.091	2		M2,MZ2	1	1 3/4	7/16	3/16	.141	.110
.091	.104	3	3/32	M2.5	1	1 13/16	1/2	3/16	.141	.110
.104	.117	4			1	1 7/8	9/16	3/16	.141	.110
.117	.130	5	1/8	M3, M3.15	1	1 15/16	5/8	3/16	.141	.110
.130	.145	6		M3.5	1	2	11/16	3/16	.141	.110
.145	.171	8	5/32	M4	1	2 1/8	3/4	1/4	.168	.131
.171	.197	10	3/16	M4.5, M5	1	2 3/8	7/8	1/4	.194	.152
.197	.223	12	7/32		1	2 3/8	15/16	9/32	.220	.165
.223	.260	14	1/4	M6, M6.3	2	2 1/2	1	5/16	.255	.191
.260	.323		5/16	M7, M8	2	2 23/32	1 1/8	3/8	.318	.238
.323	.385		3/8	M10	2	2 15/16	1 1/4	7/16	.381	.286
.385	.448		7/16		3	3 5/32	1 7/16	13/32	.323	.242
.448	.510		1/2	M12 M12.5	3	3 3/8	1 21/32	7/16	.367	.275
.510	.573		9/16	M14	3	3 19/32	1 21/32	1/2	.429	.322
.573	.635		5/8	M16	3	3 13/16	1 13/16	9/16	.480	.360
.635	.709		11/16	M18	3	4 1/32	1 13/16	5/8	.542	.406
.709	.760		3/4		3	4 1/4	2	11/16	.590	.442
.760	.823		13/16	M20	3	4 15/32	2	11/16	.652	.489
.823	.885		7/8	M22	3	4 11/16	2 7/32	3/4	.697	.523
.885	.948		15/16	M24	3	4 29/32	2 7/32	3/4	.760	.570
.948	1.010	1		M25	3	5 1/8	2 1/2	13/16	.800	.600
1.010	1.073		1 1/16	M27	3	5 1/8	2 1/2	7/8	.896	.672
1.073	1.135		1 1/8		3	5 7/16	2 9/16	7/8	.896	.672
1.135	1.198		1 3/16	M30	3	5 7/16	2 9/16	1	1.021	.766
1.198	1.260		1 1/4		3	5 3/4	2 9/16	1	1.021	.766
1.260	1.323		1 5/16	M33	3	5 3/4	2 9/16	1 1/16	1.108	.831
1.323	1.385		1 3/8		3	6 1/16	3	1 1/16	1.108	.831
1.385	1.448		1 7/16	M36	3	6 1/16	3	1 1/8	1.233	.925
1.448	1.510		1 1/2		3	6 3/8	3	1 1/8	1.233	.925
1.510	1.635		1 5/8	M39	3	6 11/16	3 3/16	1 1/8	1.305	.979
1.635	1.760		1 3/4	M42	3	7	3 3/16	1 1/4	1.430	1.072
1.760	1.885		1 7/8		3	7 5/16	3 9/16	1 1/4	1.519	1.139
1.885	2.010	2		M48	3	7 5/8	3 9/16	1 3/8	1.644	1.233
2.010	2.135		2 1/8		3	8	3 9/16	1 3/8	1.769	1.327
2.135	2.260		2 1/4	M56	3	8 1/4	3 9/16	1 7/16	1.894	1.420
2.260	2.385		2 3/8		3	8 1/2	4	1 7/16	2.019	1.514
2.385	2.510		2 1/2		3	8 3/4	4	1 1/2	2.100	1.575
2.510	2.635		2 5/8	M64	3	8 3/4	4	1 1/2	2.225	1.669
2.635	2.760		2 3/4		3	9 1/4	4	1 9/16	2.350	1.762
2.760	2.885		2 7/8	M72	3	9 1/4	4	1 9/16	2.475	1.856
2.885	3.010	3			3	9 3/4	4 9/16	1 5/8	2.543	1.907
3.010	3.135		3 1/8		3	9 3/4	4 9/16	1 5/8	2.668	2.001
3.135	3.260		3 1/4	M80	3	10	4 9/16	1 3/4	2.793	2.095
3.260	3.385		3 3/8		3	10	4 9/16	1 3/4	2.883	2.162
3.385	3.510		3 1/2		3	10 1/4	4 15/16	2	3.008	2.256
3.510	3.635		3 5/8	M90	3	10 1/4	4 15/16	2	3.133	2.350
3.635	3.760		3 3/4		3	10 1/2	5 5/16	2 1/8	3.217	2.413
3.760	3.885		3 7/8		3	10 1/2	5 5/16	2 1/8	3.342	2.506
3.885	4.010	4		M100	3	10 3/4	5 5/16	2 1/4	3.467	2.600

* Styles shown are for ground thread taps

**Tap Recommendation for Classes 2B & 3B
Unified Inch Screw Threads**

Size	Threads Per Inch		Recommended Tap Limits		Internal Thread Pitch Diameter Units		
	NC UNC	NF UNF	Class 2B	Class 3B	Min. All Classes (BASIC)	Max. Class 2B	Max. Class 3B
0	-	80	H2	H1	.0519	.0542	.0536
1	64	-	H2	H1	.0629	.0655	.0648
1	-	72	H2	H1	.0640	.0665	.0659
2	56	-	H2	H1	.0744	.0772	.0765
2	-	64	H2	H1	.0759	.0786	.0779
3	48	-	H2	H1	.0855	.0885	.0877
3	-	56	H2	H1	.0874	.0902	.0895
4	40	-	H2	H2	.0958	.0991	.0982
4	-	48	H2	H1	.0985	.1016	.1008
5	40	-	H2	H2	.1088	.1121	.1113
5	-	44	H2	H1	.1102	.1134	.1126
6	32	-	H3	H2	.1177	.1214	.1204
6	-	40	H2	H2	.1218	.1252	.1243
8	32	-	H3	H2	.1437	.1475	.1465
8	-	36	H2	H2	.1460	.1496	.1487
10	24	-	H3	H3	.1629	.1672	.1661
10	-	32	H3	H2	.1697	.1736	.1726
12	24	-	H3	H3	.1889	.1933	.1922
12	-	28	H3	H3	.1928	.1970	.1959
1/4	20	-	H5	H3	.2175	.2223	.2211
1/4	-	28	H4	H3	.2268	.2311	.2300
5/16	18	-	H5	H3	.2764	.2817	.2803
5/16	-	24	H4	H3	.2854	.2902	.2890
3/8	16	-	H5	H3	.3344	.3401	.3387
3/8	-	24	H4	H3	.3479	.3528	.3516
7/16	14	-	H5	H3	.3911	.3972	.3957
7/16	-	20	H5	H3	.4050	.4104	.4091
1/2	13	-	H5	H3	.4500	.4565	.4548
1/2	-	20	H5	H3	.4675	.4731	.4717
9/16	12	-	H5	H3	.5084	.5152	.5135
9/16	-	18	H5	H3	.5264	.5323	.5308
5/8	11	-	H5	H3	.5660	.5732	.5714
5/8	-	18	H5	H3	.5889	.5949	.5934
3/4	10	-	H5	H5	.6850	.6927	.6907
3/4	-	16	H5	H3	.7094	.7159	.7143
7/8	9	-	H6	H4	.8028	.8110	.8089
7/8	-	14	H6	H4	.8286	.8356	.8339
1	8	-	H6	H4	.9188	.9276	.9254
1	-	12	H6	H4	.9459	.9535	.9516
1	14 NS		H6	H4	.9536	.9609	.9590
1 1/8	7	-	H8	H4	1.0332	1.0416	1.0393
1 1/8	-	12	H6	H4	1.0709	1.0787	1.0768
1 1/4	7	-	H8	H4	1.1572	1.1668	1.1644
1 1/4	-	12	H6	H4	1.1959	1.2039	1.2019
1 3/8	6	-	H8	H4	1.2667	1.2771	1.2745
1 3/8	-	12	H6	H4	1.3209	1.3291	1.3270
1 1/2	6	-	H8	H4	1.3917	1.4022	1.3996
1 1/2	-	12	H6	H4	1.4459	1.4542	1.4522

The above recommended taps normally produce the Class of Thread indicated average materials when used with reasonable care. However, if the tap specified does not give a satisfactory gauge fit in the work, a choice of some other limit tap will be necessary.

TAPS - TECHNICAL

Tap Drill Sizes

The following tables show the Theoretical Percentage of Thread obtained from stock sizes of drills and also the Probable Percentage after allowance for oversize drilling.

Tap	Tap Drill	Decimal Equiv. of Tap Drill	Probable Hole Size	Percent of Thread	Tap	Tap Drill	Decimal Equiv. of Tap Drill	Probable Hole Size	Percent of Thread	Tap	Tap Drill	Decimal Equiv. of Tap Drill	Probable Hole Size	Percent of Thread
0-80	56	.0465	.0480	74	8-32	29	.1360	.1389	62	3/8-16	5/16	.3125	.3160	72
	3/64	.0469	.0484	71		28	.1405	.1434	51		0	.3160	.3204	68
1-64	54	.0550	.0565	81	8-36	29	.1360	.1389	70	3/8-24	P	.3230	.3274	59
	53	.0595	.0610	59		28	.1405	.1434	57		21/64	.3281	.3325	79
1-72	53	.0595	.0610	67	10-24	9/64	.1406	.1435	57	7/16-14	Q	.3320	.3364	71
	1/16	.0625	.0640	50		27	.1440	.1472	79		R	.3390	.3434	58
2-56	51	.0670	.0687	74	10-32	26	.1470	.1502	74	7/16-20	T	.3580	.3626	81
	50	.0700	.0717	62		25	.1495	.1527	69		23/64	.3594	.3640	79
2-64	49	.0730	.0747	49	10-32	24	.1520	.1552	64	7/16-20	U	.3680	.3726	70
	50	.0700	.0717	70		23	.1540	.1572	61		3/18	.3750	.3796	62
3-48	49	.0730	.0747	56	10-32	5/32	.1563	.1595	56	7/16-20	V	.3770	.3816	60
	48	.0760	.0779	78		22	.1570	.1602	55		W	.3860	.3906	72
3-56	5/64	.0781	.0800	70	12-24	5/32	.1563	.1595	75	1/2-13	25/64	.3906	.3952	65
	47	.0785	.0804	69		22	.1570	.1602	73		X	.3970	.4016	55
4-40	46	.0810	.0829	60	12-24	21	.1590	.1622	68	1/2-20	27/64	.4219	.4216	73
	45	.0820	.0839	56		20	.1610	.1642	64		7/16	.4375	.4422	58
4-48	46	.0810	.0829	69	12-28	19	.1660	.1692	51	9/16-12	29/64	.4531	.4578	65
	45	.0820	.0839	65		11/64	.1719	.1754	75		15/32	.4688	.4736	82
5-40	44	.0860	.0879	48	12-28	17	.1730	.1765	73	9/16-18	31/64	.4844	.4892	68
	44	.0860	.0880	74		16	.1770	.1805	66		1/2	.5000	.5048	80
5-44	43	.0890	.0910	65	12-28	15	.1800	.1835	60	5/8-11	33/64	.5156	.5204	58
	42	.0935	.0955	55		14	.1820	.1855	56		17/32	.5313	.5362	75
5-48	3/32	.0938	.0958	50	1/4-20	16	.1770	.1805	77	5/8-18	35/64	.5469	.5518	62
	42	.0935	.0955	61		15	.1800	.1835	70		9/16	.5625	.5674	80
6-40	3/32	.0938	.0958	60	1/4-20	14	.1820	.1855	66	3/4-10	37/64	.5781	.5831	58
	41	.0960	.0980	52		13	.1850	.1885	59		41/64	.6406	.6456	80
6-44	40	.0980	.1003	76	1/4-20	3/16	.1875	.1910	54	3/4-16	21/32	.6563	.6613	68
	39	.0995	.1018	71		9	.1960	.1998	77		11/16	.6875	.6925	71
6-48	38	.1015	.1038	65	1/4-28	8	.1990	.2028	73	7/8-9	49/64	.7656	.7708	72
	37	.1040	.1063	58		7	.2010	.2048	70		25/32	.7812	.7864	61
7-40	38	.1015	.1038	72	1/4-28	13/64	.2031	.2069	66	7/8-14	51/64	.7969	.8021	79
	37	.1040	.1063	63		6	.2040	.2078	65		13/16	.8125	.8177	62
7-48	36	.1065	.1088	55	5/16-18	5	.2055	.2093	63	1*-8	55/64	.8594	.8653	83
	37	.1040	.1063	78		4	.2090	.2128	57		7/8	.8750	.8809	73
8-40	36	.1065	.1091	71	5/16-18	3	.2130	.2168	72	1*-12	57/64	.8906	.8965	64
	7/64	.1094	.1120	64		7/32	.2188	.2226	59		29/32	.9063	.9122	54
8-48	35	.1100	.1126	63	5/16-24	2	.2210	.2248	55	1*-14	29/32	.9063	.9123	81
	34	.1110	.1136	60		F	.2570	.2608	72		59/64	.9219	.9279	67
9-40	33	.1130	.1156	55	5/16-24	G	.2610	.2651	66	1*-14	15/16	.9375	.9435	52
	34	.1110	.1136	75		17/64	.2656	.2697	59		59/64	.9219	.9279	78
9-48	33	.1130	.1156	69	5/16-24	H	.2660	.2701	59	1*-14	15/16	.9375	.9435	61
	32	.1160	.1186	60		H	.2660	.2701	78					
						I	.2720	.2761	67					

Formula for Obtaining Tap Drill Sizes

(Select nearest commercial stock drill)

$$\text{Percent of Thread} = \frac{\text{Basic thread OD.} \times \text{Pre-Tapping Diameter}}{2 \times (\text{Basic Height of Thread})} \times 100\%$$

• **Pre-Tapping Diameter for Cutting Taps**

$$\text{Pre-tapping Diameter} = \text{Basic thread OD.} - \frac{.01299 \times \text{Percent of Thread}}{\text{No. of threads per inch}}$$

• **Pre-Tapping Diameter for Roll Forming Taps**

$$\text{Pre-tapping Diameter} = \text{Basic thread OD.} - \frac{.0068 \times \text{Percent of Thread}}{\text{No. of threads per inch}}$$

Tap Drill Sizes

For Thread Forming Taps

Nominal Size	Threads per Inch		75% Thread			70% Thread			65% Thread			60% Thread		
			Theor. Hole Core Size	Nearest Drill Size	Dec. Equiv.	Theor. Hole Core Size	Nearest Drill Size	Dec. Equiv.	Theor. Hole Core Size	Nearest Drill Size	Dec. Equiv.	Theor. Hole Core Size	Nearest Drill Size	Dec. Equiv.
	NC UNC	NF UNF												
0	—	80	.0536	1.35mm	.0531	.0540	1.35mm	.0531	.0545	—	—	.0549	54	.0550
1	64	—	.0650	1.65mm	.0650	.0655	1.65mm	.0650	.0661	—	—	.0666	—	—
1	—	72	.0659	1.65mm	.0650	.0663	—	—	.0669	1.7mm	.0669	.0673	51	.0670
2	56	—	.0769	1.95mm	.0768	.0774	1.95mm	.0768	.0781	3/64	.0781	.0787	47	.0785
2	—	64	.0780	5/64	.0781	.0785	47	.0785	.0791	2.0mm	.0787	.0796	2.0mm	.0787
3	48	—	.0884	2.25mm	.0886	.0890	43	.0890	.0898	43	.0890	.0905	2.3mm	.0906
3	—	56	.0899	43	.0890	.0904	—	—	.0911	2.3mm	.0906	.0917	2.3mm	.0906
4	40	—	.0993	2.5mm	.0984	.1000	39	.0995	.1010	39	.0995	.1018	38	.1015
4	—	48	.1014	38	.1015	.1020	38	.1015	.1028	2.6mm	.1024	.1035	2.6mm	.1024
5	40	—	.1123	34	.1110	.1130	33	.1130	.1140	33	.1130	.1148	2.9mm	.1142
5	—	44	.1134	33	.1130	.1141	2.9mm	.1142	.1150	2.9mm	.1142	.1157	—	—
6	32	—	.1221	2.1mm	.1220	.1230	3.1mm	.1220	.1243	—	—	.1252	1/8	.1250
6	—	40	.1253	1/8	.1250	.1260	3.2mm	.1260	.1270	3.2mm	.1260	.1278	3.25mm	.1280
8	32	—	.1481	3.75mm	.1476	.1490	—	—	.1503	25	.1495	.1512	3.8mm	.1496
8	—	36	.1498	25	.1495	.1507	3.8mm	.1496	.1518	24	.1520	.1526	24	.1520
10	24	—	.1688	—	—	.1700	18	.1695	.1717	11/64	.1719	.1729	11/64	.1719
10	—	32	.1741	17	.1730	.1750	—	—	.1763	—	—	.1772	16	.1770
12	24	—	.1948	10	.1935	.1960	9	.1960	.1977	5.0mm	.1968	.1989	8	.1990
12	—	28	.1978	5.0mm	.1968	.1989	8	.1990	.2003	8	.1990	.2014	7	.2010
1/4	20	—	.2245	5.7mm	.2244	.2260	—	—	.2280	1	.2280	.2295	1	.2280
1/4	—	28	.2318	—	—	.2329	5.9mm	.2323	.2343	A	.2340	.2354	15/64	.2344
5/16	18	—	.2842	7.2mm	.2835	.2861	7.25mm	.2854	.2879	7.3mm	.2874	.2898	L	.2900
5/16	—	24	.2912	7.4mm	.2913	.2927	—	—	.2941	M	.2950	.2955	7.5mm	.2953
3/8	16	—	.3431	11/32	.3437	.3452	8.75mm	.3445	.3474	S	.3480	.3495	8.9mm	.3504
3/8	—	24	.3537	9.0mm	.3543	.3552	9.0mm	.3543	.3566	—	—	.3580	T	.3580
7/16	14	—	.4011	—	—	.4035	Y	—	.4059	13/32	—	.4084	—	—
7/16	—	20	.4120	Z	—	.4137	10.5mm	—	.4154	—	—	.4171	—	—
1/2	13	—	.4608	—	—	.4634	—	—	.4660	—	—	.4686	15/32	—
1/2	—	20	.4745	—	—	.4762	—	—	.4779	—	—	.4796	—	—
9/16	12	—	.5200	—	—	.5229	—	—	.5257	—	—	.5285	—	—
9/16	—	18	.5342	13.5mm	.5315	.5361	—	—	.5380	—	—	.5398	—	—
5/8	11	—	.5787	37/64	.5781	.5817	37/64	.5781	.5848	—	—	.5879	—	—
5/8	—	18	.5967	19/32	.5937	.5986	—	—	.6004	—	—	.6023	—	—
3/4	10	—	.6990	—	—	.7024	—	—	.7058	45/64	.7031	.7092	18.0mm	.7087
3/4	—	16	.7181	23/32	.7187	.7202	23/32	.7187	.7224	—	—	.7245	—	—

Nom. Dia	Pitch	Theoretical Core Hole Size						Suggested	Taps
		Min.		Max.					
		Inches	mm	5H Class		6H Class			
				Inches	mm	Inches	mm		
3	0.5	.1071	2.72	.1094	2.79	.1098	2.79	H5	H6
3.5	0.6	.1244	3.16	.1268	3.22	.1276	3.24	H5	H7
4	0.7	.1417	3.60	.1445	3.67	.1453	3.69	H6	H7
5	0.8	.1791	4.55	.1823	4.63	.1831	4.65	H6	H8
6	1	.2142	5.44	.2177	5.53	.2185	5.55	H7	H9
8	1.25	.2870	7.29	.2913	7.40	.2925	7.43	H8	H10
10	1.5	.3602	9.15	.3602	9.27	.3665	9.31	H9	H11
12	1.75	.4335	11.01	.4368	11.14	.4402	11.18	H10	H12
14	2	.5067	12.87	.5126	13.02	.5142	13.06	H11	H13
16	2	.5854	14.87	.5913	15.02	.5929	15.06	H11	H13
20	2.5	.7315	18.58	.7386	18.76	.7409	18.82	H11	H14

TAPS-TECHNICAL

For Pipe Taps

Nominal Pipe Size	Threads Per Inch	NPT-NPTF (When Drilled Only)		NPT-NPTF-ANPT (When Taper Reamed)		NPS-NPSF	
		Dr. Size	Dec. Equiv.	Dr. Size	Dec. Equiv.	Dr. Size	Dec. Equiv.
1/16	27	D	.2460	15/64	.2344	1/4	.2500
1/8	27	R	.3390	21/64	.3281	11/32	.3438
1/4	18	7/16	.4375	27/64	.4219	7/16	.4375
3/8	18	37/64	.5781	9/16	.5625	37/64	.5781
1/2	14	45/64	.7031	11/16	.6875	23/32	.7188
3/4	14	59/64	.9219	57/64	.8906	59/64	.9218
1	11-1/2	1 5/32	1.1562	1 1/8	1.1250	1 5/32	1.1562
1 1/4	11-1/2	1 1/2	1.5000	1 15/32	1.4688		
1 1/2	11-1/2	1 47/64	1.7344	1 45/64	1.7031		
2	11-1/2	2 7/32	2.2188	2 3/16	2.1875		

Tap Drill Sizes (Metric)

For Cutting Taps

Unit : mm

Nominal Size	Pitch	Percentage of Thread Engagement Hole Diameter				Minor Dia. of Internal Thread
		100%	90%	80%	70%	
M2	0.4	1.57	1.61	1.65	1.70	1.567~1.679
M3	0.5	2.46	2.51	2.57	2.62	2.459~2.599
M3.5	0.6	2.85	2.92	2.98	3.05	2.850~3.010
M4	0.7	3.24	3.32	3.39	3.47	3.242~3.422
M5	0.8	4.13	4.22	4.31	4.39	4.134~4.334
M6	1	4.92	5.03	5.13	5.24	4.917~5.153
M7	1	5.92	6.03	6.13	6.24	5.917~6.153
M8	1.25	6.65	6.78	6.92	7.05	6.647~6.912
	1	6.92	7.03	7.13	7.24	6.917~7.153
M10	1.5	8.38	8.54	8.70	8.86	8.376~8.676
	1.25	8.65	8.78	8.92	9.05	8.647~8.912
M12	1.75	10.11	10.30	10.50	10.70	10.106~10.441
	1.25	10.65	10.78	10.92	11.05	10.647~10.912
M14	2	11.80	12.10	12.30	12.50	11.835~12.210
	1.25	12.65	12.78	12.92	13.05	12.647~19.912

Nominal Size	Pitch	Percentage of Thread Engagement Hole Diameter				Minor Dia. of Internal Thread
		100%	90%	80%	70%	
M16	2	13.80	14.10	14.30	14.50	13.835~14.210
	1.5	14.38	14.54	14.70	14.86	14.376~14.676
M18	2.5	15.30	15.60	15.80	16.10	15.294~15.744
	1.5	16.38	16.54	16.70	16.86	16.376~16.676
M20	2.5	17.30	17.60	17.80	18.10	17.294~17.744
	1.5	18.38	18.54	18.70	18.86	18.376~18.676
M22	2.5	19.30	19.60	19.80	20.10	19.264~19.744
	1.5	20.38	20.54	20.70	20.86	20.367~20.676
M24	3	20.80	21.10	21.40	21.70	20.752~21.252
	1.5	22.38	22.54	22.70	22.86	22.376~22.676
M27	3	23.80	24.10	24.40	24.70	23.752~24.252
M30	3.5	26.20	26.60	27.00	27.30	26.211~26.711

For Thread Forming Taps

Unit : mm

Nominal Size	Pitch	Percentage of Thread Engagement Hole Diameter			
		100%	90%	80%	70%
M2	0.4	1.77	1.80	1.82	1.84
M2.2	0.45	1.94	1.97	2.00	2.02
M2.5	0.45	2.24	2.27	2.30	2.32
M3	0.5	2.72	2.74	2.77	2.80
M3.5	0.6	3.16	3.19	3.23	3.26
M4	0.7	3.60	3.64	3.68	3.72
M4.5	0.75	4.07	4.12	4.16	4.20
M5	0.8	4.55	4.59	4.64	4.68
M6	1	5.43	5.49	5.55	5.60
M7	1	6.43	6.49	6.55	6.60
M8	1.25	7.29	7.36	7.43	7.50
	1	7.43	7.49	7.55	7.60

Nominal Size	Pitch	Percentage of Thread Engagement Hole Diameter			
		100%	90%	80%	70%
M10	1.5	9.15	9.23	9.32	9.40
	1.25	9.29	9.36	9.43	9.50
M12	1.75	11.01	11.11	11.21	11.31
	1.25	11.29	11.36	11.43	11.50
M14	2	12.87	12.98	13.09	13.21
	1.5	13.15	13.23	13.32	13.40
M16	2	14.87	14.98	15.09	15.21
	1.5	15.15	15.23	15.32	15.40
M18	2.5	16.58	16.72	16.87	17.01
	1.5	17.15	17.23	17.32	17.40
M20	2.5	18.58	18.72	18.87	19.01
	1.5	19.15	19.23	19.32	19.40

Note:

1. Determine hole diameter by tapping test. The dimensions in this table are for reference only.

Tap Tolerance Table

GT Limits Table

Fractional, Machine screw, and Metric Taps
Over 42 TPI, or less than 0.6mm pitch

Class	MIN	MAX
GT2	0.0002	0.0008
GT3	0.0006	0.0012
GT4	0.0010	0.0016
GT5	0.0014	0.0020
GT6	0.0018	0.0024
GT7	0.0022	0.0028

Fractional, Machine Screw, and Metric Taps
Less than 42 TPI, or over 0.6mm pitch

Class	MIN	MAX
GT2	0.0000	0.0008
GT3	0.0004	0.0012
GT4	0.0008	0.0016
GT5	0.0012	0.0020
GT6	0.0016	0.0024
GT7	0.0020	0.0028
GT8	0.0024	0.0031
GT9	0.0028	0.0035
GT10	0.0031	0.0039

GT Limits Conversion Chart

Recommended tap limits for 2B and 3B

TAP SIZE	CLASS 2B		CLASS 3B	
	H LIMITS	GT LIMITS	H LIMITS	GT LIMITS
2-56	H2	GT3	H1	-
2-64	H2	GT3	H1	-
3-48	H2	GT4	H1	-
3-56	H2	GT3	H1	-
4-40	H2	GT5	H2	-
4-48	H2	GT4	H1	-
5-40	H2	GT5	H2	-
5-44	H2	GT5	H2	-
6-32	H3	GT5	H2	-
6-40	H2	GT5	H2	-
8-32	H3	GT5	H2	-
8-36	H2	GT5	H2	-
10-24	H3	GT6	H3	-
10-32	H3	GT5	H2	-
12-24	H3	GT6	H3	-
12-28	H3	GT6	H3	-
1/4-20	H5	GT7	H3	GT4
1/4-28	H4	GT6	H3	GT4
5/16-18	H5	GT7	H3	GT4
5/16-24	H4	GT7	H3	GT4
3/8-16	H5	GT8	H3	GT4
3/8-24	H4	GT7	H3	GT4
7/16-14	H5	GT8	H3	GT4
7/16-20	H5	GT8	H3	GT4
1/2-13	H5	GT8	H3	GT4
1/2-20	H5	GT8	H3	GT4
9/16-12	H5	GT8	H3	GT4
9/16-18	H5	GT8	H3	GT4
5/8-11	H5	GT9	H3	GT4
5/8-18	H5	GT8	H3	GT4
3/4-10	H5	GT9	H5	GT4
3/4-16	H5	GT8	H3	GT4
7/8-9	H6	GT9	H4	GT5
7/8-14	H6	GT9	H4	GT5
1-8	H6	GT9	H4	GT5
1-12	H6	GT9	H4	GT5

Tap Tolerance Table

H Limits Table

Fractional and Machine Screw Types

Class	MIN	MAX
H1	0.0000	0.0005
H2	0.0005	0.0010
H3	0.0010	0.0015
H4	0.0015	0.0020
H5	0.0020	0.0025
H6	0.0025	0.0030
H7	0.0030	0.0035
H8	0.0035	0.0040
H9	0.0040	0.0045
H10	0.0045	0.0050
H11	0.0050	0.0055
H12	0.0055	0.0060

D Limits Table

Metric Taps

Tap Size	D Class	MIN	MAX
M2X0.4	D3	0.0009	0.0015
M2.5X0.45	D3	0.0009	0.0015
M3X0.5	D3	0.0009	0.0015
M3.5X0.6	D4	0.0012	0.0020
M4X0.7	D4	0.0012	0.0020
M5X0.8	D4	0.0012	0.0020
M6X1	D5	0.0015	0.0025
M7X1	D5	0.0015	0.0025
M8X1	D5	0.0015	0.0025
M8X1.25	D5	0.0015	0.0025
M10X1.25	D5	0.0015	0.0025
M10X1.5	D6	0.0018	0.0030
M12X1.25	D5	0.0015	0.0025
M12X1.75	D6	0.0018	0.0030
M14X1.5	D6	0.0018	0.0030
M14X2	D7	0.0019	0.0035
M16X1.5	D6	0.0018	0.0030
M16X2.0	D7	0.0019	0.0035
M18X1.50	D6	0.0018	0.0030
M18X2.5	D7	0.0019	0.0035
M20X2.5	D7	0.0019	0.0035
M22X2.5	D7	0.0019	0.0035
M24X3.0	D8	0.0024	0.0040
M27X3.0	D8	0.0024	0.0040
M30X3.5	D9	0.0025	0.0045

SGSP/SGPO Tap Drill Size Recommendations

*Recommend using SG-ESS, AQRVDS, or AQRVDOH3D as Tap Drill

Tap Size	Theoretical Hole Size % Thread (Inch)					Class 2B Fit (Inch)			Class 3B Fit (Inch)		
	80%	75%	70%	65%	60%	Minor Dia. Min.	Minor Dia. Max.	Recommended Drill	Minor Dia. Min.	Minor Dia. Max.	Recommended Drill
2-56	0.0674	0.0686	0.0698	0.0709	0.0721	0.0667	0.0737	#50 (0.070)	0.0667	0.0737	#50 (0.070)
4-40	0.0860	0.0876	0.0893	0.0909	0.0925	0.0849	0.0939	#43 (0.089)	0.0849	0.0939	#43 (0.089)
6-32	0.1055	0.1076	0.1096	0.1116	0.1136	0.1040	0.1140	#35 (0.110)	0.1040	0.1140	#35 (0.110)
8-32	0.1315	0.1336	0.1356	0.1376	0.1396	0.1300	0.1390	#29 (0.136)	0.1300	0.1389	#29 (0.136)
10-24	0.1467	0.1494	0.1521	0.1548	0.1575	0.1450	0.1560	#24 (0.152)	0.1450	0.1560	#24 (0.152)
10-32	0.1575	0.1596	0.1616	0.1636	0.1656	0.1560	0.1640	#20 (0.161)	0.1560	0.1641	#20 (0.161)
12-24	0.1727	0.1754	0.1781	0.1808	0.1835	0.1710	0.1810	#16 (0.177)	0.1710	0.1810	#16 (0.177)
1/4 - 20	0.1980	0.2013	0.2045	0.2078	0.2110	0.1960	0.2070	13/64 (0.2031)	0.1960	0.2067	13/64 (0.2031)
1/4 - 28	0.2129	0.2152	0.2175	0.2198	0.2222	0.2110	0.2200	5.5mm (0.2165)	0.2110	0.2190	5.5mm (0.2165)
5/16 - 18	0.2548	0.2584	0.2620	0.2656	0.2692	0.2520	0.2650	G (0.261)	0.2520	0.2630	F (0.257)
5/16 - 24	0.2692	0.2719	0.2746	0.2773	0.2800	0.2670	0.2770	I (0.272)	0.2670	0.2754	I (0.272)
3/8 - 16	0.3101	0.3141	0.3182	0.3222	0.3263	0.3070	0.3210	O (0.316)	0.3070	0.3182	5/16 (0.3125)
3/8 - 24	0.3317	0.3344	0.3371	0.3398	0.3425	0.3300	0.3400	Q (0.332)	0.3300	0.3372	Q (0.332)
7/16 - 14	0.3633	0.3679	0.3726	0.3772	0.3818	0.3600	0.3760	U (0.368)	0.3600	0.3717	U (0.368)
7/16 - 20	0.3855	0.3888	0.3920	0.3953	0.3985	0.3830	0.3950	25/64 (0.3906)	0.3830	0.3916	W (0.386)
1/2 - 13	0.4201	0.4251	0.4301	0.4351	0.4400	0.4170	0.4340	27/64 (0.4219)	0.4170	0.4284	27/64 (0.4219)
1/2 - 20	0.4480	0.4513	0.4545	0.4578	0.4610	0.4460	0.4570	29/64 (0.4531)	0.4460	0.4537	11.4mm (0.4488)
5/8 - 11	0.5305	0.5364	0.5423	0.5482	0.5541	0.5270	0.5460	17/32 (0.5312)	0.5270	0.5391	17/32 (0.5312)
5/8 - 18	0.5673	0.5709	0.5745	0.5781	0.5817	0.5650	0.5780	14.5mm (0.5709)	0.5650	0.5730	14.5mm (0.5709)
3/4 - 10	0.6461	0.6526	0.6591	0.6656	0.6721	0.6420	0.6630	21/32 (0.6562)	0.6420	0.6545	16.5mm (0.6496)
3/4 - 16	0.6851	0.6891	0.6932	0.6972	0.7013	0.6820	0.6960	11/16 (0.6875)	0.6820	0.6908	11/16 (0.6875)
1 - 8	0.8701	0.8782	0.8863	0.8945	0.9026	0.8650	0.8900	7/8 (0.875)	0.8650	0.8797	7/8 (0.875)
Tap Size	Theoretical Hole Size % Thread (Inch)					Class 6H Fit (Inch)					
	80%	75%	70%	65%	60%	Minor Dia. Min.	Minor Dia. Max.	Recommended Drill			
M3 X 0.5	0.0976	0.0988	0.1004	0.1016	0.1028	0.0968	0.1023	#39 (0.0995)			
M4 X 0.7	0.1287	0.1307	0.1323	0.1343	0.1358	0.1276	0.1347	3.3mm (0.1299)			
M5 X 0.8	0.1642	0.1661	0.1681	0.1701	0.1724	0.1628	0.1706	#19 (0.1660)			
M6 X 1.0	0.1953	0.1980	0.2004	0.2031	0.2055	0.1936	0.2029	5.0mm (0.1969)			
M8 X 1.25	0.2638	0.2669	0.2701	0.2732	0.2768	0.2617	0.2721	H (0.2660)			
M10 X 1.25	0.3425	0.3457	0.3488	0.3520	0.3555	0.3404	0.3509	8.8mm (0.3465)			
M10 X 1.5	0.3323	0.3362	0.3402	0.3437	0.3476	0.3298	0.3416	8.5mm (0.3346)			
M12 X 1.25	0.4213	0.4244	0.4276	0.4307	0.4343	0.4192	0.4296	10.8mm (0.4252)			
M12 X 1.5	0.4110	0.4150	0.4189	0.4224	0.4264	0.4085	0.4203	10.6mm (0.4173)			
M12 X 1.75	0.4008	0.4055	0.4098	0.4142	0.4189	0.3979	0.4111	13/32 (0.4063)			
M14 X 2.0	0.4693	0.4744	0.4795	0.4846	0.4898	0.4659	0.4807	12.2mm (0.4803)			
M16 X 2.0	0.5480	0.5531	0.5583	0.5634	0.5685	0.5447	0.5594	14.2mm (0.5591)			
M20 X 2.5	0.6850	0.6913	0.6980	0.7043	0.7106	0.6809	0.6986	17.7mm (0.6969)			
M24 X 3.0	0.8220	0.8299	0.8374	0.8453	0.8528	0.8170	0.8367	21.2mm (0.8346)			

Suggested Percentage of Full Thread in Tapped Holes

	Material	Deep Hole Tapping	Average Commercial Work	Thin Sheet Stock or Stamping
Free Cutting	Aluminum, Brass, Bronze, Cast Iron, Copper, Mild Steel, Tool Steel	60%-70%	65%-70%	75%-85%
Hard or Tough Cutting	Cast Steel, Drop Forging, Monel Metal, Nickel Steel, Stainless Steel	55%-65%	60%-70%	

TAPS - TECHNICAL

Classes and Tap Recommendations

Tap Size	Basic Pitch Diameter	Class 2B		Class 3B	
	All Classes Min.	Pitch Diameter Limits Max	Recommended Tap	Pitch Diameter Limits Max	Recommended Tap
2-56	0.0744	0.0772	H2	0.0765	H2
4-40	0.0958	0.0991	H2	0.0982	H2
6-32	0.1177	0.1214	H3	0.1204	H2
8-32	0.1437	0.1475	H3	0.1465	H2
10-24	0.1629	0.1672	H3	0.1661	H3
10-32	0.1697	0.1736	H3	0.1726	H2
12-24	0.1889	0.1933	H3	0.1922	H3
1/4 - 20	0.2175	0.2224	H5	0.2211	H3
1/4 - 28	0.2268	0.2311	H4	0.2300	H3
5/16 - 18	0.2764	0.2817	H5	0.2803	H3
5/16 - 24	0.2854	0.2902	H4	0.2890	H3
3/8 - 16	0.3344	0.3401	H5	0.3387	H3
3/8 - 24	0.3479	0.3528	H4	0.3516	H3
7/16 - 14	0.3911	0.3972	H5	0.3957	H3
7/16 - 20	0.4050	0.4104	H5	0.4091	H3
1/2 - 13	0.4500	0.4565	H5	0.4548	H3
1/2 - 20	0.4675	0.4731	H5	0.4717	H3
5/8 - 11	0.5660	0.5732	H6	0.5714	H4
5/8 - 18	0.5889	0.5949	H6	0.5934	H4
3/4 - 10	0.6850	0.6927	H6	0.6907	H4
3/4 - 16	0.7094	0.7159	H6	0.7143	H4
1 - 8	0.9188	0.9276	H6	0.9254	H4

Tap Size	Pitch Diameter Limits - Class 6H		Class 6H
	Maximum	Minimum	Recommended Tap
M3 x 0.5	0.1054	0.1092	D3
M4 x 0.7	0.1396	0.1442	D4
M5 x 0.8	0.1764	0.1812	D4
M6 x 1.0	0.2107	0.2165	D5
M8 x 1.25	0.2830	0.2892	D5
M10 x 1.25	0.3617	0.3680	D5
M10 x 1.5	0.3554	0.3624	D6
M12 x 1.25	0.4405	0.4476	D6
M12 x 1.5	0.4341	0.4416	D6
M12 x 1.75	0.4277	0.4355	D6
M14 x 2.0	0.5001	0.5083	D7
M16 x 2.0	0.5788	0.5871	D7
M20 x 2.5	0.7235	0.7322	D7
M24 x 3.0	0.8682	0.8785	D8

H2 = Basic P.D. + .0005" to Basic P.D. + .0010"
 H3 = Basic P.D. + .0010" to Basic P.D. + .0015"
 H4 = Basic P.D. + .0015" to Basic P.D. + .0020"
 H5 = Basic P.D. + .0020" to Basic P.D. + .0025"
 H6 = Basic P.D. + .0025" to Basic P.D. + .0030"

D3 = Basic P.D. + .0009" to Basic P.D. + .0015"
 D4 = Basic P.D. + .0012" to Basic P.D. + .0020"
 D5 = Basic P.D. + .0015" to Basic P.D. + .0025"
 D6 = Basic P.D. + .0018" to Basic P.D. + .0030"
 D7 = Basic P.D. + .0019" to Basic P.D. + .0035"
 D8 = Basic P.D. + .0024" to Basic P.D. + .0040"

The above recommended taps normally produce the class of thread indicated in average materials when used with reasonable care. However, if the tap specified does not give a satisfactory gage fit in the work, a choice of some other limit tap may be necessary.

Trouble-Shooting Guide for Tapping Problems

	Troubles	Factors	Countermeasures
Surface Roughness	Torn or Rough Thread	Chamfer length too short	• Increase chamfer length
		Wrong cutting angle	• Apply proper cutting angle
		Galling	<ul style="list-style-type: none"> • Use thread relieved taps • Reduce land width • Apply surface treatment such as steam oxide or chrome • Use proper cutting lubricant • Reduce tapping speed • Use larger drill size • Obtain proper alignment between tap and work
		Chip Packing	<ul style="list-style-type: none"> • Use spiral pointed or spiral fluted taps • Use larger drill size
	Chattering on Tapped Thread	Tool Free Cutting	<ul style="list-style-type: none"> • Avoid too narrow land width • Reduce amount of thread relief
		Tool Condition	<ul style="list-style-type: none"> • Reduce cuffing angle • Do not grind the bottom of the flute
Dimensional Error	Oversize Pitch Diameter	Incorrect Taps	<ul style="list-style-type: none"> • Use proper GH limits • Use longer chamfered taps
		Chip Packing	<ul style="list-style-type: none"> • Use spiral point or spiral fluted taps • Reduce number of flutes to provide extra chip room • Use National fine pitch, if applicable • Use larger drill size • If tapping a blind hole, allow deeper hole where applicable or shorten the thread length of the parts • Use proper lubricant
		Galling	<ul style="list-style-type: none"> • Apply proper surface treatment such as steamoxide • Use proper cutting lubricant • Reduce tapping speed • Use proper cutting angle in accordance with material being tapped. • Use larger drill size
		Operating Conditions	<ul style="list-style-type: none"> • Apply proper tapping speed • Correct alignment of tap and drill hole • Free cutting either tap or workpiece • Use proper tapping speed to avoid torn or rough thread • Use lead screw tapper • Use proper tapping machine with suitable power • Avoid misalignment of tap and drill hole from loose spindle or worn holder
		Tool Conditions	<ul style="list-style-type: none"> • Obtain proper indexing angle for the flutes at the cutting edge • Grind proper indexing angle and chamfer angle • Avoid too narrow land width • Remove burrs from reground edge
	Oversize Internal Diameter	Drill Hole Size	<ul style="list-style-type: none"> • Use minimum size drill hole • Avoid tapered hole • Use proper chamfered taps
		Galling	• Galling solutions 1 through 4 above can be applied to this specific problem

TAPS- TECHNICAL

	Troubles	Factors	Countermeasures
Dimensional Error	Undersize Pitch Diameter	Incorrect Tap Selection	<ul style="list-style-type: none"> • Use one oversize taps <ol style="list-style-type: none"> 1) Use for cuffing materials such as copper alloy, aluminum alloy, and cast iron 2) Use for cuffing tubing which will have “spring back” action after tapping • Apply proper chamfer angle • Increase cutting angle
		Damaged Thread	<ul style="list-style-type: none"> • Use proper reversing speed to avoid damaging tapped thread on the way out of the hole
		Left over Chips	<ul style="list-style-type: none"> • Increase cutting performance to avoid any leftover chip in the hole • Remove leftover chip from the hole for gauge checking
	Undersize Internal Diameter	Drill Hole size	<ul style="list-style-type: none"> • Use maximum drill size
Tool Life	Breakage	Incorrect Tap Selection	<ul style="list-style-type: none"> • Use high speed steel taps • Avoid chip packing in the flutes or the bottom of hole • Use spiral pointed or spiral fluted taps or Roll Taps • Apply correct surface treatment such as steam oxide or other coating
		Excessive Tapping Torque	<ul style="list-style-type: none"> • Use larger drill size • Try to shorten thread length • Apply National Fine Pitch if applicable • Increase cutting angle • Apply a tap with more thread relief and reduced land width • Use spiral pointed or spiral fluted taps
		Operating Conditions	<ul style="list-style-type: none"> • Reduce tapping speed • Avoid misalignment between tap and the hole and tapered hole • Use floating type of tapping holder • Use tapping holder with torque adjustment • Avoid hitting bottom of the hole with tap
		Tool Condition	<ul style="list-style-type: none"> • Do not grind the bottom of the flutes • Avoid too narrow a land width • Do not leave sections on the reground flutes which tapping wear still remains • Regrind tool more frequently
	Chipping	Incorrect Tap Selection	<ul style="list-style-type: none"> • Reduce cutting angle • Use a different kind of high speed steel taps • Reduce hardness of the taps • Increase chamfer length • Avoid chip packing in the flutes or the bottom of the hole by using spiral pointed or fluted taps
		Operating Conditions	<ul style="list-style-type: none"> • Reduce tapping speed • Avoid misalignment between tap and hole • Avoid sudden return or reverse in blind hole tapping • Avoid galling • Use larger drill size
	Wear	Incorrect Tap Selection	<ul style="list-style-type: none"> • Apply specially designed taps for tapping heat treated material • Change to a type of high speed steel material contained vanadium • Apply special surface treatment such as nitriding or TiN • Increase chamfer length
		Operating Conditions	<ul style="list-style-type: none"> • Reduce tapping speed • Apply proper cutting lubricants • Avoid work hardened hole • Use larger drill size
		Tool Condition	<ul style="list-style-type: none"> • Grind proper cutting angle • Avoid hardness reduction from grind process

MATERIAL SYMBOL CHART BY STANDARD

Description	U.S.A.		Japan	Germany	ISO
	ASTM	AISI	JIS	DIN	
General Structural Steel	C		SM490A SM490B SM570 SS400 SS330	St33	
	A				
	B				
	C				
	30				
	33				
	36				
	40				
	70		SS490	St52-3	
	C		SS540		
D		SM490A			
E		SM490B			
A		SM490C			
B		SM490Y			
50W		SM520			
A		SV330	Ust36		
B		SV400			
Carbon Steel		1015	S15C	CK15 C15	C15E4
		1025	S25C	CK25 C25	C25 C25E4
		1045	S45C	CK45 C45	C45 C45E4
		1046		C45	
		1050	S50C	CK50 C50	C50 C50E4
	60		SB410	H@ P7	P7 P28
65		SB450	17Mn4	P11 P28	
A		SB450M			
70		SB480			
B		SB480M			
Alloy Steel			SCM415 SCM415H SCM415TK SCM418 SCM418H SCM418TK SCM420 SCM420H SCM420TK SCM421 SCM430 SCM430TK SCM432 SCM435		18CrMo4 18CrMo4
		4130			
	4135			34CrMo4	34CrMo4
	4137				
	4135H		SCM435H	34CrMo4	34CrMo4
	4137H				
			SCM435TK	42CrMo4	
	4140				
	4142				
	4140H		SCM440H	42CrMo4	42CrMo4
	4142H				
			SCM440TK SCM445		
	4145				
	4147				
	4145H		SCM445H		
	4147H		SCM822 SCM822H SCr415 SCr415H SCr420 SCr420H SCr420TK SCr430		16MnCr5 16MnCr5 16MnCr5 16MnCr5
	5130			34Cr4	34Cr4
	5132				
	5130H		SCr430H	34Cr4	34Cr4
	5132H				
5135		SCr435	34Cr4 37Cr4	34Cr4 37Cr4	
			34Cr4 37Cr4	34Cr4 37Cr4	
5135H		SCr435H	37Cr4 41Cr4	37Cr4 41Cr4	
5140		SCr440	37Cr4 41Cr4	37Cr4 41Cr4	
			37Cr4 41Cr4	37Cr4 41Cr4	
5140H		SCr440H			
		SCr445			
5147		SMn420		22Mn6	
1522		SMn420H		22Mn6	
1522H		SMn433			
		SMn433H		36Mn6	
1541H		SMn438		36Mn6	
1541		SMn438H		36Mn6	
1541H					

Description	U.S.A.		Japan	Germany	ISO
	ASTM	AISI	JIS	DIN	
Alloy Steel		1541H	SMn443 SMn443H SNC326 SNC415 SNC415H SNC631 SNC631H SNC815 SNC815H SNC836 SNCM220		42Mn6
		8615			15NiCr13
		8617			20NiCrMo2
		8620			
		8622	SNCM220H		20NiCrMo2
		8617H			
		8620H			
		8622H			
		8637	SNCM240		41CrNiMo2
		8640			
	4320	SNCM415 SNCM420 SNCM420H SNCM431 SNCM439 SNCM447 SNCM616 SNCM625 SNCM630 SNCM815			
	4320H				
	4340				
Carbon Tool Steel	W1-111/2		SK1		TC140
	W1-10		SK2		TC120
	W1-9		SK3	C105W1	TC105
	W1-8		SK4		TC90
			SK5	C80W1 C80W1	TC90 TC80 TC70
			SK6		
			SK7		
			SKS2	C70W2 105WCr6	105WCr1
			SKS3		
			SKS4		
		SKS5			
		SKS6			
		SKS7			
		SKS8			
		SKS11			
		SKS21			
		SKS31	105WCr6	105WCr1	
		SKS41			
		SKS43			
		SKS44			
		SKS51			
		SKS93			
		SKS94			
		SKS95			
		SUJ2	100Cr6	1	
	52100				
Die Steel	D2		SKD11		
	H13		SKD61	X40CrMoV51	40CrMoV5
Tool Steel			SKT3		
			SKT4	55NiCrMoV6	55NiCrMoV2
Pipe Steel	TypeF		STAM290GB	St28	
	1008		SGP	St33	
	A		STKM11A	St34-2	
			STPT370	St35.8	
			STB340	St35.8 St37.8 St37.0	
	E-A		STPG370		
	A				
	B		STS370	St37.4	
	C		STPT410	St42.8	
A-1		STB410	St42.8		
E-B			St45.8		
B		STPG410	St44.0		
			St44.0		
		STK400	St44.2	TS9	
		STKM12B	St44.2		
		STKR400	St44.2		
		STAM390G	St44.2		
		STS410	St44.4		
		STKM14A	St45		
		STKM13C	St45		
		STKM18C	St52		
		STKM19A	St52		
		STKM19C	St52		
		STK490	St52-3	TS18	
		STKR490	St52-3		
	1020				

REFERENCE

MATERIAL SYMBOL CHART BY STANDARD

Description	U.S.A.		Japan	Germany	ISO
	ASTM	AISI	JIS	DIN	
Pipe Steel	1026 1025 1026		STS480 STKM12A STKM12C STKM13B STKM14B	St52.4	R33
	1050		STKM14C STKM15A STKM15C STKM16A STKM16C STKM17A STKM17C STKM18A STKM18B STKM20A		R50
Heat Resistant Steel	S65007		SUH1 SUH3 SUH4 SUH11 SUH21 SUH31 SUH35 SUH36 SUH37 SUH38 SUH309 SUH310 SUH330 SUH409 SUH409L SUH446 SUH600 SUH616 SUH660 SUH661		
	S63008 S63017 S30900 S31000 N08330 S40900 S44600 S42200 S66286 R30155			X6CrTi12	1T1 H7
Free Cutting Steel		1110 1108 1212 1213 1215 12L14 1117 1137 1141 1144	SUM11 SUM12 SUM21 SUM22 SUM22L SUM23 SUM23L SUM24L SUM25 SUM31 SUM31L SUM32 SUM41 SUM42 SUM43	9SMn28 9SMnPb28 9SMnPb28 9SMn36 15S10	9S20 11SMn28 11SMnPb 11SMnPb28 12SMn35 44SMn28
	Spring Steel	1075 1078 9260 5155 5160 6150 51B60 4161	SUP3 SUP6 SUP7 SUP9 SUP9A SUP10 SUP11A SUP12 SUP13		55Cr3 50CrV4 54SiCr6
Stainless Steel	S30400 S40500 S42020 S43000 S44002 S17400 S17700 S41000		SUS304 SUS405 SUS420F SUS430 SUS440A SUS630 SUS631 SUS410	X5CrNi1810 X6CrAl13 X6Cr17 X7CrNiAl177 X10Cr13	11 2 8 1 2 3
	Cast Steel	HT	SCH15		
Cast Iron	40 45		FC250 FC300		
Ductile Cast Iron	60-40-18 80-55-06		FCD400 FCD600	GGG-60	
Aluminum Alloy			A1080 A1070 A1050 A1100 A1200 A2014 A2017 A2017 A2024BD A2024BE A2024 P	Al99.8 Al99.7 Al99.5 Al99 AlCuSiMn AlCuMg1 AlCuSiMn AlCuMg2 AlCuMg2 EN AW-2024	Al99.5 Al99.0Cu Al99.0 Al-Cu4SiMg Al-Cu4MgSi Al-Cu4SiMg AlCu4Mg1 AlCu4Mg1 AlCu4Mg1
	1100 2014 2014 2024 2024 2024				

Description	U.S.A.		Japan	Germany	ISO
	ASTM	AISI	JIS	DIN	
Aluminum Alloy	2024 2024 2024 2024 3003 5052 5052		A2024 S A2024 TD A2024 TE A2024 W A3003 A5052 BD A5052 BE A5052 FH A5052 P A5052 S A5052 TD A5052 TE A5052 W A5056 A5083 A6061 A6063 A7075 BD A7075 BE A7075 FD A7075 FH A7075 P A7075 S A7075 TD A7075 TE	AlCuMg2 AlCuMg2 AlCuMg2 AlCuMg2 AlMg2.5 EN AW-5052 AlMg2.5 AlMg5 AlMg4.5Mn AlZnMgCu1.5 AlZnMgCu1.5 AlZnMgCu1.5 AlZnMgCu1.5 EN AW-7075 AlZnMgCu1.5 AlZnMgCu1.5 AlZnMgCu1.5	AlCu4Mg1 AlCu4Mg1 AlCu4Mg1 AlMg2.5 AlMg2.5 AlMg2.5 AlMg2.5 AlMg4.5Mn0.7 Al-Mg1SiCu Al-Mg0.7Si AlZn5.5MgCu AlZn5.5MgCu AlZn5.5MgCu AlZn5.5MgCu
	5083 6061 6063 7075 7075 7075 7075 7075 7075 7075 7075 7075		5083 6061 6063 7075 7075 7075 7075 7075 7075 7075 7075 7075	AC1A AC1B AC2A AC2B AC3A AC4A AC4B AC4C AC4CH AC4D AC5A AC7A AC7B AC8A AC8B AC8C AC9A AC9B ADC1 ADC3 ADC5 ADC6 ADC10 ADC10Z ADC12 ADC12Z ADC14	Al-Cu4MgTi Al-Si5Cu3 Al-Si6Cu4 Al-Si2 Al-Si10Mg Al-Si7Mg Al-Si7Mg Al-Si5Cu1Mg Al-Cu4Ni2Mg2 Al-Mg10 Al-Si2CuFe Al-Si9Cu3Fe
Aluminum Alloy Casting	295.0 204.0 319.0 333.0 356.0 A356.0 355.0 242.0 514.0 520.0 336.0 332.0 A413.0 A360.0 518.0 A380.0 A380.0 383.0 383.0 A390.0		G(GK)-AlCu4Ti G(GK)-AlCu4TiMg G(GK)AlSi2 G(GK)-AlSi10Mg G(GK)-AlSiCu3 G(GK)AlSi7Mg G(GK)-AlMg5 GD-AlSi12(Cu) GD-AlSi10Mg GD-AlMg9 ADC6 ADC10 ADC10Z ADC12 ADC12Z ADC14		Al-Cu4MgTi Al-Si5Cu3 Al-Si6Cu4 Al-Si2 Al-Si10Mg Al-Si7Mg Al-Si7Mg Al-Si5Cu1Mg Al-Cu4Ni2Mg2 Al-Mg10 Al-Si2CuFe Al-Si9Cu3Fe
	Magnesium Alloy	AZ91A AZ91B AZ91D AZ60A AZ60B AZ41A AZ80A AM20A AM50A AM60B AS22A AS41B AE42A		MD1A MD1B MD1D MB3 MD2B	DG-MgAl9Zn1 DG-MgAl9Zn1 MgAl8Zn MgAl8Zn
Copper, Copper Casting	C10200(B187:94) C10200(B152:94) C10200(B152:94)		C1020 B C1020 P C1020 R	OF-Cu OF-Cu OF-Cu	Cu-OF Cu-OF Cu-OF
Brass, Brass Casting	C26000(B36:95) C26000(B36:95) C26000(B36:95)		C2600 B C2600 P C2600 R	CuZn30 17660:83 CuZn30 17660:83 CuZn30 17660:83 CuZn30 17670:83	426/183 CuZn30 426/183 CuZn30 426/183 CuZn30
	C26000(B135:95) C26000(B134:93)		C2600 T C2600 W	CuZn30 CuZn30	CuZn30 CuZn30
Bronze, Bronze Casting	C61400(B169:95)		C6140 P		428:83 CuAl 8Fe3

REFERENCE

MATERIAL SYMBOL CHART BY STANDARD

(HRC) Rockwell Hardness C Scale 150kg Brale	(HV) Diamond Pyramid Hardness Number, Vickers	(HB) Brinell Hardness 29.42kN			Rockwell Hardness			Rockwell Hardness			(Hs) Shore Scleroscope Hardness Number	Approx. Tensile Strength N/mm ²	(HRC) Rockwell Hardness C Scale 150kg Brale
		Standard 10mm Ball	Hultgren 10mm Ball	Tungsten Carbide 10mm	(HRA) A Scale 588.4N (60kg) Brale	(HRB) B Scale 980.7N (100kg) 1/16" in Ball	(HRD) D Scale 980.7N (100kg) Brale	15N Superficial Load 147.1N	30N Superficial Load 294.2N	45N Superficial Load 441.3N			
68	940	—	—	—	85.6	—	76.9	93.2	84.4	75.4	97	—	68
67	900	—	—	—	85.0	—	76.1	92.9	83.6	74.2	95	—	67
66	865	—	—	—	84.5	—	75.4	92.5	82.8	73.3	92	—	66
65	832	—	—	739	83.9	—	74.5	92.2	81.9	72.0	91	—	65
64	800	—	—	722	83.4	—	73.8	91.8	81.1	71.0	88	—	64
63	772	—	—	705	82.8	—	73.0	91.4	80.1	69.9	87	—	63
62	746	—	—	688	82.3	—	72.2	91.1	79.3	68.8	85	—	62
61	720	—	—	670	81.8	—	71.5	90.7	78.4	67.7	83	—	61
60	697	—	613	654	81.2	—	70.7	90.2	77.5	66.6	81	—	60
59	674	—	599	634	80.7	—	69.9	89.8	76.6	65.5	80	—	59
58	653	—	587	615	80.1	—	69.2	89.3	75.7	64.3	78	—	58
57	633	—	575	595	79.6	—	68.5	88.9	74.8	63.2	76	—	57
56	613	—	561	577	79.0	—	67.7	88.3	73.9	62.0	75	—	56
55	595	—	546	560	78.5	—	66.9	87.9	73.0	60.9	74	2079	55
54	577	—	534	543	78.0	—	66.1	87.4	72.0	59.8	72	2010	54
53	560	—	519	525	77.4	—	65.4	86.9	71.2	58.6	71	1952	53
52	544	500	508	512	76.8	—	64.6	86.4	70.2	57.4	69	1883	52
51	528	487	494	496	76.3	—	63.8	85.9	69.4	56.1	68	1824	51
50	513	475	481	481	75.9	—	63.1	85.5	68.5	55.0	67	1755	50
49	498	464	469	469	75.2	—	62.1	85.0	67.6	53.8	66	1687	49
48	484	451	455	455	74.7	—	61.4	84.5	66.7	52.5	64	1638	48
47	471	442	443	443	74.1	—	60.8	83.9	65.8	51.4	63	1579	47
46	458	432	432	432	73.6	—	60.0	83.5	64.8	50.3	62	1530	46
45	446	421	421	421	73.1	—	59.2	83.0	64.0	49.0	60	1481	45
44	434	409	409	409	72.5	—	58.5	82.5	63.1	47.8	58	1432	44
43	423	400	400	400	72.0	—	57.7	82.0	62.2	46.7	57	1383	43
42	412	390	390	390	71.5	—	56.9	81.5	61.3	45.5	56	1334	42
41	402	381	381	381	70.9	—	56.2	80.9	60.4	44.3	55	1294	41
40	392	371	371	371	70.4	—	55.4	80.4	59.5	43.1	54	1245	40
39	382	362	362	362	69.9	—	54.6	79.9	58.6	41.9	52	1216	39
38	372	353	353	353	69.4	—	53.8	79.4	57.7	40.8	51	1177	38
37	363	344	344	344	68.9	—	53.1	78.8	56.8	39.6	50	1157	37
36	354	336	336	336	68.4	(109.0)	52.3	78.3	55.9	38.4	49	1118	36
35	345	327	327	327	67.9	(108.5)	51.5	77.7	55.0	37.2	48	1079	35
34	336	319	319	319	67.4	(108.0)	50.8	77.2	54.2	36.1	47	1059	34
33	327	311	311	311	66.8	(107.5)	50.0	76.6	53.3	34.9	46	1030	33
32	318	301	301	301	66.3	(107.0)	49.2	76.1	52.1	33.7	44	1000	32
31	310	294	294	294	65.8	(106.0)	48.4	75.6	51.3	32.5	43	981	31
30	302	286	286	286	65.3	(105.5)	47.7	75.0	50.4	31.3	42	951	30
29	294	279	279	279	64.7	(104.5)	47.0	74.5	49.5	30.1	41	932	29
28	286	271	271	271	64.3	(104.0)	46.1	73.9	48.6	28.9	41	912	28
27	279	264	264	264	63.8	(103.0)	45.2	73.3	47.7	27.8	40	883	27
26	272	258	258	258	63.3	(102.5)	44.6	72.8	46.8	26.7	38	863	26
25	266	253	253	253	62.8	(101.5)	43.8	72.2	45.9	25.5	38	843	25
24	260	247	247	247	62.4	(101.0)	43.1	71.6	45.0	24.3	37	824	24
23	254	243	243	243	62.0	100.0	42.1	71.0	44.0	23.1	36	804	23
22	248	237	237	237	61.5	99.0	41.6	70.5	43.2	22.0	35	785	22
21	243	231	231	231	61.0	98.5	40.9	69.9	42.3	20.7	35	775	21
20	238	226	226	226	60.5	97.8	40.1	69.4	41.5	19.6	34	755	20
(18)	230	219	219	219	—	96.7	—	—	—	—	33	736	(18)
(16)	222	212	212	212	—	95.5	—	—	—	—	32	706	(16)
(14)	213	203	203	203	—	93.9	—	—	—	—	31	677	(14)
(12)	204	194	194	194	—	92.3	—	—	—	—	29	647	(12)
(10)	196	187	187	187	—	90.7	—	—	—	—	28	618	(10)
(8)	188	179	179	179	—	89.5	—	—	—	—	27	598	(8)
(6)	180	171	171	171	—	87.1	—	—	—	—	26	579	(6)
(4)	173	165	165	165	—	85.5	—	—	—	—	25	549	(4)
(2)	166	158	158	158	—	83.5	—	—	—	—	24	530	(2)
(0)	160	152	152	152	—	81.7	—	—	—	—	24	520	(0)

In the above chart, figures with () are not commonly used.

REFERENCE

INDEX



LIST NUMBER INDEX

DRILLS

List Number	Description	Product Page	Cutting Condition Page	List Number	Description	Product Page	Cutting Condition Page
	Drill Visual Index	12-21		9610	Aqua EX Flat Stub, Metric	96-97	99
	Drill Selection Chart	50-57		9611	Aqua EX Flat, Fractional	96-97	99
500	Straight Shank Jobber Length, Metric	130	148	9612	Aqua EX Oil Hole 10D	72	75
501	Straight Shank Jobber Length, Fractional	131	148	9614	Aqua EX Oil Hole 15D, Metric	73	75
501A	Straight Shank Jobber Length, Bright	129	148	9615	Aqua EX Oil Hole 15D, Fractional	73	75
501P	Straight Shank Jobber Length, Tin Coated	135	148	9616	Aqua EX Oil Hole 20D, Metric	74	75
517P	Straight Shank Jobber Length, Parabolic	136	149	9617	Aqua EX Oil Hole 20D, Fractional	74	75
520P	Straight Shank G Standard, Metric	134	148	9618	Aqua EX Oil Hole 25D, Metric	76	78
531	Straight Shank Taper Length, Fractional	137	148	9619	Aqua EX Oil Hole 25D, Fractional	76	78
544	DLC Drill, Metric	123	124	9620	Aqua EX Oil Hole 30D, Metric	77	78
545P	Straight Shank Taper Length, Tin Coated	139	149	9621	Aqua EX Oil Hole 30D, Fractional	77	78
551	Straight Shank Extra Length	140	149	9622	Aqua EX Oil Hole Pilot, Metric	81-82	82
561	Screw Machine Length, Bright	123	148	9623	Aqua EX Oil Hole Pilot, Fractional	81-82	82
561P	Screw Machine Length, Tin Coated	126	148	9624	Aqua EX Starting Drill	109	109
563	Screw Machine Length, Aircraft	127	148	9626	Aqua EX Oil Hole 40D, Metric	79	80
575	Silver and Deming	146	150	9627	Aqua EX Oil Hole 40D, Fractional	79	80
581	Straight Shank Oil Hole	142	150	9628	Aqua EX Flat Super Stub, Metric	81-82	82
599	Drill Set Jobber Length	147		9812	Aqua EX Flat Oil Hole 3D, Metric	103-104	104
601	Taper Shank Regular, Fractional	143	150	9813	Aqua EX Flat Oil Hole 3D, Fractional	103-104	104
651	Taper Shank Extra Length	144	150	9814	Aqua EX Flat Oil Hole 5D, Metric	105-106	104
683	Taper Shank Oil Hole	145	150	9815	Aqua EX Flat Oil Hole 5D, Fractional	105-106	104
6501	Straight Shank Jobber Length, Aircraft	132	148	9816	Aqua EX Flat Long, Metric	101	102
6502	AG Starting Drill	110	109	9817	Aqua EX Flat Long, Fractional	101	102
6504	AG Starting Drill Extended Length	110	109	9818	Aqua EX Flat Regular, Metric	100	102
6520	Straight Shank Jobber Length, Cobalt	133	148	9819	Aqua EX Flat Regular, Fractional	100	102
6531	Straight Shank Taper Length, Cobalt	138	148	9820	Aqua EX Oil Hole 3-Flute 5D	84	84
6540P	AG Power Long Drill, Metric	121	122	9826	Aqua EX Oil Hole 3-Flute 3D	83	84
6541P	AG Power Long Drill, Fractional	121	122	9830	Aqua EX Flat Radius, Metric	98	99
6551	Straight Shank Extra Length Parabolic	141	149	9831	Aqua EX Flat Radius, Fractional	98	99
6563	Screw Machine Length, Cobalt	128	148	9860	Aqua REVO Drill Stub, Metric	58-59	59
7572P	Mic SG-ESS Micro	111-116	116	9861	Aqua REVO Drill Stub, Fractional	58-59	59
7572P	SG-ESS Stub Length, Metric	111-116	116	9862	Aqua REVO Drill Regular, Metric	60-61	61
7573P	SG-ESS Stub Length, Fractional	111-116	116	9863	Aqua REVO Drill Regular, Fractional	60-61	61
7574P	SG-ESR, Metric	117-118	119	9872	Aqua REVO Drill Oil Hole 3D, Metric	62-63	63
7575P	SG-ESR, Fractional	117-118	119	9873	Aqua REVO Drill Oil Hole 3D, Fractional	62-63	63
7591P	SG with Oil Hole, Fractional	120	120	9874	Aqua REVO Drill Oil Hole 5D, Metric	66-67	67
7596P	SG with Oil Hole, Metric	120	120	9875	Aqua REVO Drill Oil Hole 5D, Fractional	66-67	67
9520	DLC Regular, Metric	94	95	9868	Aqua REVO Drill Oil Hole 8D, Metric	70-71	71
9524	DLC Micro, Metric	94	95	9869	Aqua REVO Drill Oil Hole 8D, Fractional	70-71	71
9544	Aqua Micro, Metric	90	91	9878	Aqua REVO Drill Micro 5D	86-87	87
9604	Aqua EX Oil Hole 3D, Metric	93	93	9880	Aqua REVO Drill Micro 10D	88-89	89
9606	Aqua EX Oil Hole 5D, Metric	93	93				

END MILLS

List Number	Description	Product Page	Cutting Condition Page
	End Mill Visual Index	22-25	
	End Mill Selection Chart	158-161	
6210	4-Flute Regular Single End, Metric	200	203
6211M	Multi-Flute Regular Single End	201	203
6211X	Multi-Flute Regular Single End, SG Coated	201	204
6213	Multi-Flute Long Single End	202	203
6230	2-Flute Regular Single End, Metric	198	199
6231	2-Flute Regular Single End, Fractional	197	199
6231HD	DLC Drill, Fractional	189	189
6231X	2-Flute Regular Single End, SG Coated	197	199
6233	2-Flute Long Single End	198	199
6303	Roughing (HOG)	194	196
6303X	Roughing (HOG), SG Coated	194	196
6307	Roughing (HOG), Multi-Flute	195	196
6367	Roughing & Finishing (HD)	192	193
6367X	Roughing & Finishing (HD), SG Coated	192	193
6403	AG-Mill Heavy	191	191
6485	AG-Mill Roughing	190	190
9701	Aqua V Mill 4-Flute, Fractional	162	169-170
9702	Aqua V Mill 4-Flute, Metric	162	169-170
9703	Aqua V Mill 4-Flute CR, Fractional	163	169-170
9704	Aqua V Mill 4-Flute CR, Metric	163	169-170
9705	Aqua V Mill 5-Flute, Fractional	164	169
9706	Aqua V Mill 5-Flute, Metric	164	169
9707	Aqua V Mill 5-Flute CR, Fractional	165-166	169
9708	Aqua V Mill 5-Flute CR, Metric	165-166	169
9709	Aqua V Mill 5-Flute BN, Fractional	168	169
9710	Aqua V Mill 5-Flute BN, Metric	168	169
9711	Aqua Mill Hard SE, Fractional	171	175-176
9712	Aqua Mill Hard SE, Metric	171	175-176
9713	Aqua Mill Hard CR, Fractional	172	175-176
9714	Aqua Mill Hard CR, Metric	172	175-176
9715	Aqua Mill Hard BN, Fractional	173	177-178
9716	Aqua Mill Hard BN, Metric	173	177-178
9717	ALH SE, Fractional	179	185-186
9718	ALH SE, Metric	179	185-186
9719	ALH CR, Fractional	180-181	185-186
9720	ALH CR, Metric	180-181	185-186
9721	ALH BN, Fractional	182	185-186
9722	ALH BN, Metric	182	185-186
9723	ALH Mill SE Neck Relief, Fractional	183	185-188
9725	ALH Mill BN Neck Relief, Fractional	184	185-188
9727	Aqua V Mill 5-Flute Neck Relief, Fractional	167	169
9729	Aqua Mill Hard CR Neck Relief, Fractional	174	175-178
9730	Aqua Mill Hard CR Neck Relief, Metric	174	175-178

TAPS

List Number	Description	Product Page	Cutting Condition Page
	Tap Visual Index	26-28	
	Tap Selection Chart	218-221	
910	Standard Hand, Metric	240	244
911	Standard Hand, Fractional	236	244
913	Standard Hand, Machine Screw	237	244
920	Standard Spiral, Metric	240	244
921	Standard Spiral Pointed, Fractional	238	244
923	Standard Spiral Pointed, Machine Screw	239	244
941	Taper Pipe Straight Flute (NPT)	241	244
941D	Taper Pipe Straight Fluted (NPTF)	241	244
943	Taper Pipe Interrupted (NPT)	241	244
943D	Taper Pipe Interrupted (NPTF)	241	244
945	Straight Pipe Straight Fluted (NPS)	242	244
945D	Straight Pipe Straight Fluted (NPSF)	241	244
947	Taper Pipe Spiral Fluted (NPT)	242	244
947D	Taper Pipe Spiral Fluted (NPTF)	242	244
957	Taper Pipe Short Projection (NPT)	243	244
959	Taper Pipe Short Projection (NPT)	243	244
959D	Taper Pipe Short Projection (NPTF)	243	244
969	Standard Hand for Cast Iron	238	244
971	VTP Spiral Pointed, Fractional	235	235
973	VTP Spiral Pointed, Machine Screw	235	235
980	VTP Spiral Fluted, Metric	233	235
981	VTP Spiral Fluted, Fractional	234	235
982	VTP Spiral Pointed, Metric	233	235
983	VTP Spiral Fluted, Machine Screw	234	235
995	Viper Taflet for Steel, Fractional & M.S.	231-232	231-232
996	Viper Taflet for Steel, Metric	230	231
6800	SGSP-DIN Spiral Pointed Tap, Metric	222-223	222
6801	SGSP-DIN Spiral Fluted Tap, Fractional & M.S.	222-223	220
6802	SGSPO-DIN Spiral Pointed Tap, Metric	224-225	224
6803	SGSPO-DIN Spiral Pointed Tap, Fractional & M.S.	224-225	224
6955	DLC Taflet Thread Forming, Fractional	228-229	228
6956	DLC Taflet Thread Forming, Metric	228-229	228
6957	DLC Taflet Thread Forming, Machine Screw	228-229	228
6958	SG Lo-Spiral Fluted, Metric	226-227	226
6959	SG Lo-Spiral Fluted, Fractional & M.S.	226-227	226

NACHI CONVERSION TABLE

Decimal	Fraction	Wire, Letter	mm	Tap Sizes To be used with drills as indicated	Decimal	Fraction	Wire, Letter	mm	Tap Sizes To be used with drills as indicated	Decimal	Fraction	Wire, Letter	mm	Tap Sizes To be used with drills as indicated	Decimal	Fraction	Wire, Letter	mm	Tap Sizes To be used with drills as indicated
.0059	97	.15			.0610			1.55		.1614			4.1		.3071			7.8	M9x1.25
.0063	96	.16			.0625	1/16				.1654			4.2	M5x0.8	.3110			7.9	
.0067	95	.17			.0630			1.6	M2x0.4	.1660		19			.3125	5/16			3/8-16
.0071	94	.18			.0635		52			.1693			4.3		.3150			8.0	
.0075	93	.19			.0650			1.65		.1695			18		.3160		O		
.0079	92	.2			.0669			1.7		.1719	11/64				.3189			8.1	
.0083	91				.0670		51			.1730			17		.3228			8.2	
.0087	90	.22			.0689			1.75	M2.2x0.45	.1732			4.4		.3230		P		
.0091	89				.0700				No.2-56	.1770			16	No.12-24	.3268			8.3	
.0095	88								No.2-64	.1772			4.5		.3281	21/64			3/8-20
.0098		.25			.0709			1.8		.1800			15		.3307			8.4	
.0100	87				.0728			1.85		.1811			4.6		.3320		Q		
.0105	86				.0730					.1820			14	No.12-28	.3346			8.5	M10x1.5
.0110	85	.28			.0748			1.9		.1850			13	No.12-32	.3386			8.6	
.0115	84				.0760		48			.1875	3/16				.3390		R		3/8-24
.0118		.3			.0768			1.95		.1890			12	4.8	.3425			8.7	
.0120	83				.0781	5/64				.1910			11		.3438	11/32			3/8-28
.0125	82				.0785		47			.1929			4.9						3/8-32
.0126		.32			.0787			2.0		.1935			10		.3465			8.8	
.0130	81				.0807			2.05	M2.5x0.45	.1960			9		.3480		S		
.0135	80				.0810		46			.1969			5.0	M6x1	.3504			8.9	
.0138		.35			.0820		45		No.3-56	.1990			8		.3543			9.0	
.0145	79				.0827			2.1		.2008			5.1		.3580		T		
.0150		.38			.0846			2.15		.2010			7	1/4-20	.3583			9.1	
.0156	1/64				.0860		44			.2031	13/64				.3594	23/64			
.0157		.4			.0866			2.2		.2040			6		.3622			9.2	
.0160	78				.0886			2.25		.2047			5.2		.3661			9.3	
.0177		.45			.0890		43		No.4-40	.2055			5		.3680		U		7/16-14
.0180	77				.0906			2.3		.2087			5.3		.3701			9.4	
.0197		.5			.0925			2.35		.2090			4		.3740			9.5	
.0200	76				.0935		42		No.4-48	.2126			5.4		.3750	3/8			7/16-16
.0210	75				.0938	3/32				.2130			3		.3770		V		
.0217		.55			.0945			2.4		.2165			5.5		.3780			9.6	
.0225	74				.0960		41			.2188	7/32			1/4-28	.3819			9.7	
.0236		.6			.0965			2.45		.2205			5.6	1/4-32	.3858			9.8	
.0240	73				.0980		40			.2210			2		.3860		W		
.0250	72				.0984			2.5	M3x0.5	.2220			5.7		.3898			9.9	
.0256		.65			.0995		39			.2244			5.7		.3906	25/64			7/16-20
.0260	71				.1015		38		No.5-40	.2280			1		.3937			10.0	
.0276		.7			.1024			2.6		.2283			5.8		.3970		X		
.0280	70				.1040		37		No.5-44	.2323			5.9		.4016			10.2	M12x1.75
.0292	69				.1063			2.7		.2340		A			.4040		Y		7/16-28
.0295		.75			.1065		36		No.6-32	.2344	15/64				.4062	13/32			7/16-32
.0310	68				.1094	7/64				.2362			6.0	M7x1	.4130		Z		
.0312	1/32				.1100		35			.2380		B			.4134			10.5	
.0315		.8			.1102			2.8		.2402			6.1		.4219	27/64			1/2-13
.0320	67				.1110		34			.2420		C			.4252			10.8	
.0330	66				.1130		33		No.6-40	.2441			6.2		.4331			11.0	
.0335		.85			.1142			2.9	M3.5x0.6	.2460		D			.4375	7/16			1/2-16
.0350	65				.1160		32			.2480			6.3		.4409			11.2	
.0354		.9			.1181			3.0		.2500	1/4	E			.4528			11.5	
.0360	64				.1200		31			.2520			6.4		.4531	29/64			1/2-20
.0370	63				.1220			3.1		.2559			6.5		.4646			11.8	
.0374		.95			.1250	1/8				.2570		F							1/2-28
.0380	62				.1260			3.2		.2598			6.6		.4688	15/32			1/2-32
.0390	61				.1285		30			.2610		G			.4724			12.0	M14x2
.0394		1.0			.1299			3.3	M4x0.7	.2638			6.7		.4803			12.2	
.0400	60				.1339			3.4		.2656	17/64				.4844	31/64			9/16-12
.0410	59								No.8-32	.2660		H			.4921			12.5	
.0413		1.05			.1360		29		No.8-36	.2677			6.8	M8x1.25	.5000	1/2			9/16-16
.0420	58				.1378			3.5		.2717			6.9		.5039			12.8	
.0430	57				.1405		28			.2720		I			.5118			13.0	
.0433		1.1			.1406	9/64				.2756			7.0		.5156	33/64			9/16-18
.0453		1.15			.1417			3.6		.2770		J			.5197			13.2	9/16-20
.0465	56				.1440		27			.2795			7.1						
.0469	3/64				.1457			3.7	M4.5x0.75	.2810		K			.5312	17/32			9/16-24
.0472		1.2			.1470		26			.2812	9/32								9/16-28
.0492		1.25			.1495		25		No.10-24	.2835			7.2						9/16-32
.0512		1.3			.1496			3.8		.2874			7.3						5/8-11
.0520	55				.1520		24			.2900		L			.5315			13.5	
.0531		1.35			.1535			3.9		.2913			7.4		.5433			13.8	
.0550	54				.1540		23			.2950		M			.5469	35/64			5/8-12
.0551		1.4			.1562	5/32				.2953			7.5		.5512			14.0	M16x2
.0571		1.45			.1570		22			.2969	19/64				.5610			14.25	
.0591		1.5			.1575			4.0		.2992			7.6		.5625	9/16			5/8-16
.0595	53				.1590		21		No.10-32	.3020		N			.5709			14.5	
					.1610		20			.3031			7.7						

NACHI

NACHI AMERICA INC.

CUTTING TOOL PRODUCTS

HEADQUARTERS AND MAIN WAREHOUSE

715 Pushville Road, Greenwood, Indiana 46143, U.S.A.
Phone (317) 530-1003 Toll Free Phone (888) 340-8665
Fax (317) 530-1013 Toll FreeFax (888) 383-8665
NachiAmerica.com

LOS ANGELES BRANCH

12652 E Alondra Boulevard, Cerritos, California 90703, U.S.A.
Phone (562) 802-0055 Toll Free Phone (800) 548-3903
Fax (562) 802-2455

LATIN AMERICA/MIAMI BRANCH

2301 NW 107th Avenue, Suite 108, Doral, FL 33172, U.S.A.
Phone (305) 591-0054

NACHI CANADA INC.

89 Courtland Avenue, Unit 2, Concord, Ontario, Canada L4K 3T4
Phone (905) 660-0088 Toll Free Phone (800) 387-9188
Fax (905) 660-1146

NACHI MEXICANA, S.A. DE C.V.

Calle Tequisquiapan 2, Aerotech Industrial Park, Localidad Galeras
Municipio de Colón, Queretaro, Mexico C.P. 76295
Phone +52 (442) 153-2424
Fax +52 (442) 153-2435

NACHI'S OTHER QUALITY PRODUCTS

BEARINGS

Phone (317) 530-1002 Toll Free Phone (888) 340-2747
Fax (317) 530-1012 Toll Free Fax (888) 383-8665

BROACH/GEAR TOOLS

Phone (317) 530-1004
Fax (317) 530-1014

HYDRAULICS

Phone (317) 530-1005 Toll Free Phone (800) 622-4410
Fax (317) 530-1015
Fax (248) 305-6542

MACHINERY

Phone (248) 305-6545

MATERIALS

Phone (317) 530-1006 Toll Free (800) 526-6281
Fax (317) 530-1015

ROBOTICS

Phone (248) 305-6545 Fax (248) 305-6542